

# IZELTAS®



OCAK  
2025



# ÇALIŞMA LAMBALARI İŞİNİZİ AYDINLATSIN



1 | 600 LM Cob Led Çalışma Lambası  
600 LM Cob Led Work Light

2 | 400 LM Cob Led Çalışma Lambası  
400 LM Cob Led Work Light

3 | 200 LM Cob Led Çalışma Lambası  
200 LM Cob Led Work Light

4 | 400 LM Cob Led Katlanır Çalışma Lambası  
400 LM Cob Led Rotating Work Light

5 | 300 LM Cob Led Kalem Tipi Fener  
300 LM Pro Led Pen Light



**A - KAPSAM İÇİ**

1. Normal kullanım şartlarına uygun kullanılan ancak, imalat veya malzeme hatası tespit edilen ürünler, ömür boyu garanti kapsamında, tamir edilir veya mümkün değilse, derhal yenisi ile değiştirilir.

**B - KAPSAM DIŞI**

Aşağıda yazılı şartlarda kullanılan aletler, garanti kapsamı dışında olup, yenisi ile değiştirilmezler.

1. Kullanım amacı veya kullanma talimatı dışında kullanılmış olan ürünler.
2. Aşırı zorlama ile, boru takılarak veya çekiçle vurularak darbeli kullanım sonucu deforme olmuş ya da kırılmış olan ürünler.
3. Kullanıcı tarafından üzerinde taşlama, zımparalama, delme veya kaynak yapılarak orijinal hali bozulmuş olan ürünler.
4. Kullanıldıktan sonra, gerekli koruyucu bakımları yapılmadan, tozlu, rutubetli ve çamurlu ortamlarda bekletilerek fonksiyonu kaybolmuş ürünler.
5. Uygun olmayan rutubetli ortamlarda, uzun süre stoklanarak, paslanmış, korozyona uğramış olanlar.
6. Uzun süre kullanılmış veya kullanım ömrünü tamamlamış, buna bağlı olarak eskimiş, yıpranmış, deforme olmuş ürünler.

**EMNİYETLİ VE DOĞRU EL ALETİ KULLANIM KURALLARI****A - UYULMASI GEREKEN KURALLAR:**

1. Anahtarın ölçüsünün kullandığınız parçaya göre uygun olduğundan emin olunuz.
2. Kullanım esnasında aletin doğru şekilde yerleştirildiğinden emin olunuz.
3. Aleti sık kontrol ediniz. Aşınmış, zarar görmüş aletleri değiştiriniz.
4. Aleti kullanım şartlarına uygun olarak kullanınız, aşırı yük uygulamayınız.
5. Özellikle çekiçlerde vurma yüzeyinin, vurulan yüzeyden daha büyük olmak zorunda olduğuna dikkat ediniz.
6. Havalı aletlerde daima uygun aksesuarı kullanınız. (Ayrıca basınçlı havanın yağlandığından emin olunuz.)
7. Çalışma şartlarına göre uygun kişisel koruma teçhizatı kullanınız.
8. Tekerlekli takım dolaplarını, daima kapılarını ve hareketli bölümlerini kilitledikten sonra hareket ettiriniz.
9. Tekerlekli takım dolabı üzerinde çalışırken, tekerleklerini frenleyiniz.
10. Yüksek gerilimli çalışma ortamlarında TS EN IEC 60900 Standartına uygun olarak üretilmiş VDE belgeli ürünleri kullanınız.
11. Aletlerin nemli ve ıslak ortamlarda kullanımı ardından mutlaka kurutunuz ve hafif yağlayınız.

**B - YAPILMAMASI GEREKEN İŞLEMLER:**

1. Boru vb. uzatmalar kullanılarak olması gereken tork gücünü aşmayınız. (Özellikle tüm anahtarlarda)
2. Hiçbir aleti üretim maksadına aykırı işlerde kullanmayınız. (örneğin: tornavidanın levye veya keski gibi kullanımı)
3. Aşırı güç uygulayarak (boru takarak veya çekiçle vurarak) aleti zorlamayınız. (örneğin: anahtarlar ve tornavidalar)
4. Hiçbir zaman, kullandığınız aleti kendinden daha sert olan bir cisme vurmeyiniz. (örneğin: çekiç ve keskiler)
5. Aletleri değişikliğe uğratmayınız. (Şekli veya bir kısmını)
6. Metrik ölçülü anahtarları, inch ölçülü civatalarda kullanmayız veya tersini yapmayınız.
7. Yıpranmış ve hatalı aletleri kullanmayınız.
8. Tekerlekli tamir dolabı dolu iken, birden fazla çekmeceyi açık tutmayınız, çekmeceler açıkken hareket ettirmeyiniz.
9. Aletin fonksiyonunu iyileştirmek maksadı ile üzerinde zımpara, taş, kaynak vb. işlem yapmayınız.
10. Aletin kullanımı sırasında boya veya kaplamanın çıkacağı etkilere maruz bırakmayınız. Aksi halde korozyon dayanımı negatif etkilenecektir.
11. İzolasyonu zedelenmiş, sapı yıpranmış VDE sertifikalı ürünleri hiçbir şekilde yüksek gerilim ihtiva eden ortamlarda kullanmayınız.
12. Kontrol kaleminin iç mekanizmasını kesinlikle sökmeye çalışmayınız. Kontrol kalemleri 110 – 250 VAC çalışma aralığı için uygundur.
13. Yukarıda bahsedilen şartlara ve doğru kullanıma riayet ederek, her zaman amaca yönelik uygun aletleri kullanınız.

**A - INCLUDED CASES**

1. Products used in accord with normal use conditions but found to have production or material errors will be repaired or if this is not possible replaced immediately under lifetime warranty.

**B - EXCLUDED CASES**

Products used under any of the conditions listed below are excluded from the warranty scope and cannot be replaced with new ones:

1. Products used outside the intended purpose or instructions of use;
2. Products deformed or broken due to excessive forcing, pipe attachment or hammer impact;
3. Products whose original form is altered by the user by stoning, grinding, perforation or welding;
4. Products which lost their function due to being left in dusty, moist or muddy environments without necessary protective maintenance after use;
5. Products which became rusted or corroded due to being stored in unsuitable, moist environments for extended periods of time;
6. Products which are used for a long period of time or which have completed their useful life and accordingly have become old, worn out and deformed.

**RULES FOR SAFE AND CORRECT USE OF HAND TOOL****A - PRACTICAL RULES:**

1. Make sure size of the wrench is appropriate for the work piece.
2. Make sure the tool is positioned correctly during use.
3. Frequently control the tool. Replace worn or damaged tools.
4. Use the tool in accord with instructions of use. Do not place too much load on the tool.
5. Especially beware of the point that the impact surface of a hammer must be larger than the impacted surface.
6. Always use appropriate accessories for pneumatic tools. (Also make sure the pneumatic system is properly lubricated.)
7. Use personal protection equipment appropriate for work conditions.
8. Always make sure to lock lids and moving parts of wheeled set cabinets before moving them.
9. Make sure to lock brakes of the wheeled set cabinets before working on them.
10. Use VDE certified products made in accord with TS EN IEC 60900 Standard in high voltage work environments.
11. Make sure to dry and lightly lubricate tools after use in moist and wet environments.

**B- ACTIONS TO AVOID:**

1. In case of use with extensions like pipes, etc. do not exceed the specified torque value (especially in case of all wrenches).
2. Do not use any tool outside of its intended purpose (e.g. do not use a screwdriver as a lever or a chisel).
3. Do not force the tool (e.g. wrenches and screwdrivers) by using excessive force (by pipe attachment or hammer impact).
4. Never use the tool to hit another object harder than the tool (e.g. hammer and chisels).
5. Do not alter the tools (in form or partially).
6. Do not use metric sized wrenches on inch sized bolts or vice-versa.
7. Do not use worn out or faulty tools.
8. Do not leave multiple drawers open when using the wheeled set cabinet and do not move the cabinet while the drawers are open.
9. Do not perform grinding, stoning, welding, etc. on the tool in order to improve its function.
10. Do not expose the tool to conditions that might result in loss of paint or coating during use. Otherwise corrosion resistance of the tool will be affected.
11. Never use VDE certified products with damaged or worn isolation or handle in high voltage work environments.
12. Never attempt to dismantle the internal assembly of the tester. Testers are suitable for use in the 110 – 250 VAC operation range.
13. Always use the right tool for the right job and follow the conditions and rules of correct usage detailed above.

## Yarım asırlık 'güven'

### Kalite yolculuğu inanmakla başlar.

Türkiye'nin ilk ve en büyük el aletleri üreticisi İZELTAŞ, 1968 yılında Ege'nin gözbebeği İzmir'den işte bu inançla yola çıktı. Yüzde 100 Türk sermayesiyle oluşturulan ve günden güne büyüyen İZELTAŞ, modern teknolojiyle donatılmış dev tesislerinde üretilen dört bin beş yüz den fazla ürünle 40 ülkeye ihracat yaparak hem kendi insanına hem de ülke ekonomisine katkı sağlıyor.

El aletlerinin yanı sıra üretilen dövme parçalar ile başta otomotiv olmak üzere inşaat, denizcilik ve madencilik sektörüne, savunma ve havacılık sanayilerine, ziraat endüstrisine, altyapı işlerine dek birçok kamu ve özel sektör kuruluşuna hizmet sunuyor.

### Daha iyisi, daha yenisi için...

Kalıphane, dövme, işleme, ısıtma işlemi, krom-nikel kaplama, boyama, plastik daldırma, plastik enjeksiyon ve markalama departmanlarından oluşan dünyadaki ender entegre fabrikalardan İZELTAŞ'ta üretimin her aşamasında kalite kontrolüne tabi tutulan ürünler; fiziksel, metalürjik, kimyasal ve elektriksel testlerden geçirilerek İZELTAŞ güvencesine alınıyor. Ar-Ge ve inovasyon ışığında değişime ve gelişime her daim açık olan İZELTAŞ, bu sayede gücüne güç katıyor.

T.C. Sanayi ve Teknoloji Bakanlığında AR-GE Merkezi belgesine sahip İZELTAŞ, TS EN ISO 9001 Kalite Yönetim Sistemi, ISO/IEC 27001 Bilgi Güvenliği Yönetim Sistemi, TS (OHSAS) 18001 İş Sağlığı ve Güvenliği Yönetim Sistemi, TS EN ISO 14001 Çevre Yönetim Sistemi, TS EN ISO 50001 Enerji Yönetim Sistemleri; TSE, TSEK, VDE GS ürün kalite belgeleri ve yüksek teknolojisi ile sadece Türkiye'de değil, dünyada da farkını ortaya koyuyor.

### Önce güvenlik, sonra üretim

İnsan önemli, emek değerlidir. İZELTAŞ, "Önce güvenlik" anlayışından ayrılmadan, çalışanları için önlem almaya, onları iş sağlığı ve güvenliği konusunda eğitmeye devam ediyor. Çünkü; "İnsan vücudunun yedek parçası yoktur"

### Size ulaştıktan sonra...

Satış sonrasında tüketici haklarını koruma ve sınırsız hizmet anlayışı İZELTAŞ'ın vazgeçilmez şirket politikalarından birini oluşturuyor.

Dolayısıyla...

- El aletleri' dendiğinde akla gelen ilk isim olabildiysek,
- Yarım asırdır 'aileden biri' olmanın hakkını verebildiysek,
- 'Türk malı' sözünün altına imzamız atabildiysek,
- 'Yıllarca kullanılır' diyerek her zaman tercih edildiysek,

Gücümüzü, şevkimizi ve inancımızı siz değerli bayilerimiz ve tüketicilerimizden alıyoruz.

850 çalışanımızla birlikte üreterek, değer sağlayarak dünya markası olmanın haklı gururunu yaşıyoruz.

Nice başarılı yıllara!

## Half a century of reliability

### Faith is the essential step on the journey to achieve utmost quality.

As the first and largest hand tool manufacturer of Turkey, İZELTAŞ, had this faith as it started its journey in 1968 in İzmir, the beautiful city in the Aegean region. Its establishment, consisting of 100% national capital, İZELTAŞ has grown in years into an industrial giant with huge facilities equipped with state-of-the-art technologies and over 4500 products. Exporting to more than 40 countries, the company is a prominent contributor to not only the Turkish economy but also the community.

Along with manufacturing hand tools, İZELTAŞ produces forged steel parts for various industries like automotive, construction, maritime, mining, aviation, defence, agriculture and infrastructure.

### Newer and better

İZELTAŞ is one of the few fully integrated factories in the world that consists of die tooling, forging, processing, heat processing, chrome-nickel plating, dyeing, pvc coating, plastic injection and marking departments. Every stage of the production is tested for quality assurance using physical, metallurgical, chemical and electrical methods. R&D and innovation are the key words that empower İZELTAŞ as a company which embraces development and improvement as its main philosophy.

İZELTAŞ is an accredited R&D Center by the Ministry of Science, Industry and Technology and has been certified with the following: ISO 9001 Quality Management System, ISO/IEC 27001 Informationsecurity Maniagement System, OHSAS 18001 Occupational Health and Safety Management System, ISO 14001 Environment Management System, ISO 50001 Energy Management System certification, TSE, TSEK and VDE GS product certification.

### Safety before production

Humans are the most significant factors of any industry and their labour is precious. Health and safety awareness is the fundamental policy of İZELTAŞ. The company continuously organizes training programs on occupational health and safety which emphasise that safety comes first and it is not possible to fix humans by changing the damaged organs with spare ones.

### Customer satisfaction

Another fundamental policy of İZELTAŞ is the customer satisfaction. The company is dedicated to serve its customers and protect their rights as consumers.

Hence...

















- We are the first brand that comes to mind in the hand tools industry
- We are valued almost as a part of the families of our consumer
- We have proved ourselves worthy of the statement "Made in Turkey"
- We have been the first choice of the consumers for durability over the years

Our power, enthusiasm and faith are derived from our distinguished dealers and consumers.

We are proud to have become a world brand with our 850 employees who strive everyday to contribute to the productivity of the company, creating an added value for the economy and our community.

To many successful years to come!



Takım Dolapları ve Takım Çantaları / Tool Trolleys, Tool Boxes	5-69	
Anahtarlar / Wrenches	70-90	
Lokma ve Bijon Anahtarları / Sockets and Rim Wrenches	91-118	
Havalı Lokma Anahtarlar / Air Pressured Sockets and Rim Wrenches	119-127	
Boru Anahtarları ve Penseler / Pipe Wrenches and Pliers	129-146	
1000V Grubu Ürünler / 1000V Product Group	147-159	
Tornavida ve Allen Anahtarlar / Screwdrivers and Hex Key Wrenches	161-186	
Keskiler ve Çekiçler / Chisels and Hammers	187-194	
Genel El Aletleri / General Hand Tools	195-211	
Aydınlatma / Lighting	212-217	
Maket Bıçakları / Utility Knives	218-222	
Makaslar / Shears	223-230	
Çektirmeler / Pullers	231-237	
Elta Ürünleri / Elta Products	239-254	<b>elta</b>
Yedek Parçalar / Spare Parts	255-259	
Ticari Teşhir Standları / Commercial Display Stands	261-264	
Teknik Bilgiler / Technical Information	265-274	



*"Sadece el aleti üretmiyoruz;  
el aletleriyle her şeyi üretiyoruz."*

*"We don't just produce hand tools;  
we build everything with hand tools."*



# TAKIM DOLAPLARI, TAKIM ÇANTALARI VE ALET SETLERİ

TOOL TROLLEYS, TOOL BOXES AND HAND TOOL SETS

- Takım Dolapları  
Tool Cabinets
- Soyunma Dolapları  
Lockers
- Taşıma Arabaları  
Tool Trolleys
- Servis Masaları  
Service Tables
- Takım Çantaları  
Tool Boxes
- Alet Setleri  
Tool Sets
- Bez Takım Çantaları  
Tool Bags

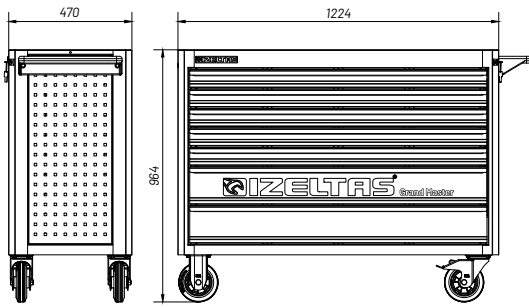

**Grand Master Seri Takım Dolabı (7 Çekmeceli)**  
**Grand Master Series Workshop Trolley (7 Drawers)**
**YENİ  
NEW**

**Ölçü/Size: 470x1224x964 mm**

- ✓ 18mm masif üst tabla
- 18 mm solid wood top

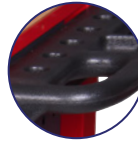

- ✓ Ergonomik sap
- Ergonomic handle



- ✓ %100 açılabilir teleskobik raylar
- %100 extendable telescopic slides



- ✓ 2 sabit, 2 hareketli frenli tekerlek ø 150mm
- 2 swivel castors with brake
- 2 fixed castors ø 150mm





- ✓ Merkezi kilit
- ✓ Mandal sistemi
- ✓ Devrilme emniyet sistemi
- Central lock
- Handgrip Lock system
- Anti tilt system

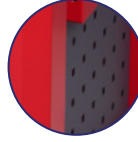

- ✓ Yüksek dayanımlı elektrostatik toz boya
- High strength electrostatic powder coating.

**Sacdan imal edilmiş, Fırın boya**  
**Made of sheet metal, Electrostatic paint**

KOD/CODE	ÇEKMECE DRAWERS	 3.5 kg	 3.5 kg	 Kg	RENK COLORS	TL/Ad
8246 32 1007	7	1098x400x60	1098x400x135	125.7		47.742,50
13000 005434 Dolu/Full 251 Parça/Pcs	7	5X	2X		<b>RAL 9005 GOF</b> <b>RAL 3020 GOF</b>	174.883,00



## 1. Grand Master Seri Çekmece/Drawer



### Sol Taraf / Left Side Kod / Code 13000 005590

KOD CODE	İÇERİK CONTENTS	☐	TL/Ad
0330	<b>Kombine Anahtar Uzun Boy</b> Combination Wrench Long Pattern 6 - 7 - 8 - 9 - 10 - 11 - 12 - 13 - 14 - 15 - 16 - 17 - 18 - 19 - 20 - 21 - 22 - 23 - 24 - 25 - 26 - 27 - 28 mm	23	7.364,25

### Sağ Taraf / Right Side Kod / Code 13000 005589

KOD CODE	İÇERİK CONTENTS	☐	TL/Ad
0330	<b>Kombine Anahtar Uzun Boy</b> Combination Wrench Long Pattern 29 - 30 - 32 - 34 - 36 - 41 mm	6	4.584,50

## 2. Grand Master Seri Çekmece/Drawer



### Sol Taraf / Left Side Kod / Code 13000 005591

KOD CODE	İÇERİK CONTENTS	☐	TL/Ad
0130	<b>İki Ağız Anahtar Uzun Boy</b> Double Ended Open Jaw Wrench Long Pattern 6x7 - 8x9 - 10x11 - 12x13 - 14x15 - 16x17 - 18x19 - 20x22 - 21x23 - 24x26 - 25x28 - 27x32 - 36x41 mm	13	3.626,50

### Sağ Taraf / Right Side Kod / Code 13000 005592

KOD CODE	İÇERİK CONTENTS	☐	TL/Ad
0430	<b>Yıldız İki Ağız Anahtar</b> Double Ended Ring Wrench 6x7 - 8x9 - 10x11 - 12x13 - 14x15 - 16x17 - 18x19 - 20x22 - 21x23 - 24x26 - 25x28 - 27x32 - 36x41 mm	13	6.000,00

**3. Grand Master Seri Çekmece/Drawer**

**Sol Taraf / Left Side**
**Kod / Code 13000 005594**

KOD CODE	İÇERİK CONTENTS	☐	TL/Ad
3301	<b>Dış Segman Pense Yaylı Düz</b> Circlip Pliers, External (Flat) 180 - 295 mm	2	
3311	<b>Dış Segman Pense Yaylı Eğri</b> Circlip Pliers, External (Bent) 170 - 275 mm	2	10.100,00
3321	<b>İç Segman Pense Yaysız Düz</b> Circlip Pliers, Internal (Flat) 180 - 310 mm	2	
3331	<b>İç Segman Pense Yaysız Eğri</b> Circlip Pliers, Internal (Bent) 170 - 290 mm	2	

**Sağ Taraf / Right Side**
**Kod / Code 13000 005593**

KOD CODE	İÇERİK CONTENTS	☐	TL/Ad
0600	<b>Kurbağacak Anahtar 12"</b> Adjustable Wrench	1	
2400	<b>Üniversal Fort Pense 240 mm</b> Waterpump Pliers Universal	1	
2500	<b>Üniversal Ayarlı Pense 250 mm</b> Universal Grip	1	
3020	<b>Kombine Pense Opak Seri 180 mm</b> Combination Pliers	1	
3220	<b>Kargaburun Düz Uçlu Opak 180 mm</b> Long Nose Pliers	1	14.650,75
3700	<b>Yan Keski Opak Seri 160 mm</b> Side Cutting Pliers	1	
3425	<b>Hortum Kelepçe Pense Sıkıştırma Tipi 235 mm / Hose Clamp Pliers</b>	1	
07415	<b>6 Sıralı Tel Fırça Ağaç Saplı</b> Hand Brush (Wooden Handle)	1	
6380	<b>Çift Zincirli Yağ Filtresi Sökeceği 60x160 mm</b> Oil Filter Wrench With Double Chain	1	
6820	<b>Tenekeci Makası 250 mm Yaylı</b> Tinman's Snip	1	





#### 4. Grand Master Seri Çekmece/Drawer



#### Sol Taraf / Left Side

Kod / Code 13000 005595

KOD CODE	İÇERİK CONTENTS	☐	TL/Ad
4903	<b>Allen Anahtar Takımı Altı Köşe Uzun Boy 12 Parça</b> Hex Key Wrench Set Long Pattern 2 - 2,5 - 3 - 3,5 - 4 - 5 - 6 - 7 - 8 - 9 - 10 - 12	12	
4903	<b>Allen Anahtar Altı Köşe Uzun Boy</b> Hex Key Wrench Long Pattern 14 - 16 - 17 - 19 mm	4	7.897,25
4920	<b>T Tipi Allen Anahtar Takımı 8 Parça</b> Hex Key Wrench T Handle Set 2,5 - 3 - 4 - 5 - 6 - 7 - 8 - 10	8	

#### Sağ Taraf / Right Side

Kod / Code 13000 005596

KOD CODE	İÇERİK CONTENTS	☐	TL/Ad
4300	<b>Opak Seri Düz Uçlu Tornavida</b> Screwdriver, Opak, Flat 3x80 - 4x80 - 4x100 - 5x125 - 6x150 mm	5	
4320	<b>Opak Seri Yıldız Uçlu Tornavida</b> Screwdriver, Opak, Phillips 4,5x80 - 6x100 mm	2	
4770	<b>Lokma Uçlu Tornavida</b> Nut Spinner 6 - 7 - 8 - 9 - 10 - 11 - 12 - 13 mm	8	7.235,25
4780	<b>Manyetik Bits Tutucu Tornavida</b> Flexiblee 6.3x120 Screwdriver, Magnetic Bit Holder (Long)	1	
4800	<b>31'li Bits Takım (Plastik Kutulu)</b> Bit Set in Plastic Case	31	
6220	<b>Spiralli Mıknatıs 1000 gr</b> Flexible Magnet Holder	1	

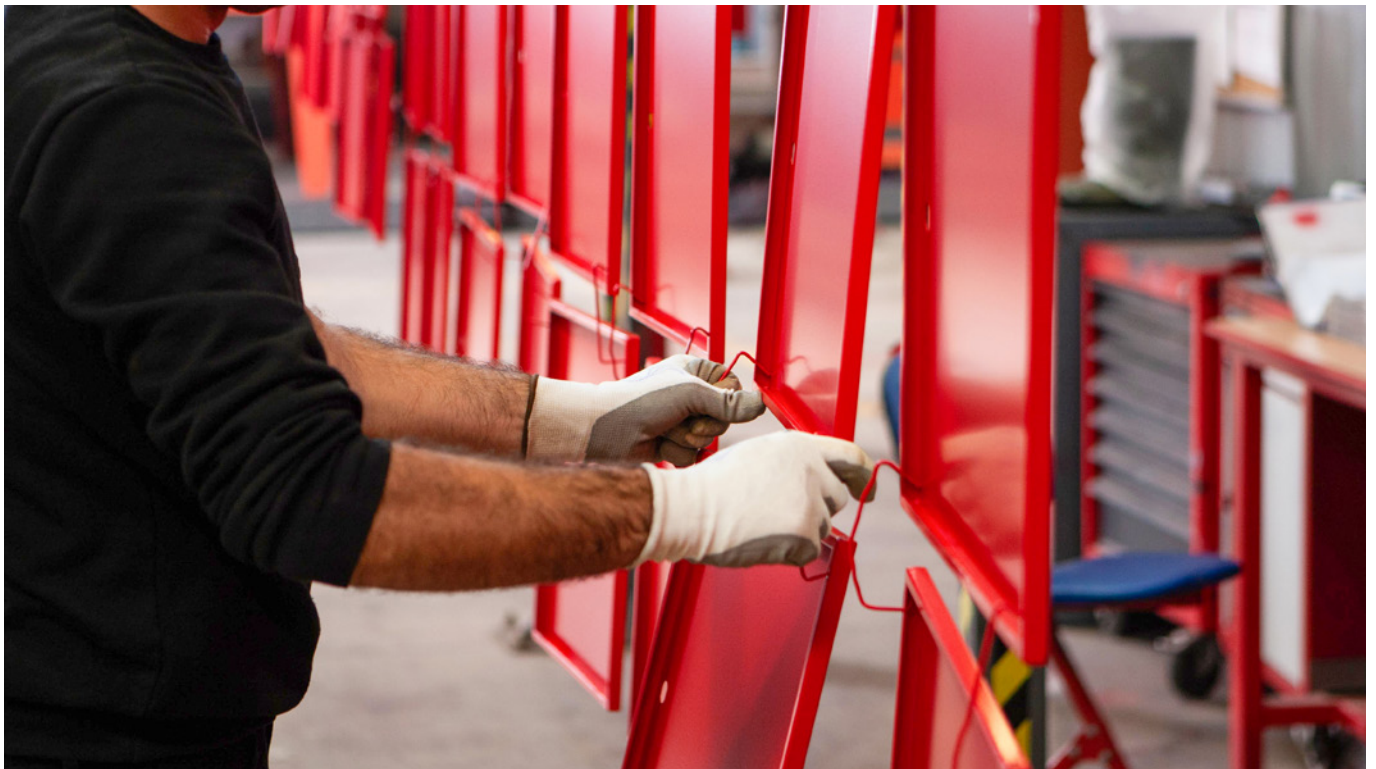

## 5. Grand Master Seri Çekmece/Drawer



Sol Taraf / Left Side

Kod / Code 13000 005598

Sağ Taraf / Right Side

Kod / Code 13000 005597

KOD CODE	İÇERİK CONTENTS	☐	TL/Ad
0340	<b>Cırcır Kombine Anahtar</b> Combination Wrench With Ratchet 10 - 13 - 17 - 19 mm	4	
1113	<b>1/2" Altı Köşe Lokma Anahtar</b> Socket Wrench 6 Points 10 - 11 - 12 - 13 - 14 - 15 - 16 - 17 - 18 - 19 - 21 - 22 - 23 - 24 - 26 - 27 - 28 - 30 - 32 mm	19	
1113	<b>1/2" Lokmalı Allen Uç</b> Hexagonal Bit Socket Wrench 5 - 6 - 7 - 8 - 10 - 12 - 14 mm	7	
1113	<b>1/2" Lokmalı Star (Torx®) Uç</b> Star Torx® Bit Socket Wrench T25 - T27 - T30 - T40 - T45 - T50 - T55 - T60	8	14.355,75
1513	<b>1/2" Cırcır Kolu 250 mm (32 Diş)</b> Ratchet Handle	1	
1513	<b>1/2" Ara Kol / Extension Bar</b> 125 - 250 mm	2	
1513	<b>1/2" T Kol 250 mm / Sliding T Handle</b>	1	
1513	<b>1/2" Mafsal 70 mm / Universal Joint</b>	1	
1513	<b>1/2" F x 3/4" M Lokma Adaptörü / Adapter</b>	1	
1519	<b>3/4" F x 1/2" M Lokma Adaptörü / Adapter</b>	1	

KOD CODE	İÇERİK CONTENTS	☐	TL/Ad
1113	<b>1/2" Altı Köşe Havalı Derin Lokma Anahtar</b> Impact Socket Wrench 6 Points 10 - 11 - 12 - 13 - 14 - 15 - 16 - 17 - 18 - 19 - 21 - 22 - 24 - 27 - 30 - 32 mm	16	
1513	<b>1/2" Fx3/4" M Havalı Lokma Adaptörü</b> Impact Socket Adapter	1	
1513	<b>1/2" Havalı Lokma Ara Kol 125 mm</b> Impact Socket Extension Bar	1	
1513	<b>1/2" Havalı Lokma Mafsal 75 mm</b> Impact Socket Universal Joint	1	
1119	<b>3/4" Altı Köşe Havalı Lokma Anahtar</b> Impact Socket Wrench 6 Points 19 - 21 - 22 - 24 - 27 - 30 - 32 - 34 - 36 - 41 - 46 mm	11	23.910,75
1519	<b>3/4" Havalı Lokma Ara Kol 250 mm</b> Impact Socket Extension Bar	1	
1519	<b>3/4" Havalı Lokma Mafsal 108 mm</b> Impact Socket Universal Joint	1	
1519	<b>3/4" F x 1/2" M Havalı Lokma Adaptörü</b> Impact Socket Adapter	1	





## 6. Grand Master Seri Çekmece/Drawer



Sol Taraf / Left Side

Kod / Code 13000 005600

Sağ Taraf / Right Side

Kod / Code 13000 005599

KOD CODE	İÇERİK CONTENTS	☐	TL/Ad
5010	Iskarpela Düz 22 mm Wood Chisel	1	
5800	Tesviyeci Çekiç Machinist Hammer 2000 - 500 gr	2	
5850	Plastik Çekiç 40 mm Plastic Hammer	1	
05881	Plastik Şerit Metre 5 m Plastic Steel Case Measuring Tapes	1	6.826,40
	Topuklu Keçe Levyesi 400 mm Prybar	1	
5500	Düz Keski 250 mm Flat Cold Chisel	1	
	Antifriz Bomesi Antifreeze tester	1	

KOD CODE	İÇERİK CONTENTS	☐	TL/Ad
1119	3/4" Altı Köşe Lokma Anahtar Socket Wrench 6 Points 22 - 24 - 27 - 30 - 32 - 34 - 36 - 41 - 46 - 50 - 55 - 60 mm	12	
1519	3/4" Cırcır Kolu 510 mm Ratchet Handle	1	
1519	3/4" Ara Kol Extension Bar 200 - 400 mm	2	18.112,00
1519	3/4" T Kol 500 mm Sliding T Handle	1	

## 7. Grand Master Seri Çekmece/Drawer

Gres Pompası / Grease Gun



Gres Pompası Hortumu / Hose for Grease Gun



Levye Oluklu Kıvrık Uçlu / Tyre Lever, Bent



KOD CODE	İÇERİK CONTENTS	☐	TL/Ad
6230	Gres Pompası (500 cc) Grease Gun	1	1.298,50
6230	Gres Pompası Hortumu Hose for Grease Gun	1	253,25
6360	Levye Oluklu Kıvrık Uçlu 600 mm Tyre Lever, Bent	2	925,25





**Premium Serisi Takım Dolabı (5-7 Çekmeceli)**

Premium Series Workshop Trolley (5-7 Drawers)



✓ 7 bölmeli sağlam ve dayanıklı ABS plastik üst malzeme tabla.  
● Resistant and solid top cover having 6 divisions

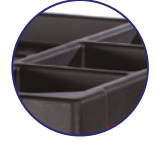

✓ %100 açılabilir teleskobik raylar.  
● %100 extendable telescopic slides



✓ Merkezi kilit  
✓ Mandal sistemi  
✓ Devrilme emniyet sistemi  
● Central lock  
● Handgrip Lock system  
● Anti tilt system



✓ 2 sabit, 2 hareketli frenli tekerlek ø 125mm  
● 2 swivel castors with brake  
2 fixed castors ø 125mm



✓ Standard tutma sapı  
● Standard handle



✓ Plastik köşe koruma  
● Plastic corner protection

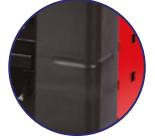

✓ Yüksek dayanımlı elektrostatik toz boya  
● High strength electrostatic powder coating

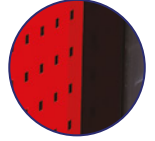

✓ Havluluk x1  
Avadanlık x2 Askılık x1  
● Paper Roll Holder  
x1 Bottle & Tins Holder x2 Hanger x1

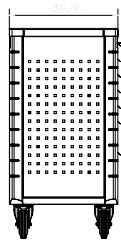
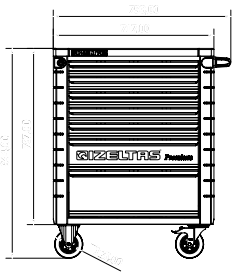
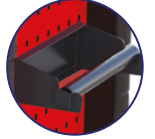





İZELTAS YOUTUBE

Ölçü/Size: 485x717x944 mm

Sacdan imal edilmiş, Fırın boya  
Made of sheet metal, Electrostatic paint

RAL 9005 GOF  
RAL 3020 GOF

KOD/CODE	ÇEKMECE DRAWERS					TL/Ad
		400x548x63	400x548x132	400x548x202		
8245 32 1005	5	2X	1X	2X	64	30.975,25
8245 32 1007	7	5X	1X	1X	70	40.099,25
8245 00 7096 Dolu/Full 250 Parça/Pcs	7	5X	1X	1X		99.327,50

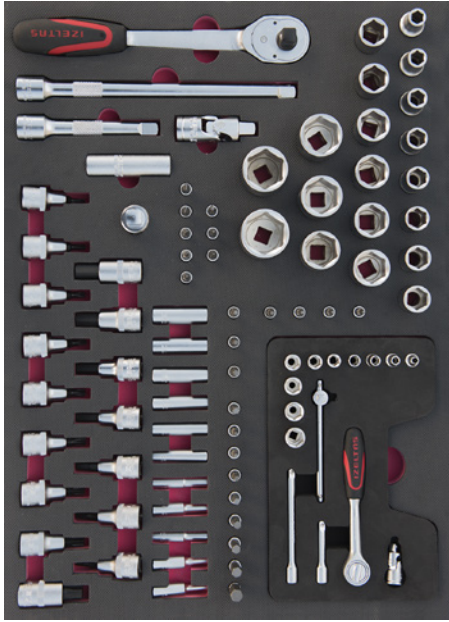

## 1. Premium Seri Çekmece/Drawer Kod / Code 8245 00 1042

KOD CODE	İÇERİK CONTENTS	☐	TL/Ad
0100	<b>İki Ağız Anahtar Kısa Boy</b> D/E Open Jaw Wrenches Short Pattern 6x7-8x9-10x11-12x13-14x15-16x17-18x19-20x22	8	
0320	<b>Kombine Anahtar Kısa Boy</b> Combination wrenches Short Pattern 6-7-8-9-10-11-12-13-14-15-16-17-18-19-20-21-22-24-27-30-32	21	13.219,75
0430	<b>Yıldız Anahtar</b> Ring Wrenches 6x7-8x9-10x11-12x13-14x15-16x17-18x19-20x22	8	
0340	<b>Cırcır Kombine Anahtar / Combination Wrench With Ratchet</b> 8-10-13-17-19	5	

## 2. Premium Seri Çekmece/Drawer Kod / Code 8245 00 2094

KOD CODE	İÇERİK CONTENTS	☐	TL/Ad
1107	<b>1/4" Lokmalı Allen Uçlar / Hexagonal Bits Socket</b> 2,5-3-4-5-6-7-8-10	8	
1107	<b>1/4" Lokmalı Torx Uç / Torx Bits Socket</b> T8-T9-T10-T15-T20-T25-T27-T30-T40	9	
1107	<b>1/4" Lokmalı Yıldız Uç / Phillips Bits Socket</b> PH1-PH2-PH3	3	
1107	<b>1/4" Lokmalı Düz Uç / Slotted Bits Socket</b> 3-4-5,5-6,5	4	
1107	<b>1/4" Altı Köşe Derin Lokma / Deep Socket Wrench 6 Point</b> 4-5-5,5-6-7-8-9-10-11-12-13	11	
1113	<b>1/2" Lokmalı Allen Uç / Hexagonal Bits Socket</b> 5-6-7-8-10-12-14	7	
1113	<b>1/2" Lokmalı Torx Uç / Torx Bits Socket</b> T20-T25-T27-T30-T40-T45-T50-T55-T60	9	
1107	<b>1/4" Altı Köşe Lokma Takımı / Socket Wrench Set</b> 1/4" Cırcır kolu / Ratchet Handle 1/4" Mafsal / Universal Joint 1/4" T Kol / Sliding T Handle	15	14.711,25
1113	<b>1/4" Ara Kol / Extension Bar 50-100 mm</b> <b>1/2" Buji Lokma Lastikli</b> Spark Plug Socket With Rubber 16 mm	1	
1113	<b>1/2" Lokma Takımı / Socket Wrench Set</b> 10 - 11 - 12 - 13 - 14 15 - 16 - 17 - 18 - 19 21 - 22 - 23 - 24 <b>1/2" Cırcır Kolu 32 Diş / Ratchet Handle</b> <b>1/2" Mafsal / Universal Joint</b> <b>1/2" T Kol Adaptör / Sliding T Handle Adapter</b> <b>1/2" Ara Kol / Extension Bar 125-250 mm</b>	24	

## 3. Premium Seri Çekmece/Drawer Kod / Code 8245 00 3014

KOD CODE	İÇERİK CONTENTS	☐	TL/Ad
3700	<b>Yan Keski Opak Seri / Side Cutting Pliers 160 mm</b>	1	
3020	<b>Kombine Pense Opak Seri / Combination Pliers 180 mm</b>	1	
3220	<b>Kargaburun Düz Uçlu Opak Seri / Nose Pliers Flat 180 mm</b>	1	
4300	<b>Opak Seri Düz Uçlu Tornavida / Screwdriver, Flat</b> 3x80-5x125-7x150	3	6.826,75
4320	<b>Opak Seri Yıldız Uçlu Tornavida / Screwdriver, Philips</b> 3x60-4.5x80-6x100-8x150	4	
3301	<b>Dış Segman Pensi Düz / Circlip Pliers, External Flat</b> 140-180mm	2	
3321	<b>İç Segman Pensi Düz / Circlip Pliers, Internal Flat</b> 140-180mm	2	





#### 4. Premium Seri Çekmece/Drawer Kod / Code 8245 00 4043

KOD CODE	İÇERİK CONTENTS	☐	TL/Ad
4770	Lokma Uçlu Tornavida / Nutspinner 6-7-8-9-10-13	6	
4910	Torx Allen Takım / Torx Key Wrench Set T9-T10-T15-T20-T25-T27-T30-T40	8	
4900	Allen Takımı 6 Köşe / Hex Key Wrench Set 2-2.5-3-3.5-4-5-6-7-8-9-10-12	12	7.819,25
4906	Yuvarlak Başlı Uzun Allen Takımı / Hex key Wrench Ballpoint Long Pattern Set 1.5-2-2.5-3-4-5-6-8-10	9	
4920	T Tipi Allen Anahtar / T Type Hex Key Wrench 2.5-3-4-5-6-7-8-10	8	



#### 5. Premium Seri Çekmece/Drawer Kod / Code 8245 00 5043

KOD CODE	İÇERİK CONTENTS	☐	TL/Ad.
4565	Oto Elektrik Kontrol Kalem / Car Voltage Tester 135mm	1	
07415	Sıralı Tel Fırça 4 Sıralı / Hand Brush 4 Raws	1	
2400	Üniversal Fort Pense / Waterpump Pliers Universal 240 mm	1	
2500	Üniversal Ayarlı Pense / Universal Grip 250 mm	1	
0600	Kurbağacık Anahtar / Adjustable Wrench 10"	1	
4780	Manyetik Bits Tutucu Tornavida / Screwdriver, Magnetic Bit Holder 6.3x120	1	
4800	31'li Bits Set (Plastik Kutulu) / Bits Set in plastic case	31	8.427,50
4110	Düz Topaç Tornavida / Screwdriver, Stubby, Flat 6.5x25	1	
4130	Yıldız Topaç Tornavida / Screwdriver, Stubby, Phillips 6x25	1	
5500	Düz Keski Krom / Flat Cold Chisel 150 mm	1	
5800	Tesviyeci Çekici / Machinist's Hammer 300-1500 gr	2	
6350	Levyeye Oluklu / Tyre Lever 500 mm	1	



#### 6. Premium Seri Çekmece/Drawer Kod / Code 8245 00 6009



KOD CODE	İÇERİK CONTENTS	☐	TL/Ad
1840	1/2" Mafsallı T Kol Swivel Handle With Sliding T 1/2"	1	
6230	Gres Pompası Grease Gun 500cc	1	
06375	Ayarlı Yağ Filtre Sökeceği Adjustable Slot Type Oil Filter Wrench	1	8.223,75
6225	Madeni Yağdanlık (Flexible Uçlu) Oiler With Flexible Spout 200cc	1	
1113	1/2" Altı Köşe Havalı Lokma Anahtar (mm) Impact Socket Wrench 6 Points (mm) 10-13-17-19-21-24	6	
1108	1/2" Altı Köşe Havalı Derin Lokma Anahtar 6 Point Impact Socket Wrench, Long Type (mm) 10-13-17-19-21-24	6	

**Pro Seri 3 Çekmeceli Dolap Üstü Dolap**  
Pro Series Workshop Trolley Top Unit With 3 Drawers

- ✓ Devrilme Emniyetli Sistem
- Handgrip Lock System and Antitilt System
- ✓ %100 Açılabilir Teleskopik Ray
- Telescopic Slides Which Are %100 extendable
- ✓ Merkezi Kilit Sistemi
- Central Lock System
- ✓ 1 Adet 9 Bölmeli Sağlam ve Dayanıklı ABS Üst Tabla
- Durable ABS Worktop With 9 Divisions
- ✓ 2 Adet Yan Avadanlık
- 2 Side Holders
- ✓ 10 Adet Çekmece Separatörü
- 10 Drawer Separators
- ✓ 1 Adet Arka Avadanlık
- 1 Back Holder

Ölçü/Size: 474x674x424 mm

Sacadan imal edilmiş, Fırın boya  
Made of sheet metal, Electrostatic paint

KOD/CODE	ÇEKMECE DRAWERS	 3.5 kg	 Kg	RENK COLORS	TL/Ad
13000 005279	3	400x548x68	29.2	RAL 7035 GOF RAL 3020 GOF	17.813,00

## 8241 PRO SERİSİ / PRO SERIES

### Pro Serisi Takım Dolabı (5-6-7-8 Çekmeceli) Pro Series Workshop Trolley (5-6-7-8 Drawers)



✓ Merkezi kilit sistemi, mandal sistemi ve devrilme emniyet sistemi  
● Central lock system, handgrip lock system and antitilt system



✓ Teleskobik rulmanlı kızaklar tüm çekmeceler %100 açılabilir  
● Telescopic slides which are %100 extendable



✓ 9 bölmeli sağlam ve dayanıklı ABS plastik üst malzeme tabla  
● 9 durable ABS worktop with divisions

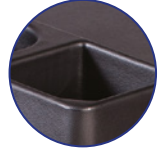

✓ 2 sabit, 2 hareketli frenli tekerlek Ø 125mm  
● 2 swivel castors with brake, 2 fixed castors Ø 125mm



✓ Yüksek dayanımlı elektrostatik toz boya  
● High strength electrostatic powder coating

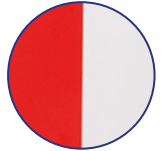

✓ Toplam 6 Adet yan ve arka avadanlık bölümleri  
● 6 tool holders

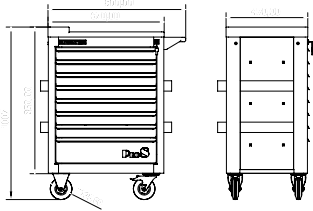

Ölçü/Size: 470x670x1007 mm





Sacdan imal edilmiş, Fırın boya  
Made of sheet metal, Electrostatic paint



RAL 7035 GOF  
RAL 3020 GOF

RAL 7035 GOF  
RAL 5003 GOF

RAL 7035 GOF  
RAL 7016 GOF

KOD/CODE	ÇEKMECE DRAWERS				 Kg	RENK COLORS	TL/Ad
8241 32 1005	5	1X	4X	--	59		32.026,75
8241 32 1006	6	4X	1X	1X	62	RAL 7035 GOF	34.607,50
8241 32 1007	7	5X	2X	--	65	RAL 3020 GOF	40.897,50
8241 32 1008	8	7X	1X	--	67		43.595,00
8241 32 2005	5	1X	4X	--	59		32.026,75
8241 32 2006	6	4X	1X	1X	62	RAL 7035 GOF	34.607,50
8241 32 2007	7	5X	2X	--	65	RAL 5003 GOF	40.897,50
8241 32 2008	8	7X	1X	--	67		43.595,00
8241 32 3005	5	1X	4X	--	59		32.026,75
8241 32 3006	6	4X	1X	1X	62	RAL 7035 GOF	34.607,50
8241 32 3007	7	5X	2X	--	65	RAL 7016 GOF	40.897,50
8241 32 3008	8	7X	1X	--	67		43.595,00
8241 00 1209 Dolu/Full 206 Parça/Pcs	8	7X	1X	--			95.060,00



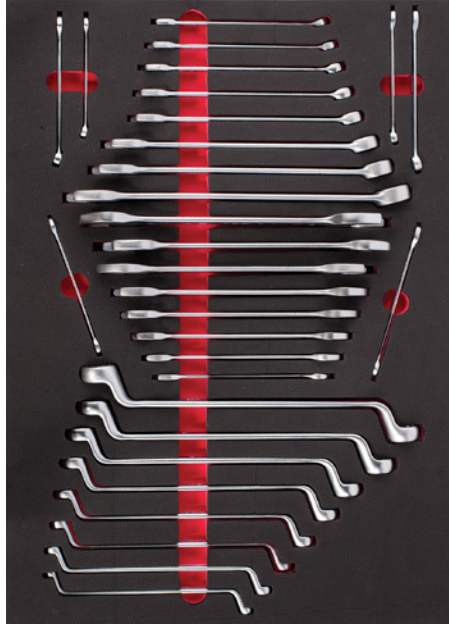

### 1. Pro Seri Çekmece/Drawer Kod / Code 8241 00 1030

KOD CODE	İÇERİK CONTENTS	TL/Ad
0130	<b>İki Ağız Anahtar Uzun Boy / D/E Open Jaw Wrench Long Pattern</b> 6x7 - 8x9 - 10x11 - 12x13 14x15 - 16x17 - 18x19 - 20x22 21x23 - 24x26	10
0330	<b>Kombine Anahtar Uzun Boy / Combination Wrench Long Pattern</b> 6 - 7 - 8 - 9 - 10 - 11 - 12 - 13 14 - 17 - 19 - 22	12 6.673,50
0430	<b>Yıldız Anahtar / D/E Ring Wrench</b> 6x7 - 8x9 - 10x11 - 12x13 14x15 - 16x17 18x19 - 20x22	8



### 2. Pro Seri Çekmece/Drawer Kod / Code 8241 00 2072

KOD CODE	İÇERİK CONTENTS	TL/Ad
1107	<b>1/4" Altı Köşe Lokma Takımı / 1/4" Socket Wrench Set</b> 4 - 5 - 6 7 - 8 - 9 - 10 11 - 12 - 13 <b>Altı Köşe</b> Six Point	15
1113	<b>1/4" Ara Kol / 1/4" Extension Bar 50-100 mm</b> <b>1/2" Lokma Takımı / 1/2" Socket Wrench Set</b> 10 - 11 - 12 13 - 14 - 15 16 - 17 - 18 19 - 21 - 22 23 - 24 - 26 27 - 28 - 30 32	13.306,00
1113	<b>1/2" Cırcır Kolu 32 Diş / 1/2" Ratchet Handle</b> <b>1/2" Mafsal / 1/2" Universal Joint</b>	24
1113	<b>1/2" T Kol Adaptör / 1/2" Sliding T Handle Adapter</b> <b>1/2" Ara Kol / 1/2" Extension Bar 125-250 mm</b>	7
1113	<b>1/2" Lokmalı Allen Uçlar / 1/2" Hexagonal Bits Sockets</b> H5-H6-H7-H8-H10-H12-H14	9
1113	<b>1/2" Lokmalı Star Uç / 1/2" Star Bits Socket</b> T20-T25-T27-T30-T40-T45-T50-T55-T60	2
0330	<b>Kombine Anahtar Uzun Boy / Combination Wrench Long 16-18</b>	2
4900	<b>Allen Takımı 6 Köşe / Hex Key Wrench Set 2-2,5-3-3,5-4-5-6-7-8-9-10-12</b>	12



### 3. Pro Seri Çekmece/Drawer Kod / Code 8241 00 3051

KOD CODE	İÇERİK CONTENTS	TL/Ad
07415	<b>Sıralı Tel Fırça 3 Sıralı / Hand Brush 3 Rows</b>	1
6350	<b>Levye Oluklu / Tyre Lever 400 mm</b>	1
6220	<b>Spiralli Miknatis / Flexible Magnet Holder 500 gr</b>	1
4110	<b>Düz Topaç Tornavida / Screwdriver , Stubby, Flat 6.5x25</b>	1
4130	<b>Yıldız Topaç Tornavida / Screwdriver , Stubby, Phillips 6x25</b>	1 6.330,00
4770	<b>Lokma Uçlu Tornavida / Nutspinner 6-7-8-9-10-13</b>	6
4780	<b>Manyetik Bits Tutucu Tornavida / Screwdriver, Magnetic Bit Holder 6.3x120</b>	1
4905	<b>Yuvarlak Başlı Allen Takımı / Hexkey Wrench Ballpoint Set</b> 2-2,5-3-4-5-6-8-10	8
4800	<b>Bits Set Takım (Plastik Kutulu) / Bits Set in Plastic Case</b>	31



#### 4. Pro Seri Çekmece/Drawer Kod / Code 8241 00 4027

KOD CODE	İÇERİK CONTENTS	☐	TL/Ad
0340	Cırcır Kombine Anahtar / Combination Wrench With Ratchet 10-13-17-19	4	
4909	T Tipi Torx Allen Anahtar / Torx Allen Key T type T9-T10-T15-T20-T25-T27-T30-T40	8	
1108	1/2" Altı Köşe Derin Lokma / 1/2" Deep Socket Wrench, six points 10-11-12-13-14-15-16-17-18-19	10	10.963,50
1113	1/2" Altı Köşe Havalı Lokma / 1/2" Impact Socket Wrench 13-17-18-19-24	5	



#### 5. Pro Seri Çekmece/Drawer Kod / Code 8241 00 5010

KOD CODE	İÇERİK CONTENTS	☐	TL/Ad
3331	İç Eğri Segman Pense / Circlip Pliers, Internal, Bent 170 mm	1	
3321	İç Düz Segman Pense / Circlip Pliers, Internal, Flat 180 mm	1	
3311	Dış Eğri Segman Pense / Circlip Pliers, External, Bent 170 mm	1	
3301	Dış Düz Segman Pense / Circlip Pliers, External, Flat 180 mm	1	
3700	Yan Keski Opak İzole / Side Cutting Pliers, 160 mm	1	9.068,50
3220	Düz Kargaburun Opak İzole / Nose Pliers, 200 mm	1	
3020	Kombine Pense Opak İzole / Combination Pliers, 180 mm	1	
2510	Ayarlı Pense / Special Grip 250 mm	1	
0600	Kurbağacık Anahtar / Adjustable Jaw Wrench 10"	1	
2400	Üniversal Fort Pense / Waterpump Pliers Universal 240 mm	1	



#### 6. Pro Seri Çekmece/Drawer Kod / Code 8241 00 6018

KOD CODE	İÇERİK CONTENTS	☐	TL/Ad
4300	Opak Seri Düz Uçlu Tornavida / Opak Screwdriver, Flat 4x100-5x125-6x150-8x175	4	
4320	Opak Seri Yıldız Uçlu Tornavida / Opak Screwdriver, Phillips 4.5x80-6x100	2	
5800	Tesviyeci Çekiç / Mechanist Hammer 300 gr	1	
5850	Plastik Çekiç / Plastic Hammer ø30	1	5.123,50
5545	Konik Pim Zimba / Drift Punch 5 mm	1	
5550	Düz Pim Zimba / Split Pin Punch 5 mm	1	
5540	Nokta Zimba / Center Punch 5x120	1	
5500	Düz Keski / Flat Cold Chisel 150 mm	1	
4920	T Tipi Allen Anahtar / T Type Hex Key Wrench 3-4-5-6-7-8	6	



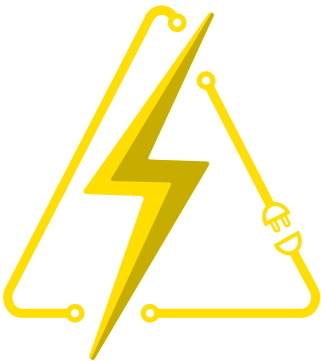

**ELEKTRO**



## ELEKTRO SERİSİ / ELECTRO SERIES

### Elektro Serisi Takım Dolabı (7 Çekmeceli) Electro Series Workshop Trolley (7 Drawers)

**YENİ  
NEW**

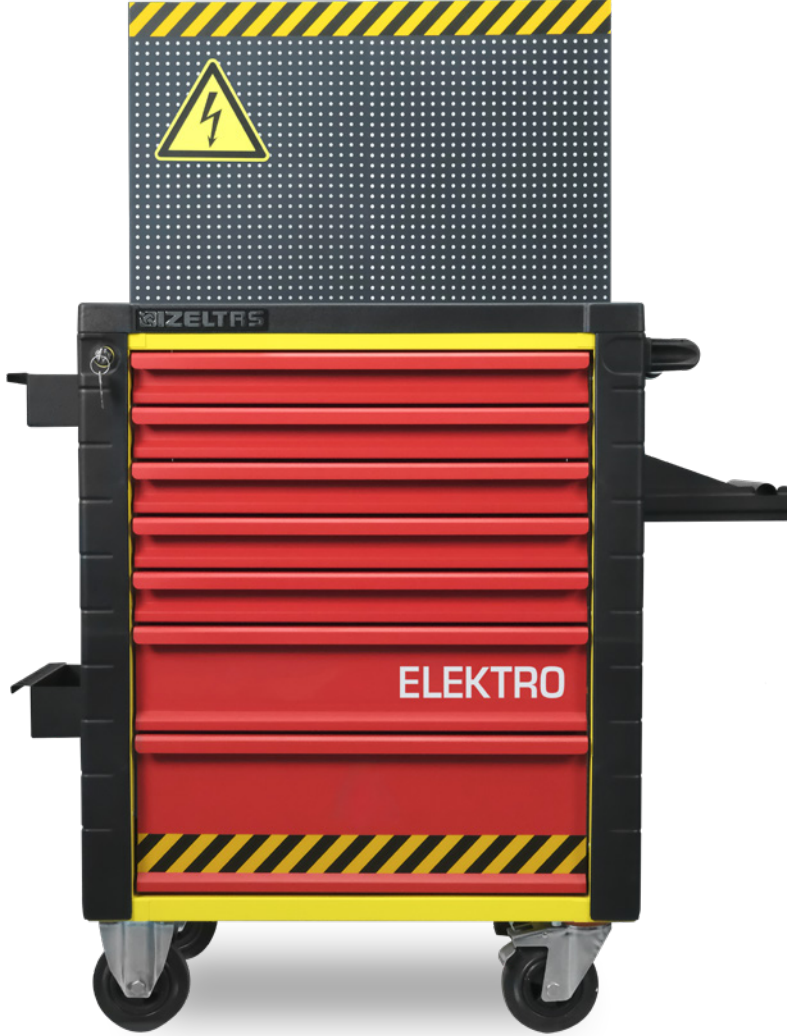

✓ 7 bölmeli sağlam ve dayanıklı  
ABS plastik üst malzeme tabla  
● Resistant and solid top  
cover having 7 divisions

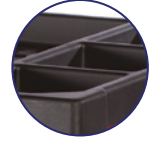

✓ %100 açılabilir  
teleskobik raylar  
● %100 extendable  
telescopic slides



✓ Merkezli kilit  
✓ Mandal sistemi  
✓ Devrilme emniyet sistemi  
● Central lock  
● Handgrip Lock system  
● Anti tilt system



✓ 2 sabit, 2 hareketli  
frenli tekerlek ø 125mm  
● 2 swivel castors with brake  
2 fixed castors ø 125mm



✓ Standard tutma sapı  
● Standard handle



✓ Plastik köşe koruma  
● Plastic corner  
protection



✓ Yüksek dayanımlı  
elektrostatik gofrato toz boya  
● High strength electrostatic  
gofrato powder coating

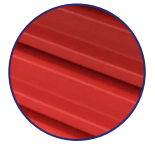

✓ Havluluk x1  
Avadanlık x2 Askılık x1  
● Paper Roll Holder  
x1 Bottle & Tins  
Holder x2 Hanger x1



✓ Magnet Uyarı Etiketi  
● Magnet Warning Sticker



✓ Delikli Sac Pano ve  
20 Adet Askı Teli  
● Perforated Panel for  
Hand Tools

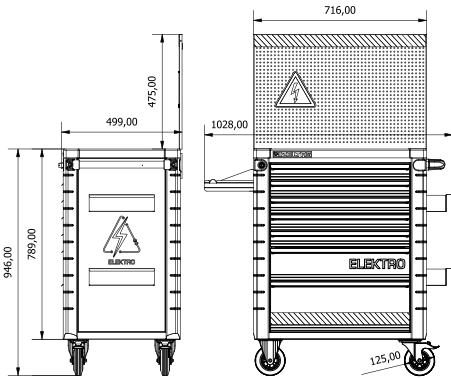





Ölçü/Size: 500x715x945 mm

Sacdan imal edilmiş, Fırın boya  
Made of sheet metal, Electrostatic paint

RAL 9005 GOF

RAL 3020 GOF

RAL 1016

KOD/CODE	ÇEKMECE DRAWERS				 Kg	TL/Ad
13000 005547	7	400x548x63	400x548x132	400x548x202		42.827,50
13000 005548 Dolu/Full 93 Parça/Pcs	7	5X	1X	1X		91.431,50



## 1. Elektro Seri Çekmece/Drawer Kod / Code 13000 005568

KOD CODE	İÇERİK CONTENTS	☐	TL/Ad.
0255 01 0010	Süper İzole Çatal Bir Ağız Anahtar 10 mm / Single Ended Open Jaw Wrench Super Insulated	1	9.681,75
0255 01 0011	Süper İzole Çatal Bir Ağız Anahtar 11 mm / Single Ended Open Jaw Wrench Super Insulated	1	
0255 01 0012	Süper İzole Çatal Bir Ağız Anahtar 12 mm / Single Ended Open Jaw Wrench Super Insulated	1	
0255 01 0013	Süper İzole Çatal Bir Ağız Anahtar 13 mm / Single Ended Open Jaw Wrench Super Insulated	1	
0255 01 0014	Süper İzole Çatal Bir Ağız Anahtar 14 mm / Single Ended Open Jaw Wrench Super Insulated	1	
0255 01 0017	Süper İzole Çatal Bir Ağız Anahtar 17 mm / Single Ended Open Jaw Wrench Super Insulated	1	
0255 01 0019	Süper İzole Çatal Bir Ağız Anahtar 19 mm / Single Ended Open Jaw Wrench Super Insulated	1	
0255 01 0022	Süper İzole Çatal Bir Ağız Anahtar 22 mm / Single Ended Open Jaw Wrench Super Insulated	1	
0255 01 0024	Süper İzole Çatal Bir Ağız Anahtar 24 mm / Single Ended Open Jaw Wrench Super Insulated	1	
0435 03 0010	Süper İzoleli Bir Ağız Yıldız Anahtar 10 mm / Single Ended Ring Wrench Super Insulated	1	
0435 03 0011	Süper İzoleli Bir Ağız Yıldız Anahtar 11 mm / Single Ended Ring Wrench Super Insulated	1	
0435 03 0012	Süper İzoleli Bir Ağız Yıldız Anahtar 12 mm / Single Ended Ring Wrench Super Insulated	1	
0435 03 0013	Süper İzoleli Bir Ağız Yıldız Anahtar 13 mm / Single Ended Ring Wrench Super Insulated	1	
0435 03 0014	Süper İzoleli Bir Ağız Yıldız Anahtar 14 mm / Single Ended Ring Wrench Super Insulated	1	
0435 03 0017	Süper İzoleli Bir Ağız Yıldız Anahtar 17 mm / Single Ended Ring Wrench Super Insulated	1	
0435 03 0019	Süper İzoleli Bir Ağız Yıldız Anahtar 19 mm / Single Ended Ring Wrench Super Insulated	1	
0435 03 0022	Süper İzoleli Bir Ağız Yıldız Anahtar 22 mm / Single Ended Ring Wrench Super Insulated	1	
0435 03 0024	Süper İzoleli Bir Ağız Yıldız Anahtar 24 mm / Single Ended Ring Wrench Super Insulated	1	



## 2. Elektro Seri Çekmece/Drawer Kod / Code 13000 005569

KOD/CODE	İÇERİK CONTENTS	☐	TL/Ad.
13000 005148	1000V 1/2" Altı Köşe Lokma Anahtar 10 mm / Socket Wrech 6 Points	1	20.602,00
13000 005149	1000V 1/2" Altı Köşe Lokma Anahtar 11 mm / Socket Wrech 6 Points	1	
13000 005150	1000V 1/2" Altı Köşe Lokma Anahtar 12 mm / Socket Wrech 6 Points	1	
13000 005151	1000V 1/2" Altı Köşe Lokma Anahtar 13 mm / Socket Wrech 6 Points	1	
13000 005152	1000V 1/2" Altı Köşe Lokma Anahtar 14 mm / Socket Wrech 6 Points	1	
13000 005153	1000V 1/2" Altı Köşe Lokma Anahtar 15 mm / Socket Wrech 6 Points	1	
13000 005154	1000V 1/2" Altı Köşe Lokma Anahtar 16 mm / Socket Wrech 6 Points	1	
13000 005155	1000V 1/2" Altı Köşe Lokma Anahtar 17 mm / Socket Wrech 6 Points	1	
13000 005156	1000V 1/2" Altı Köşe Lokma Anahtar 19 mm / Socket Wrech 6 Points	1	
13000 005157	1000V 1/2" Altı Köşe Lokma Anahtar 22 mm / Socket Wrech 6 Points	1	
13000 005158	1000V 1/2" Altı Köşe Lokma Anahtar 24 mm / Socket Wrech 6 Points	1	
13000 005159	1000V 1/2" Altı Köşe Lokma Anahtar 27 mm / Socket Wrech 6 Points	1	
13000 005277	1000V 1/2" Cırcır Kol 36 Diş / Ratchet Handle	1	
13000 005262	1000V 1/2" Ara Kol 75 mm / Extension Bar	1	
13000 005264	1000V 1/2" Ara Kol 250 mm / Extension Bar	1	
13000 005541	1000V 1/2" İzoleli T Kol / Sliding T-Handle	1	



### 3. Elektro Seri Çekmece/Drawer

Kod / Code 13000 005570

KOD/CODE	İÇERİK CONTENTS	☐	TL/Ad.
2400 11 6240	1000V İzoleli Üniversal Fort Pense 240 mm Insulated Type Waterpump Pliers Universal	1	8.438,00
3020 12 6160	1000V İzoleli Elektrikçi Kombine Pense 160 mm Insulated Electrician Type Combination Pliers	1	
3220 13 6180	1000V İzoleli Elektrikçi Düz Kargaburun 180 mm Insulated Electrician Type Nose Pliers	1	
3700 16 6160	1000V İzoleli Elektrikçi Yan Keski 160 mm Insulated Electrician Type Side Cutter	1	
3715 16 6165	1000V İzoleli Tek Ağızlı Kablo Kesici 165 mm Insulated Cable Cutter	1	
0600 01 0010	1000V İzoleli Kurbağacık Anahtar 10" Insulated Electrician Type Adjustable Wrench	1	
03753 50 026	Elektro Mekanik Kablo Sıyrıcı 0.2-6mm Insulated Mechanical Cable Stripper	1	



### 4. Elektro Seri Çekmece/Drawer

Kod / Code 13000 005571

KOD CODE	İÇERİK CONTENTS	☐	TL/Ad.
4140 17 2575	1000V İzoleli Elektrikçi Düz Uç Tornavida 2.5x75 / Insulated Electrician Type Flat Screwdriver	1	9.882,25
4140 17 4100	1000V İzoleli Elektrikçi Düz Uç Tornavida 4x100 / Insulated Electrician Type Flat Screwdriver	1	
4140 17 5512	1000V İzoleli Elektrikçi Düz Uç Tornavida 5.5x125 / Insulated Electrician Type Flat Screwdriver	1	
4140 17 6515	1000V İzoleli Elektrikçi Düz Uç Tornavida 6.5x150 / Insulated Electrician Type Flat Screwdriver	1	
4145 18 0360	1000V İzoleli Elektrikçi Yıldız Uç Tornavida 3x60 / Insulated Electrician Type Phillips Screwdriver	1	
4145 18 4580	1000V İzoleli Elektrikçi Yıldız Uç Tornavida 4.5x80 / Insulated Electrician Type Phillips Screwdriver	1	
4145 18 6100	1000V İzoleli Elektrikçi Yıldız Uç Tornavida 6x100 / Insulated Electrician Type Phillips Screwdriver	1	
4773 19 0040	1000V Süngüsü İzoleli Lokma Uçlu Tornavida 4mm / Insulated Electrician Type Nut Spinner	1	
4773 19 0050	1000V Süngüsü İzoleli Lokma Uçlu Tornavida 5 mm / Insulated Electrician Type Nut Spinner	1	
4773 19 0055	1000V Süngüsü İzoleli Lokma Uçlu Tornavida 5.5 mm / Insulated Electrician Type Nut Spinner	1	
4773 19 0060	1000V Süngüsü İzoleli Lokma Uçlu Tornavida 6 mm / Insulated Electrician Type Nut Spinner	1	
4773 19 0070	1000V Süngüsü İzoleli Lokma Uçlu Tornavida 7 mm / Insulated Electrician Type Nut Spinner	1	
4773 19 0080	1000V Süngüsü İzoleli Lokma Uçlu Tornavida 8 mm / Insulated Electrician Type Nut Spinner	1	
4773 19 0090	1000V Süngüsü İzoleli Lokma Uçlu Tornavida 9 mm / Insulated Electrician Type Nut Spinner	1	
4773 19 0100	1000V Süngüsü İzoleli Lokma Uçlu Tornavida 10 mm / Insulated Electrician Type Nut Spinner	1	
4773 19 0110	1000V Süngüsü İzoleli Lokma Uçlu Tornavida 11 mm / Insulated Electrician Type Nut Spinner	1	
4773 19 0120	1000V Süngüsü İzoleli Lokma Uçlu Tornavida 12 mm / Insulated Electrician Type Nut Spinner	1	
4773 19 0130	1000V Süngüsü İzoleli Lokma Uçlu Tornavida 13 mm / Insulated Electrician Type Nut Spinner	1	
4773 19 0140	1000V Süngüsü İzoleli Lokma Uçlu Tornavida 14 mm / Insulated Electrician Type Nut Spinner	1	
4783 19 6120	1000V Süngüsü İzoleli Manyetik Bits Tutucu Tornavida 6.3x120 / Insulated Magnetic Bit Holder	1	
4800 00 8131	31li Bits Takım (Plastik Kutulu) / Bit Set in Plastic Case	31	





Garaj Serisi Takım Dolabı (5-6-7-8 Çekmeceli)  
 Garage Series Workshop Trolley (5-6-7-8 Drawers)

- ✓ Ergonomik sap
- Ergonomic handle

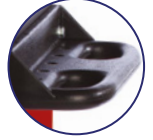

- ✓ 9 Bölmeli, sağlam ABS tabla
- 9 durable ABS worktop with divisions



- ✓ Havluluk x1
- Avadanlık x2
- Askılık x1
- Paper Roll Holder
- x1 Bottle & Tins Holder
- x2 Hanger x1



- ✓ %100 açılabilir teleskobik raylar
- %100 extendable telescopic slides



- ✓ Merkezi kilit sistemi, mandal sistemi devrilme emniyet sistemi
- Central locking, system handgrip lock system antitilt system



- ✓ 2 sabit, 2 hareketli frenli tekerlek Ø 125mm
- 2 swivel castors with brake
- 2 fixed castors Ø 125 mm



- ✓ Yüksek dayanımlı elektostatik toz boya
- High strength electrostatic powder coating



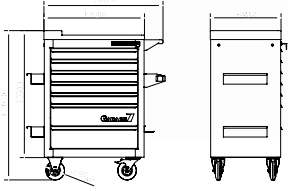

Ölçü/Size: 470x670x1010 mm

 Sacdan imal edilmiş, Fırın boya  
 Made of sheet metal, Electrostatic paint

 RAL 9005 GOF  
 RAL 3020 GOF

 RAL 9005 GOF  
 RAL 5003 GOF

 RAL 9005 GOF  
 RAL 7035 GOF

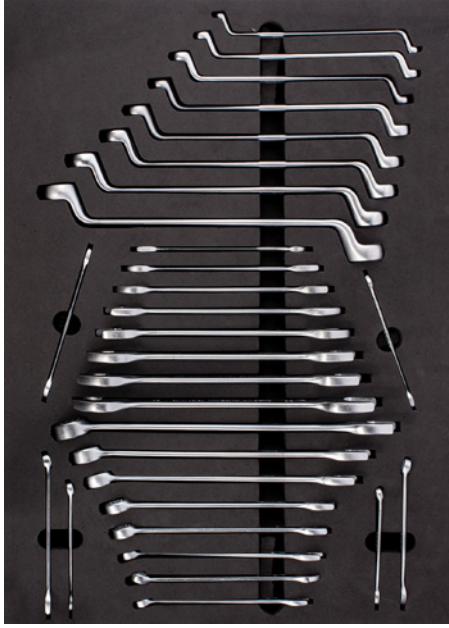
KOD/CODE	ÇEKMECE DRAWERS				Kg	RENK COLORS	TL/Ad
★ 8242 32 1005	5	1X	4X	--	59		28.617,25
★ 8242 32 1006	6	4X	1X	1X	62	RAL 9005 GOF	33.683,75
★ 8242 32 1007	7	5X	2X	--	65	RAL 3020 GOF	39.355,25
★ 8242 32 1008	8	7X	1X	--	67		43.203,75
★ 8242 32 2005	5	1X	4X	--	59		28.617,25
★ 8242 32 2006	6	4X	1X	1X	62	RAL 9005 GOF	33.683,75
★ 8242 32 2007	7	5X	2X	--	65	RAL 5003 GOF	39.355,25
★ 8242 32 2008	8	7X	1X	--	67		43.203,75
★ 8242 32 3005	5	1X	4X	--	59		28.617,25
★ 8242 32 3006	6	4X	1X	1X	62	RAL 9005 GOF	33.683,75
★ 8242 32 3007	7	5X	2X	--	65	RAL 7035 GOF	39.355,25
★ 8242 32 3008	8	7X	1X	--	67		43.203,75
★ 8242 00 1142 Dolu/Full 139 Parça/Pcs	7	5X	2X	--			77.583,25
★ 8242 00 8142 Dolu/Full 139 Parça/Pcs	8	7X	1X	--			81.431,75



## 1. Garaj Seri Çekmece/Drawer

Kod / Code 8242 00 1030

KOD CODE	İÇERİK CONTENTS	☐	TL/Ad
0130	<b>İki Ağız Anahtar Uzun Boy</b> D/E Open Jaw Wrench Long Pattern 6x7 - 8x9 - 10x11 - 12x13 14x15 - 16x17 - 18x19 - 20x22 - 21x23 - 24x26	10	
0330	<b>Kombine Anahtar Uzun Boy</b> Combination Wrenches Long Pattern 6 - 7 - 8 - 9 - 10 - 11 - 12 - 13 - 14 - 17 - 19 - 22	12	6.673,50
0430	<b>Yıldız Anahtar</b> Ring Wrench 6x7 - 8x9 - 10x11 - 12x13 - 14x15 - 16x17 - 18x19 - 20x22	8	

## 2. Garaj Seri Çekmece/Drawer

Kod / Code 8242 00 2072



KOD CODE	İÇERİK CONTENTS	☐	TL/Ad
1113	<b>1/2" Lokmalı Allen Uçlar</b> Hexagonal Bits Socket H5-H6-H7-H8-H10-H12-H14	7	
1113	<b>1/2" Lokmalı Star Uç / 1/2 Star Bits Socket</b> T20-T25-T27-T30-T40-T45-T50-T55-T60	9	
0330	<b>Kombine Anahtar Uzun Boy</b> Combination Pliers Long 16-18	2	
4900	<b>Allen Takımı Altı Köşe / Hex Key Wrench Set</b> 2-2.5-3-3.5-4-5-6-7-8-9-10-12	12	
1107	<b>1/4" Altı Köşe Lokma Takımı</b> Socket Wrench Set 4 - 5 - 6 7 - 8 - 9 - 10 11 - 12 - 13 <b>Altı Köşe</b> Six Points	15	13.306,00
	<b>1/4" Cırcır Kolu</b> Ratchet Handle		
	<b>1/4" Mafsal</b> Universal Joint		
	<b>1/4" T Kol / Sliding T Handle</b>		
	<b>1/4" Ara Kol / Extension Bar 50 -100 mm</b>		
	<b>1/2" Lokma Takımı</b> Socket Wrench Set		
1113	<b>1/2" Cırcır Kolu 32 Diş</b> Ratchet Handle		
	<b>1/2" Mafsal</b> Universal Joint		
	<b>1/2" T Kol Adaptör</b> Sliding T Handle Adapter		
	<b>1/2" Ara Kol</b> Extension Bar 125-250 mm		

★ Stoklarla Sınırlıdır / It is Limited by Stocks.





### 3. Garaj Seri Çekmece/Drawer

Kod / Code 8242 00 3010

KOD CODE	İÇERİK CONTENTS		TL/Ad
3331	<b>İç Eğri Segman Pense</b> Circlip Pliers Internal (Bent) 170 mm	1	
3321	<b>İç Düz Segman Pense</b> Circlip Pliers Internal (Flat) 180 mm	1	
3311	<b>Dış Eğri Segman Pense</b> Circlip Pliers External (Bent) 170 mm	1	
3301	<b>Dış Düz Segman Pense</b> Circlip Pliers External (Flat) 180 mm	1	
3700	<b>Yan Keski Opak Seri</b> Side Cutting Pliers 160 mm	1	9.068,50
3220	<b>Düz Kargaburun Opak Seri</b> Nose Pliers (Flat) 200 mm	1	
3020	<b>Kombine Pense Opak Seri</b> Combination Pliers 180 mm	1	
2510	<b>Ayarlı Pense / Special</b> 250 mm	1	
0600	<b>Kurbağacık Anahtar / Adjustable Wrench</b> 10"	1	
2400	<b>Üniversal Fort Pense / Waterpump Pliers</b> Universal 240 mm	1	



### 4. Garaj Seri Çekmece/Drawer

Kod / Code 8242 00 4018

KOD CODE	İÇERİK CONTENTS		TL/Ad
4300	<b>Opak Seri Düz Uçlu Tornavida</b> Screwdriver, Opak Flat 4x100-5x125-6x150-8x175	4	
4320	<b>Opak Seri Yıldız Uçlu Tornavida</b> Screwdriver, Opak Philips 4.5x80-6x100	2	
5800	<b>Tesviyeci Çekiç</b> Machinist's Hammer 300 gr	1	
5850	<b>Plastik Çekiç</b> Plastic Hammer ø30	1	5.123,50
5545	<b>Konik Pim Zimba</b> Drift Punch 5 mm	1	
5550	<b>Düz Pim Zimba</b> Split Pin Punch 5 mm	1	
5540	<b>Nokta Zimba</b> Center Punch 5x120	1	
5500	<b>Düz Keski</b> Flat Cold Chisel 150 mm	1	
4920	<b>T Tipi Allen Anahtar / Hex Key Wrench</b> 3-4-5-6-7-8	6	

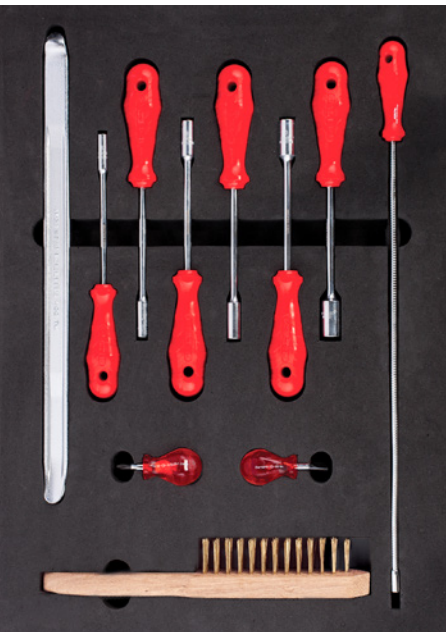

### 5. Garaj Seri Çekmece/Drawer

Kod / Code 8242 00 5011

KOD CODE	İÇERİK CONTENTS		TL/Ad
07415	<b>Sıralı Tel Fırça 3 Sıralı</b> Hand Brush 3 Raws	1	
6350	<b>Levye Oluklu</b> Tyre Lever, Straight 400 mm	1	
6220	<b>Spiralli Miknatis</b> Flexible Magnet Holder 500 gr	1	
4110	<b>Düz Topaç Tornavida</b> Screwdriver Stubby Flat 6.5x25	1	4.056,50
4130	<b>Yıldız Topaç Tornavida</b> Screwdriver Stubby Phillips 6x25	1	
4770	<b>Lokma Uçlu Tornavida</b> Nut Spinner 6-7-8-9-10-13	6	

★ Stoklarla Sınırlıdır / It is Limited by Stocks.



## ELITE SERİSİ / ELITE SERIES

### Elite Serisi Takım Dolabı (7 Çekmeceli) Elite Series Workshop Trolley (7 Drawers)

**YENİ  
NEW**



- ✓ Ergonomik sap
- Ergonomic handle



- ✓ 9 Bölmeli, sağlam ABS tabla
- 9 durable ABS worktop with divisions



- ✓ Havluluk x1
- Avadanlık x2
- Askılık x1
- Paper Roll Holder x1
- Bottle & Tins Holder x2
- Hanger x1

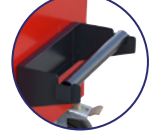

- ✓ %100 açılabilir teleskopik raylar
- %100 extendable telescopic slides



- ✓ Merkezi kilit sistemi, mandal sistemi devrilme emniyet sistemi
- Central locking system handgrip lock system antitilt system



- ✓ 2 sabit, 2 hareketli frenli tekerlek Ø 125mm
- 2 swivel castors with brake 2 fixed castors Ø 125 mm



- ✓ Yüksek dayanımlı elektrostatik toz boya
- High strength electrostatic powder coating





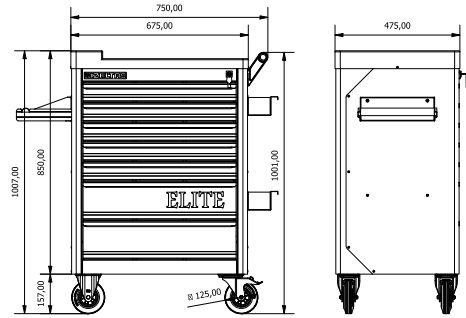

- ✓ Devrilme Emniyet Sistemli %100 Açılabilir Teleskopik Rulmanlı Ray
- 100% Extendable Telescopic Ball Bearing Rail with Tipping Safety System
- ✓ Merkezi Kilit Mandal Sistemi
- Central Lock System And Handgrip Lock System
- ✓ 1 Adet 4 Bölmeli Sağlam ve Dayanıklı ABS Üst Tabla
- 1 Piece 4 Compartment Sturdy and Durable ABS Top Table
- ✓ 2 Adet Avadanlık
- 2 Pieces of Handyman
- ✓ 1 Adet Havluluk
- 1 Piece Towel Holder
- ✓ 1 Adet Alüminyum Tutma Sapı
- 1 Piece Aluminum Handle
- ✓ 2 Sabit, 2 Hareketli, Frenli Tekerlek ø125 mm
- 2 Fixed, 2 Movable Castors with Brake ø125 mm



Ölçü/Size: 475x675x1007 mm

Sacdan imal edilmiş, Fırın boya  
Made of sheet metal, Electrostatic paint

KOD/CODE	ÇEKMECE DRAWERS					RENK COLORS	TL/Ad
13000 005563	7	400x548x68	400x548x143	400x548x218	61	RAL 9005 G0F	31.896,50
13000 005572	7	400x548x68	400x548x143	400x548x218	-	RAL 3020 G0F	70.124,50
Dolu/Full 139 Parça/Pcs							



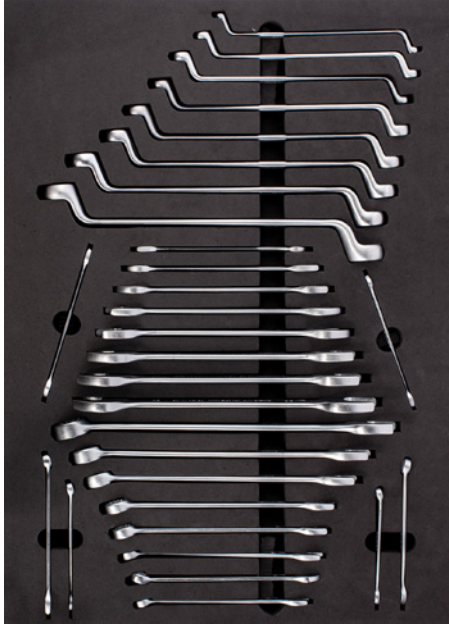

## 1. Elite Seri Çekmece/Drawer

Kod / Code 13000 005573

KOD CODE	İÇERİK CONTENTS	☐	TL/Ad
0130	<b>İki Ağız Anahtar Uzun Boy</b> D/E Open Jaw Wrench Long Pattern 6x7 - 8x9 - 10x11 - 12x13 14x15 - 16x17 - 18x19 - 20x22 - 21x23 - 24x26	10	
0330	<b>Kombine Anahtar Uzun Boy</b> Combination Wrenches Long Pattern 6 - 7 - 8 - 9 - 10 - 11 - 12 - 13 - 14 - 17 - 19 - 22	12	6.673,50
0430	<b>Yıldız Anahtar</b> Ring Wrench 6x7 - 8x9 - 10x11 - 12x13 - 14x15 - 16x17 - 18x19 - 20x22	8	

## 2. Elite Seri Çekmece/Drawer

Kod / Code 13000 005574



KOD CODE	İÇERİK CONTENTS	☐	TL/Ad
1113	<b>1/2" Lokmalı Allen Uçlar</b> Hexagonal Bits Socket H5-H6-H7-H8-H10-H12-H14	7	
1113	<b>1/2" Lokmalı Star Uç / 1/2 Star Bits Socket</b> T20-T25-T27-T30-T40-T45-T50-T55-T60	9	
0330	<b>Kombine Anahtar Uzun Boy</b> Combination Pliers Long 16-18	2	
4900	<b>Allen Takımı Altı Köşe / Hex Key Wrench Set</b> 2-2.5-3-3.5-4-5-6-7-8-9-10-12	12	
1107	<b>1/4" Altı Köşe Lokma Takımı</b> Socket Wrench Set 4 - 5 - 6 7 - 8 - 9 - 10 11 - 12 - 13 <b>Altı Köşe</b> Six Points <b>1/4" Cırcır Kolu</b> Ratchet Handle <b>1/4" Mafsal</b> Universal Joint <b>1/4" T Kol / Sliding T Handle</b> <b>1/4" Ara Kol / Extension Bar 50 -100 mm</b>	15	13.306,00
1113	<b>1/2" Lokma Takımı</b> Socket Wrench Set 10 - 11 - 12 13 - 14 - 15 16 - 17 - 18 19 - 21 - 22 23 - 24 - 26 27 - 28 - 30 32 <b>Altı Köşe</b> Six Points <b>1/2" Cırcır Kolu 32 Diş</b> Ratchet Handle <b>1/2" Mafsal</b> Universal Joint <b>1/2" T Kol Adaptör</b> Sliding T Handle Adapter <b>1/2" Ara Kol</b> Extension Bar 125-250 mm	24	



### 3. Elite Seri Çekmece/Drawer

Kod / Code 13000 005575

KOD CODE	İÇERİK CONTENTS		TL/Ad
3331	<b>İç Eğri Segman Pense</b> Circlip Pliers Internal (Bent) 170 mm	1	
3321	<b>İç Düz Segman Pense</b> Circlip Pliers Internal (Flat) 180 mm	1	
3311	<b>Dış Eğri Segman Pense</b> Circlip Pliers External (Bent) 170 mm	1	
3301	<b>Dış Düz Segman Pense</b> Circlip Pliers External (Flat) 180 mm	1	
3700	<b>Yan Keski Opak Seri</b> Side Cutting Pliers 160 mm	1	9.068,50
3220	<b>Düz Kargaburun Opak Seri</b> Nose Pliers (Flat) 200 mm	1	
3020	<b>Kombine Pense Opak Seri</b> Combination Pliers 180 mm	1	
2510	<b>Ayarlı Pense / Special Grip</b> 250 mm	1	
0600	<b>Kurbağacık Anahtar / Adjustable Wrench</b> 10"	1	
2400	<b>Üniversal Fort Pense / Waterpump Pliers</b> Universal 240 mm	1	



### 4. Elite Seri Çekmece/Drawer

Kod / Code 13000 005576

KOD CODE	İÇERİK CONTENTS		TL/Ad
4300	<b>Opak Seri Düz Uçlu Tornavida</b> Screwdriver, Opak Flat 4x100-5x125-6x150-8x175	4	
4320	<b>Opak Seri Yıldız Uçlu Tornavida</b> Screwdriver, Opak Phillips 4.5x80-6x100	2	
5800	<b>Tesviyeci Çekiç</b> Machinist's Hammer 300 gr	1	
5850	<b>Plastik Çekiç</b> Plastic Hammer ø30	1	5.123,50
5545	<b>Konik Pim Zimba</b> Drift Punch 5 mm	1	
5550	<b>Düz Pim Zimba</b> Split Pin Punch 5 mm	1	
5540	<b>Nokta Zimba</b> Center Punch 5x120	1	
5500	<b>Düz Keski</b> Flat Cold Chisel 150 mm	1	
4920	<b>T Tipi Allen Anahtar / Hex Key Wrench</b> 3-4-5-6-7-8	6	

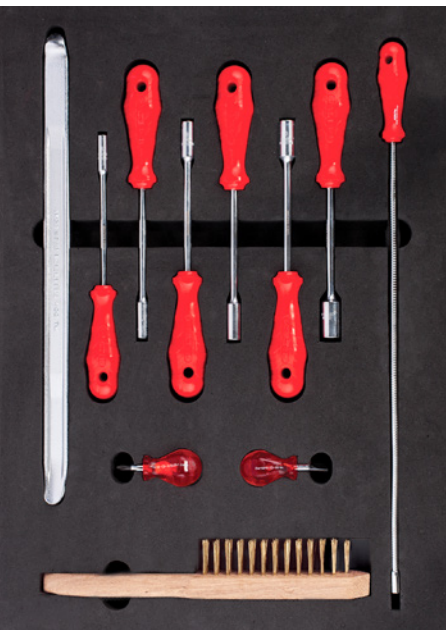

### 5. Elite Seri Çekmece/Drawer

Kod / Code 13000 005577

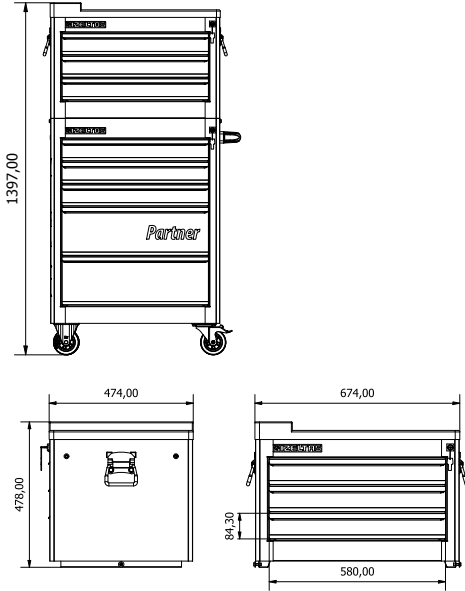

KOD CODE	İÇERİK CONTENTS		TL/Ad
07415	<b>Sıralı Tel Fırça 3 Sıralı</b> Hand Brush 3 Raws	1	
6350	<b>Levyeye Oluklu</b> Tyre Lever, Straight 400 mm	1	
6220	<b>Spiralli Miknatis</b> Flexible Magnet Holder 500 gr	1	
4110	<b>Düz Topaç Tornavida</b> Screwdriver Stubby Flat 6.5x25	1	4.056,50
4130	<b>Yıldız Topaç Tornavida</b> Screwdriver Stubby Phillips 6x25	1	
4770	<b>Lokma Uçlu Tornavida</b> Nut Spinner 6-7-8-9-10-13	6	

**Partner Seri 3 Çekmeceli Dolap Üstü Dolap**  
Partner Series Workshop Trolley Top Unit With 3 Drawers

- ✓ Standart Tırnaklı %100 Açılabilir Teleskopik Ray
- Telescopic Slides Which Are %100 Extendable
- ✓ Merkezi Kilit Mandal Sistemi
- Central Lock System And Handgrip Lock System
- ✓ 1 Adet 9 Bölümlü Sağlam ve Dayanıklı ABS Üst Tabla
- Durable ABS Worktop With 9 Divisions

Ölçü/Size: 474x674x478 mm

Sacdan imal edilmiş, Fırın boya  
Made of sheet metal, Electrostatic paint

KOD/CODE	ÇEKMECE DRAWERS	 3.5 kg	 Kg	RENK COLORS	TL/Ad
13000 005561	3	400x548x74	32.40	RAL 3020 GOF	17.280,50



Partner Mobil Takım Dolabı (5 Çekmeceli)  
Partner Workshop Trolley (5 Drawers)



- ✓ Merkezi kilit sistemi ve mandal sistemi
- Central lock system and handgrip lock system



- ✓ Teleskobik rulmanlı kızaklar tüm çekmeceler %100 açılabilir
- Telescopic slides which are %100 extendable.



- ✓ 9 Bölmeli, sağlam ABS tabla
- 9 Durable ABS worktop with divisions



- ✓ 2 sabit, 2 hareketli frenli tekerlek ø 100mm
- 2 swivel castors with brake 2 fixed castors ø 100 mm

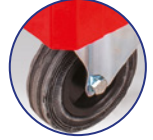

- ✓ Yüksek dayanımlı elektrostatik toz boya.
- High strength electrostatic powder coating

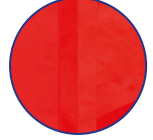

İZELTAS YOUTUBE

Ölçü/Size: 470x670x975 mm

Sacdan imal edilmiş, Fırın boya  
Made of sheet metal, Electrostatic paint

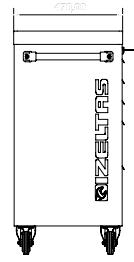
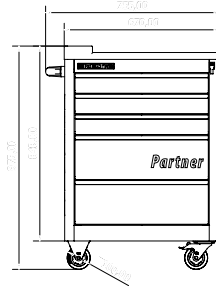



RAL 3020 GOF



RAL 5003 GOF



RAL 9005 GOF

KOD/CODE	ÇEKMECE DRAWERS			Kg	RENK COLORS	TL/Ad
		397x549x74	397x549x182			
8235 32 6005	5	3X	2X	56	RAL 3020 GOF	26.035,50
8235 32 5005	5	3X	2X	56	RAL 5003 GOF	26.035,50
8235 32 7005	5	3X	2X	56	RAL 9005 GOF	26.035,50
8235 00 6121 Dolu/Full 118 Parça/Pcs	5	3X	2X			54.114,75



## 1. Partner Seri Çekmece/Drawer

Kod / Code 8235 00 1072

KOD CODE	İÇERİK CONTENTS	TL/Ad
1107	<p><b>1/4" Altı Köşe Lokma Takımı</b> 1/4" Socket Wrench Set</p> <p><b>1/4" Cırcır kolu</b> Ratchet Handle</p> <p>4 - 5 - 6 7 - 8 - 9 - 10 11 - 12 - 13 <b>Altı Köşe</b> Six Points</p> <p><b>1/4" Mafsal</b> Universal Joint</p> <p><b>1/4" T Kol</b> Sliding T Handle</p> <p><b>1/4" Ara Kol</b> Extention Bar 50-100 mm</p> <p><b>1/2" Lokma Takımı</b> 1/2" Socket Set</p> <p><b>1/2" Cırcır Kolu 32 Diş</b> Ratchet Handle</p> <p>10 - 11 - 12 13 - 14 - 15 16 - 17 - 18 19 - 21 - 22 23 - 24 - 26 27 - 28 - 30 - 32</p> <p><b>1/2" Mafsal</b> Universal Joint</p> <p><b>1/2" T Kol Adaptör</b> Sliding T Handle Adapter</p> <p><b>1/2" Ara Kol</b> Extention Bar 125-250 mm</p>	15
1113	<p><b>1/4" Derin Lokma Tornavida Adaptörü</b> Spindle Handle</p> <p><b>12'li Allen Anahtar Takımı</b> Hex Key Wrench Set 2-2.5-3-3.5-4-5-6-7-8-9-10-12 mm</p> <p><b>8'li Torx Allen Anahtar Takımı</b> Torx Key Wrench T9-T10-T15-T20-T25-T27-T30-T40</p> <p><b>1/2" Altı Köşe Derin Lokma</b> Deep Socket Wrench 6 Point 10-13-16-17-18-19 mm</p> <p><b>1/2" 16 mm Buji Lokma Anahtar</b> Spark Plug Socket With Rubber</p>	1
1507	<p><b>240 mm Üniversal Fort Pense</b> Waterpump Pliers, Universal</p> <p><b>250 mm Üniversal Ayarlı Pense</b> Universal Grip</p>	14.976,00
4900		
4910		
1108		
1113		
2400		
2500		



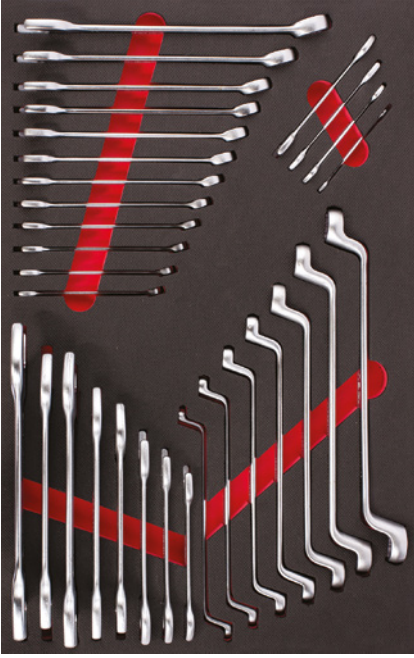

## 2. Partner Seri Çekmece/Drawer

Kod / Code 8235 00 2031

KOD CODE	İÇERİK CONTENTS	□	TL/Ad
0100	<b>İki Ağız Anahtar Kısa Boy</b> Double Ended Open Jaw Wrench Short Pattern 6x7 - 8x9 - 10x11 - 12x13 14x15 - 16x17 - 18x19 - 20x22 21x23 - 24x26 - 25x28 - 30x32	12	
0320	<b>Kombine Anahtar Kısa Boy</b> Combination Wrench Short Pattern 8 - 9 - 10 - 11 - 12 - 13 14 - 15 - 16 - 17 - 19 - 22	12	6.647,50
0430	<b>Yıldız Anahtar</b> Ring Wrench 8x9 - 10x11 - 12x13 - 14x15 - 16x17 18x19 - 20x22	7	



## 3. Partner Seri Çekmece/Drawer

Kod / Code 8235 00 3017

KOD CODE	İÇERİK CONTENTS	□	TL/Ad
4300	<b>Opak Seri Düz Uçlu Tornavida</b> Screwdriver, Opak Flat 3x80-4x80-4x100-5x125-6x150	5	
4320	<b>Opak Seri Yıldız Uçlu Tornavida</b> Screwdriver, Opak Philips 4.5x80-6x100	2	
3700	<b>Yan Keski Opak Seri</b> Side Cutting Pliers 160 mm	1	
3020	<b>Kombine Pense Opak Seri</b> Combination Pliers 180 mm	1	6.455,75
3220	<b>Düz Kargaburun Opak Seri</b> Nose Pliers Flat 200 mm	1	
4770	<b>Lokma Uçlu Tornavida</b> Nut Spinner 6-7-8-10-13	5	
5500	<b>Düz Keski</b> Flat Cold Chisel 150 mm	1	
5800	<b>Tesviyeci Çekiçi</b> Machinist's Hammer 500 gr	1	





## Eko Serisi Takım Dolabı (3-5-7 Çekmeceli) Eco Series Workshop Trolley (3-5-7 Drawers)



Ölçü/Size: 410x620x894 mm

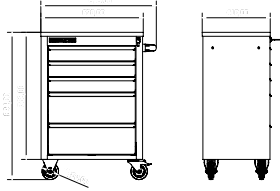

İZELTAS YOUTUBE

Sacdan imal edilmiş, Fırın boya  
Made of sheet metal, Electrostatic paint



- ✓ Merkezi kilit  
● Central locking



- ✓ %100 açılabilir teleskobik raylar  
● %100 extendable telescopic slides

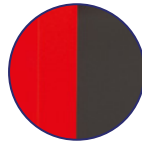

- ✓ Yüksek dayanımlı elektrostatik toz boya  
● High strength electrostatic powder coating

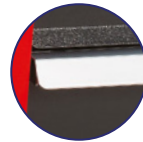

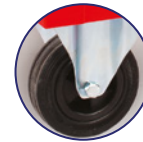

- ✓ Elok sallı alüminyum tutma çitası  
● Handle with anodised aluminum

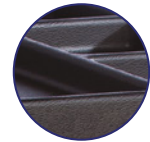

- ✓ 2 sabit, 2 hareketli frenli tekerlek ø 100 mm  
● 2 swivel castors with brake 2 fixed castors ø 100 mm



- ✓ 4 bölmeli sağlam ve dayanıklı ABS plastik üst malzeme tabla  
● Resistant and solid top cover with 4 divisions

KOD/CODE	ÇEKMECE DRAWERS			DEMONTÉ RAF DISASSEMBLED SHELF		RENK COLORS	TL/Ad
		350x503x82	350x503x176				
★ 8243 32 1003	3	3X	--	2	44.1	RAL 9005 60F	18.993,75
★ 8243 32 1005	5	3X	2X	--	46.1	RAL 3020 60F	18.993,75
★ 8243 32 1007	7	7X	--	--	51.9		25.463,50
★ 8243 32 2005	5	3X	2X	--	46.1	RAL 9005 60F	18.993,75
★ 8243 32 2007	7	7X	--	--	51.9	RAL 5003 60F	25.463,50
★ 8243 32 3005	5	3X	2X	--	46.1	RAL 7035 60F	18.993,75
★ 8243 32 3007	7	7X	--	--	51.9	RAL 9005 60F	25.463,50
★ 8243 00 1096	5	3X	2X	--		RAL 9005 60F	41.454,75
★ 8243 00 7096	7	7X	--	--		RAL 3020 60F	47.924,50
Dolu/Full 93 Parça/Pcs							
Dolu/Full 93 Parça/Pcs							

★ Stoklarla Sınırlıdır / It is Limited by Stocks.

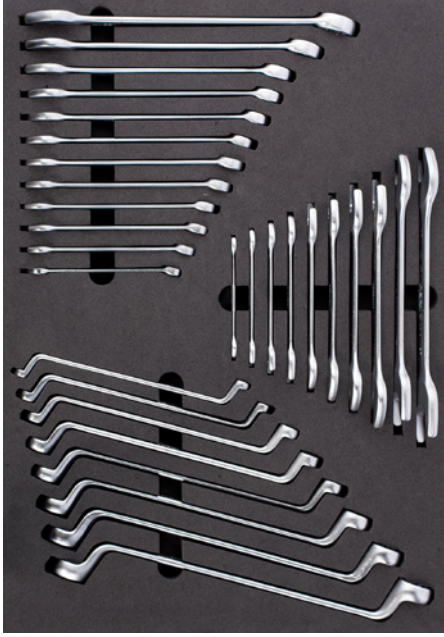

### 1. Eko Seri Çekmece/Drawer Kod / Code 8243 00 1030

KOD/CODE	İÇERİK CONTENTS	☐	TL/Ad.
0100	<b>İki Ağız Anahtar Kısa Boy</b> D/E Open Jaw Wrench Short Pattern 6x7 - 8x9 - 10x11 - 12x13 14x15 - 16x17 - 18x19 - 20x22 - 21x23 - 24x26	10	
0320	<b>Kombine Anahtar Kısa Boy</b> Combination Wrench Short Pattern 8 - 9 - 10 - 11 - 12 - 13 - 14 - 15 - 16 - 17 - 19 - 22	12	6.273,00
0430	<b>Yıldız Anahtar</b> Ring Wrench 6x7 - 8x9 - 10x11 - 12x13 - 14x15 - 16x17 18x19 - 20x22	8	



### 2. Eko Seri Çekmece/Drawer Kod / Code 8243 00 2052

KOD/CODE	İÇERİK CONTENTS	☐	TL/Ad.
1113	<b>1/2" 17'li Lokma Takımı</b> Socket Wrench Set 1/2" mm 10 - 11 - 12 - 13 - 14 - 15 - 17 - 19 22 - 24 - 27 - 30 - 32 250 - 250 - 70	17	
1107	<b>1/4" Altı Köşe Lokma Takımı</b> Socket Wrench Set 1/4" mm 4 - 5 - 6 - 7 - 8 - 9 - 10 - 11 - 12 - 13 140 - 115 - 100 - 50 - 38	15	9.511,00
4900	<b>Allen Anahtar Takımı</b> Hex Key Wrench Set 2 - 2.5 - 3 - 3.5 - 4 - 5 - 6 - 7 - 8 - 9 - 10 - 12	12	
4770	<b>Lokma Uçlu Tornavidalar</b> Nutspinners 6 - 7 - 8 - 10 - 13	5	



### 3. Eko Seri Çekmece/Drawer Kod / Code 8243 00 3013

KOD/CODE	İÇERİK CONTENTS	☐	TL/Ad.
4320	<b>Opak Seri Yıldız Uçlu Tornavida</b> Opak Screwdriver, Phillips 4,5x80-6x100	2	
4300	<b>Opak Seri Düz Uçlu Tornavida</b> Opak Screwdriver, Flat 4x100-5x125-6x150-8x175	4	
3700	<b>Yan Keski Opak Seri</b> Side Cutting Pliers 160 mm	1	
3020	<b>Kombine Pense Opak Seri</b> Combination Pliers 180 mm	1	
3220	<b>Kargaburun Düz Uçlu Opak Seri</b> Nose Pliers, Flat 160 mm	1	6.677,00
5500	<b>Düz Keski Krom</b> Flat Cold Chisel 150 mm	1	
5800	<b>Tesviyecici Çekici</b> Machinist's Hammer 300 gr	1	
2510	<b>Spesiyal Ayarlı Pense / Special Grip 250 mm</b>	1	
2400	<b>Üniversal Fort Pense / Waterpump Pliers Universal 240 mm</b>	1	

★ Stoklarla Sınırlıdır / It is Limited by Stocks.

**Trend Serisi Takım Dolabı (3-5-7 Çekmeceli)**
**Trend Series Workshop Trolley (3-5-7 Drawers)**

- ✓ 4 bölmeli sağlam ve dayanıklı ABS plastik üst malzeme tabla
- Resistant and solid top cover with 4 divisions

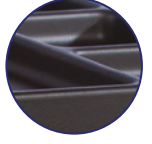

- ✓ %100 açılabilir teleskobik raylar
- %100 extendable telescopic slides



- ✓ Merkezi kilit
- Central locking





- ✓ 2 sabit, 2 hareketli frenli tekerlek ø 100 mm
- 2 swivel castors with brake 2 fixed castors ø 100 mm

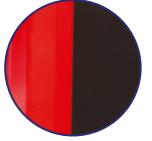
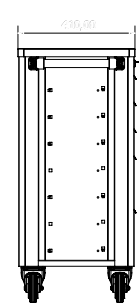
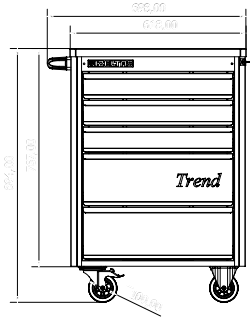

- ✓ Yüksek dayanımlı elektrostatik toz boya
- High strength electrostatic powder coating

**Ölçü/Size: 410x618x894 mm**

**İZELTAS YOUTUBE**

**Sacdan imal edilmiş, Fırın boya**  
**Made of sheet metal, Electrostatic paint**

KOD/CODE	ÇEKMECE DRAWERS	 25 kg	 25 kg	 Kg	RENK COLORS	TL/Ad
		<b>350x503x82</b>	<b>350x503x176</b>			
13000 005562	3	3X	--	38.2		18.691,25
8244 32 1005	5	3X	2X	40.7		19.070,00
8244 32 1007	7	7X	--	44.4		19.856,00
8244 00 5096	5	3X	2X		<b>RAL 9005 GOF</b>	41.531,00
Dolu/Full 93 Parça/Pcs					<b>RAL 3020 GOF</b>	
8244 00 7096	7	7X	--			42.317,00
Dolu/Full 93 Parça/Pcs						

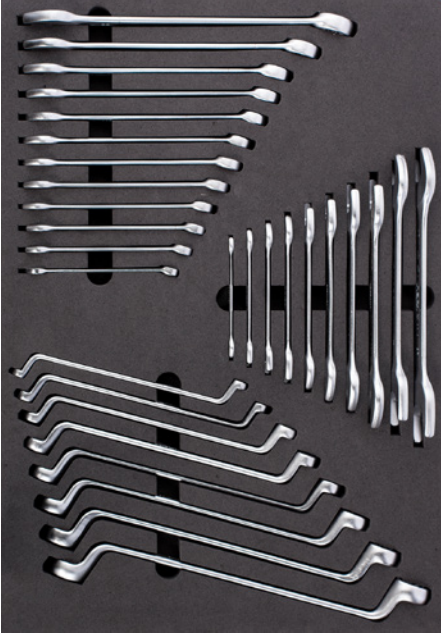



### 1. Trend Seri Çekmece/Drawer

Kod / Code 8244 00 1030

KOD/CODE	İÇERİK CONTENTS		TL/Ad.
0100	<b>İki Ağız Anahtar Kısa Boy</b> D/E Open Jaw Wrench Short Pattern 6x7 - 8x9 - 10x11 - 12x13 14x15 - 16x17 - 18x19 - 20x22 - 21x23 - 24x26	10	
0320	<b>Kombine Anahtar Kısa Boy</b> Combination Wrench Short Pattern 8 - 9 - 10 - 11 - 12 - 13 - 14 - 15 - 16 - 17 - 19 - 22	12	6.273,00
0430	<b>Yıldız Anahtar</b> Ring Wrench 6x7 - 8x9 - 10x11 - 12x13 - 14x15 - 16x17 18x19 - 20x22	8	



### 2. Trend Seri Çekmece/Drawer

Kod / Code 8244 00 2052

KOD/CODE	İÇERİK CONTENTS		TL/Ad.
1113	<b>1/2" 17'li Lokma Takımı</b> Socket Wrench Set 1/2" mm 10 - 11 - 12 - 13 - 14 - 15 - 17 - 19 - 22 - 24 - 27 - 30 - 32 250 - 250 - 70	17	
1107	<b>1/4" Altı Köşe Lokma Takımı</b> Socket Wrench Set 1/4" mm 4 - 5 - 6 - 7 - 8 - 9 - 10 - 11 - 12 - 13 140 - 115 - 100 - 50 - 38	15	9.511,00
4900	<b>Allen Anahtar Takımı</b> Hex Key Wrench Set 2 - 2.5 - 3 - 3.5 - 4 - 5 - 6 - 7 - 8 - 9 - 10 - 12	12	
4770	<b>Lokma Uçlu Tornavidalar</b> Nutspinners 6 - 7 - 8 - 10 - 13	5	



### 3. Trend Seri Çekmece/Drawer

Kod / Code 8244 00 3013

KOD/CODE	İÇERİK CONTENTS		TL/Ad.
4320	<b>Opak Seri Yıldız Uçlu Tornavida</b> Opak Screwdriver, Phillips 4.5x80-6x100	2	
4300	<b>Opak Seri Düz Uçlu Tornavida</b> Opak Screwdriver, Flat 4x100-5x125-6x150-8x175	4	
3700	<b>Yan Keski Opak Seri</b> Side Cutting Pliers 160 mm	1	
3020	<b>Kombine Pense Opak Seri</b> Combination Pliers 180 mm	1	6.677,00
3220	<b>Kargaburun Düz Uçlu Opak Seri</b> Nose Pliers, Flat 160 mm	1	
5500	<b>Düz Keski Krom</b> Flat Cold Chisel 150 mm	1	
5800	<b>Tesviyeci Çekici</b> Machinist Hammer 300 gr	1	
2510	<b>Special Ayarlı Pense / Special Grip 250 mm</b>	1	
2400	<b>Üniversal Fort Pense / Waterpump Pliers Universal 240 mm</b>	1	

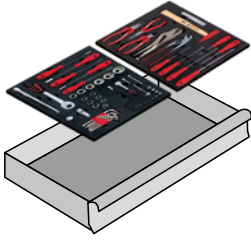
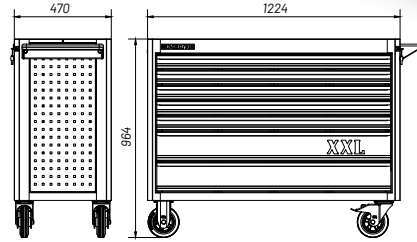
**Takım Dolabı Ahşap Üst Tablalı XXL (7 Çekmeceli)**  
**XXL Series Workshop Trolley (7 Drawers)**

**Ölçü/Size: 470x1224x964 mm**

Aşağıda yazılı olan muhteviyatlı süngerlerden her bir çekmeceye İKİ (2) adet yerleştirilebilir.

- |                                |                         |
|--------------------------------|-------------------------|
| 1. Premium Seri Çekmece/Drawer | Kod / Code 8245 00 1042 |
| 2. Premium Seri Çekmece/Drawer | Kod / Code 8245 00 2094 |
| 3. Premium Seri Çekmece/Drawer | Kod / Code 8245 00 3014 |
| 4. Premium Seri Çekmece/Drawer | Kod / Code 8245 00 4043 |
| 5. Premium Seri Çekmece/Drawer | Kod / Code 8245 00 5043 |
| 6. Premium Seri Çekmece/Drawer | Kod / Code 8245 00 6009 |
| 1. Pro Seri Çekmece/Drawer     | Kod / Code 8241 00 1030 |
| 2. Pro Seri Çekmece/Drawer     | Kod / Code 8241 00 2072 |
| 3. Pro Seri Çekmece/Drawer     | Kod / Code 8241 00 3051 |
| 4. Pro Seri Çekmece/Drawer     | Kod / Code 8241 00 4027 |
| 5. Pro Seri Çekmece/Drawer     | Kod / Code 8241 00 5010 |
| 6. Pro Seri Çekmece/Drawer     | Kod / Code 8241 00 6018 |
| 1. Elite Seri Çekmece/Drawer   | Kod / Code 13000 005573 |
| 2. Elite Seri Çekmece/Drawer   | Kod / Code 13000 005574 |
| 3. Elite Seri Çekmece/Drawer   | Kod / Code 13000 005575 |
| 4. Elite Seri Çekmece/Drawer   | Kod / Code 13000 005576 |
| 5. Elite Seri Çekmece/Drawer   | Kod / Code 13000 005577 |
| 1. Partner Seri Çekmece/Drawer | Kod / Code 8235 00 1072 |
| 2. Partner Seri Çekmece/Drawer | Kod / Code 8235 00 2031 |
| 3. Partner Seri Çekmece/Drawer | Kod / Code 8235 00 3017 |

- ✓ 18mm masif üst tabla
- 18 mm solid wood top



- ✓ %100 açılabilir teleskobik raylar
- %100 extendable telescopic slides



- ✓ Merkezi kilit
- ✓ Mandal sistemi
- ✓ Devrilme emniyet sistemi
- Central lock
- Handgrip Lock system
- Anti tilt system



- ✓ Ergonomik sap
- Ergonomic handle





- ✓ 2 sabit, 2 hareketli frenli tekerlek ø 150mm
- 2 swivel castors with brake
- 2 fixed castors ø 150mm

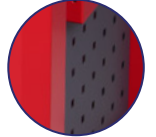

- ✓ Yüksek dayanımlı elektrostatik toz boya
- High strength electrostatic powder coating.



**Sacdan imal edilmiş, Fırın boya**  
**Made of sheet metal, Electrostatic paint**

KOD/CODE	ÇEKMECE DRAWERS				RENK COLORS	TL/Ad
		1098x400x60	1098x400x135			

8246 32 1007

7

5X

2X

125.7

RAL 9005 GOF

RAL 3020 GOF

47.742,50

8247 32 1007

**Takım Dolabı Ahşap Üst Tablalı Workbench (7 Çekmeceli)**  
Workbench Series Workshop Trolley (7 Drawers)

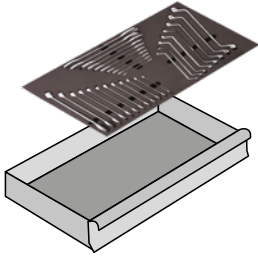

Ölçü/Size: 500x1150x991 mm

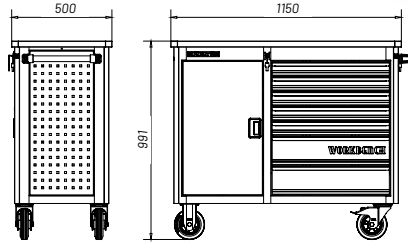

Aşağıda yazılı olan muhteviyatlı süngerlerden her bir çekmeceye BİR (1) adet yerleştirilebilir.

- |                                |                         |
|--------------------------------|-------------------------|
| 1. Premium Seri Çekmece/Drawer | Kod / Code 8245 00 1042 |
| 2. Premium Seri Çekmece/Drawer | Kod / Code 8245 00 2094 |
| 3. Premium Seri Çekmece/Drawer | Kod / Code 8245 00 3014 |
| 4. Premium Seri Çekmece/Drawer | Kod / Code 8245 00 4043 |
| 5. Premium Seri Çekmece/Drawer | Kod / Code 8245 00 5043 |
| 6. Premium Seri Çekmece/Drawer | Kod / Code 8245 00 6009 |
| 1. Pro Seri Çekmece/Drawer     | Kod / Code 8241 00 1030 |
| 2. Pro Seri Çekmece/Drawer     | Kod / Code 8241 00 2072 |
| 3. Pro Seri Çekmece/Drawer     | Kod / Code 8241 00 3051 |
| 4. Pro Seri Çekmece/Drawer     | Kod / Code 8241 00 4027 |
| 5. Pro Seri Çekmece/Drawer     | Kod / Code 8241 00 5010 |
| 6. Pro Seri Çekmece/Drawer     | Kod / Code 8241 00 6018 |
| 1. Elite Seri Çekmece/Drawer   | Kod / Code 13000 005573 |
| 2. Elite Seri Çekmece/Drawer   | Kod / Code 13000 005574 |
| 3. Elite Seri Çekmece/Drawer   | Kod / Code 13000 005575 |
| 4. Elite Seri Çekmece/Drawer   | Kod / Code 13000 005576 |
| 5. Elite Seri Çekmece/Drawer   | Kod / Code 13000 005577 |
| 1. Partner Seri Çekmece/Drawer | Kod / Code 8235 00 1072 |
| 2. Partner Seri Çekmece/Drawer | Kod / Code 8235 00 2031 |
| 3. Partner Seri Çekmece/Drawer | Kod / Code 8235 00 3017 |

- ✓ 30 mm masif ahşap üst tabla
- 30 mm solid wood top

- ✓ %100 açılabilir teleskobik raylar
- %100 extendable telescopic slides

- ✓ Merkezi kilit
- ✓ Mandal sistemi
- ✓ Devrilme emniyet sistemi
- Central lock
- Handgrip Lock system
- Anti tilt system

- ✓ Standard tutma sapı
- Standard handle

- ✓ 2 sabit, 2 hareketli frenli tekerlek ø 150mm
- 2 swivel castors with brake 2 fixed castors ø 150mm

- ✓ Yüksek dayanımlı elektrostatik toz boya
- High strength electrostatic powder coating

- ✓ 4 kısa, 2 uzun seperetör
- 4 Short, 2 long separators

Sacdan imal edilmiş, Fırın boya  
Made of sheet metal, Electrostatic paint

KOD/CODE	ÇEKMECE DRAWERS				RENK COLORS	TL/Ad
		400x548x60	400x548x134			

8247 32 1007

7

5X

2X

102.7

RAL 9005 GOF

RAL 3020 GOF

44.804,00

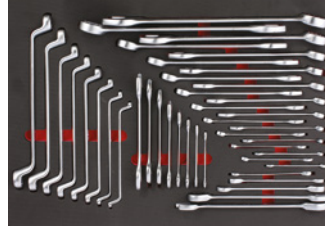
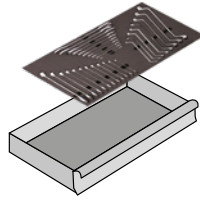

**Premium**

Premium Seri Çekmece 1  
Kod / Code 8245 00 1042  
**Sayfa 14**

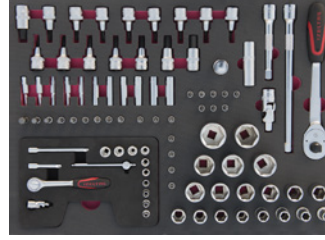
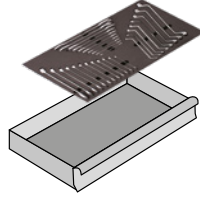
**Pro**

Premium Seri Çekmece 2  
Kod / Code 8245 00 2094  
**Sayfa 14**

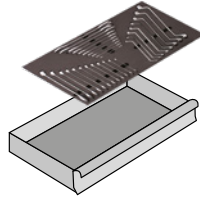
**Elite**

Premium Seri Çekmece 3  
Kod / Code 8245 00 3014  
**Sayfa 14**

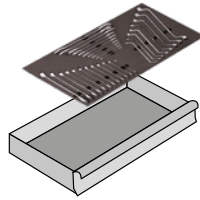
**Partner**

Premium Seri Çekmece 4  
Kod / Code 8245 00 4043  
**Sayfa 15**

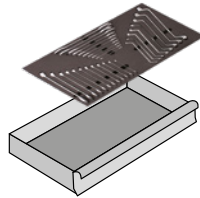
**Workbench**

Premium Seri Çekmece 5  
Kod / Code 8245 00 5043  
**Sayfa 15**

**XXL**

Premium Seri Çekmece 6  
Kod / Code 8245 00 6009  
**Sayfa 15**

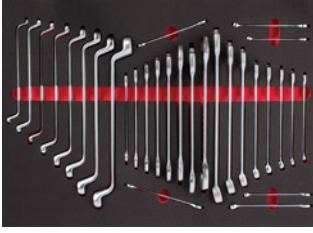

Pro Seri Çekmece 1  
Kod / Code 8241 00 1030  
**Sayfa 18**

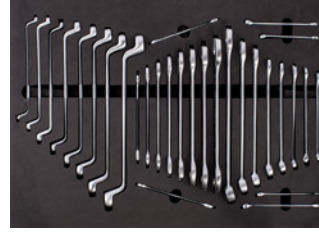

Elite Seri Çekmece 1  
Kod / Code 13000 005573  
**Sayfa 30**

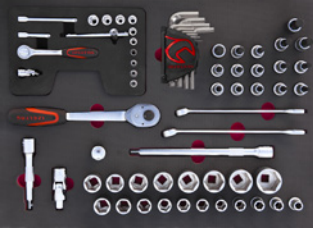

Pro Seri Çekmece 2  
Kod / Code 8241 00 2072  
**Sayfa 18**

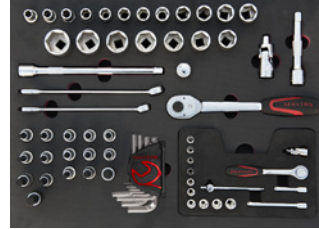

Elite Seri Çekmece 2  
Kod / Code 13000 005574  
**Sayfa 30**



Pro Seri Çekmece 3  
Kod / Code 8241 00 3051  
**Sayfa 18**



Elite Seri Çekmece 3  
Kod / Code 13000 005575  
**Sayfa 31**

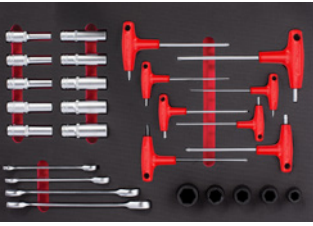

Pro Seri Çekmece 4  
Kod / Code 8241 00 4027  
**Sayfa 19**



Elite Seri Çekmece 4  
Kod / Code 13000 005576  
**Sayfa 31**



Pro Seri Çekmece 5  
Kod / Code 8241 00 5010  
**Sayfa 19**

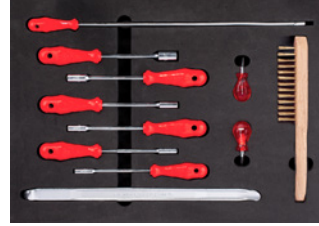

Elite Seri Çekmece 5  
Kod / Code 13000 005577  
**Sayfa 31**



Pro Seri Çekmece 6  
Kod / Code 8241 00 6018  
**Sayfa 19**

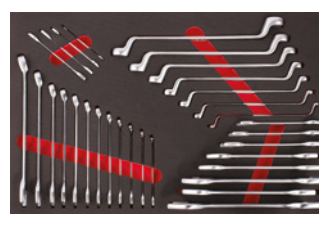

Partner Seri Çekmece 2  
Kod / Code 8235 00 2031  
**Sayfa 35**



Partner Seri Çekmece 1  
Kod / Code 8235 00 1072  
**Sayfa 34**



Partner Seri Çekmece 3  
Kod / Code 8235 00 3017  
**Sayfa 35**

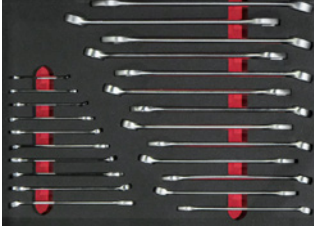

Grand Master Çekmece 1 - Sol  
Kod / Code 13000 005590  
**Sayfa 7**

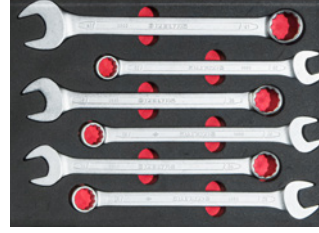

Grand Master Çekmece 1 - Sağ  
Kod / Code 13000 005589  
**Sayfa 7**

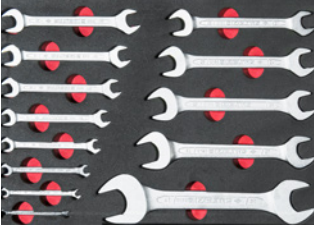

Grand Master Çekmece 2 - Sol  
Kod / Code 13000 005591  
**Sayfa 7**

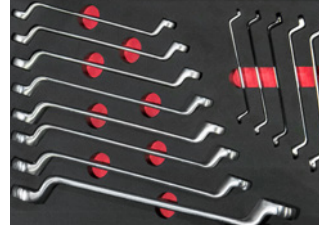

Grand Master Çekmece 2 - Sağ  
Kod / Code 13000 005592  
**Sayfa 7**



Grand Master Çekmece 3- Sol  
Kod / Code 13000 005594  
**Sayfa 8**



Grand Master Çekmece 3 - Sağ  
Kod / Code 13000 005593  
**Sayfa 8**



Grand Master Çekmece 4- Sol  
Kod / Code 13000 005595  
**Sayfa 9**

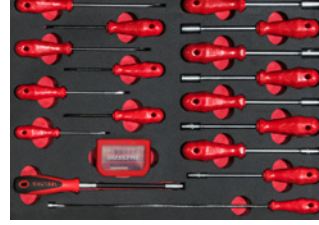

Grand Master Çekmece 4 - Sağ  
Kod / Code 13000 005596  
**Sayfa 9**

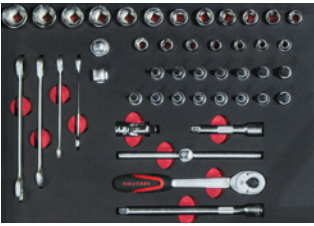

Grand Master Çekmece 5 - Sol  
Kod / Code 13000 005598  
**Sayfa 10**



Grand Master Çekmece 5 - Sağ  
Kod / Code 13000 005597  
**Sayfa 10**



Grand Master Çekmece 6 - Sol  
Kod / Code 13000 005600  
**Sayfa 11**



Grand Master Çekmece 6 - Sağ  
Kod / Code 13000 005599  
**Sayfa 11**





**Vagon Serisi Takım Dolabı**  
Wagon Series Workshop Trolley

Ölçü/Size: 474x670x1020 mm

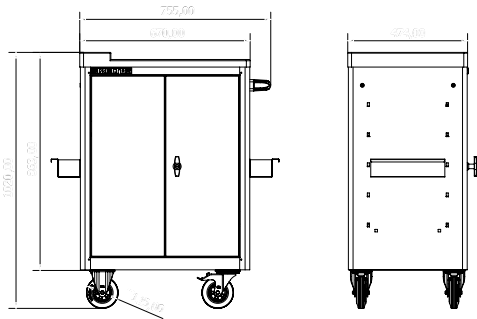

- ✓ 9 Bölmeli, sağlam ABS tabla
- Durable ABS worktop with divisions



- ✓ Kilit T Kol
- Locked T-handle



- ✓ 2 Sabit, 2 hareketli frenli tekerlek ø 125mm
- 2 swivel castors with brake 2 fixed castors ø 125 mm



- ✓ Yüksek dayanımlı elektrostatik toz boya.
- High strength electrostatic powder coating



- ✓ 2X ayarlanabilir raf (10 adet seperatör ile)
- 2x adaptable shelves with seperator 10 pcs



- ✓ Standard tutma sapı
- Standard handle

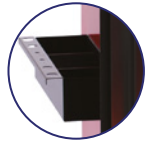

- ✓ 2X avadamlık
- 2X tin holder

**Sacdan imal edilmiş, Fırın boya**  
Made of sheet metal, Electrostatic paint

KOD/CODE	Ölçü / SIZE (mm)	Kg	RENK COLORS	TL/Ad.
8210 32 6001	474x670x1020	45	RAL 9005 GOF RAL 3020 GOF	20.087,25



8160 32 6001

Takım Dolabı  
Tool Cabinet



- ✓ Kollu kilit
- Locked T-handle



- ✓ %100 açılabilir teleskobik raylar
- %100 extendable telescopic slides



- ✓ 4 hareketli frenli tekerlek ø 50mm
- 4 swivel castors with brake ø 50 mm



- ✓ Yüksek dayanımlı elektrostatik toz boya
- High strength electrostatic powder coating



- ✓ Avadanlık x2
- Bottle and tins holder x2



- ✓ Askılık x4
- Hanger x4



- ✓ Özel askılık x4
- Special hanger x4



- ✓ Anahtar askısı x1
- Hanger for wrenches x1

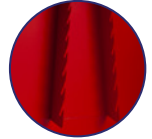

- ✓ Özel avadanlık x1
- Special tin holder x1

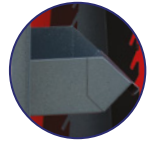

- ✓ Matkap ucu tutucu x1
- Drill bits holder x1



Ölçü/Size: 310x700x1050 mm

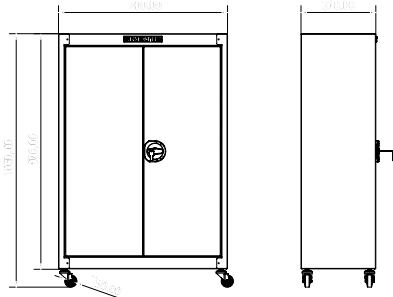

Sacdan imal edilmiş, Fırın boya  
Made of sheet metal, Electrostatic paint

KOD/CODE		Ölçü / SIZE (mm)	 Kg	COLORS	TL/Ad.
	228x567x58				

8160 32 6001

3x

310x700x1050

35

RAL 9005 GOF

RAL 3020 GOF

18.116,75



**Soyunma Dolabı Dar L 1800**  
Thin Locker

- ✓ 120° derece açılabilir kapak
- 120 degree openable cover
- ✓ 10 kg raf taşıma kapasitesi
- 10 kg shelf carrying capacity
- ✓ Tek kapaklı, 2 raflı, 3 bölmeli
- Single door, 2 shelves, 3 compartments
- ✓ Birinci kalite sağlam sac metal yapı
- Premium sheet metal construction
- ✓ Yüksek dayanımlı elektrostatik toz boya
- High strength electrostatic powder coating
- ✓ 4 adet kıyafet askısı
- 4 clothes hangers
- ✓ Asma kilit takılabilen kilit mekanizması
- Padlockable locking mechanism
- ✓ Kapak alt ve üst kısımlarda havalandırma ızgaraları
- Ventilation grilles
- ✓ Dolabın dengede durmasını sağlayan, zemini çizmeyen plastik pingo ayak
- Plastic leg that provide balance and do not scratch the floor
- ✓ Kapakları gizli menteşe
- Hidden hinge
- ✓ Yan yüzeylerde kullanılan destek sacları sayesinde darbeye karşı dayanıklılık
- Impact resistant support sheets used on the side surfaces
- ✓ Birbirine kolay montajlanabilir şekilde tasarlanmıştır.
- Easy to assemble together

RAL 9005 G0F

RAL 7035 G0F

Genişlik / Width 300 mm  
Derinlik / Depth 400 mm  
Yükseklik / Height 1800 mm

KOD/CODE	Ölçü / SIZE (mm)	Kg	TL/Ad.
13000 005399	300x400x1800	24.20	7.159,25

► Minimum sipariş adetlerine bağlı olarak renk seçenekleri mevcuttur. / Color options available depending on the order amount.

Sacdan imal edilmiş, Fırın boya  
Made of sheet metal, Electrostatic paint

13000 005400

Soyunma Dolabı Geniş L 1800  
Wide Locker



- ✓ 120° derece açılabilir kapak
- 120 degree openable cover
- ✓ 10 kg raf taşıma kapasitesi
- 10 kg shelf carrying capacity
- ✓ Tek kapaklı, 2 raflı, 3 bölmeli
- Single door, 2 shelves, 3 compartments
- ✓ Birinci kalite sağlam sac metal yapı
- Premium sheet metal construction
- ✓ Yüksek dayanımlı elektrostatik toz boya
- High strength electrostatic powder coating
- ✓ 4 adet kıyafet askısı
- 4 clothes hangers
- ✓ Asma kilit takılabilen kilit mekanizması
- Padlockable locking mechanism
- ✓ Kapak alt ve üst kısımlarda havalandırma ızgaraları
- Ventilation grilles
- ✓ Dolabın dengede durmasını sağlayan, zemini çizmeyen plastik pingo ayak
- Plastic leg that provide balance and do not scratch the floor
- ✓ Kapakları gizli menteşe
- Hidden hinge
- ✓ Yan yüzeylerde kullanılan destek sacları sayesinde darbeye karşı dayanıklılık
- Impact resistant support sheets used on the side surfaces
- ✓ Birbirine kolay montajlanabilir şekilde tasarlanmıştır.
- Easy to assemble together

RAL 9005 G0F

Genişlik / Width 400 mm  
Derinlik / Depth 400 mm  
Yükseklik / Height 1800 mm

RAL 7035 G0F

KOD/CODE	Ölçü / SIZE (mm)	Kg	TL/Ad.
13000 005400	400x400x1800	26.20	8.711,00

Sacdan imal edilmiş, Fırın boya  
Made of sheet metal, Electrostatic paint

► Minimum sipariş adetlerine bağlı olarak renk seçenekleri mevcuttur. / Color options available depending on the order amount.

**Soyunma Dolabı Orta Dar L 900**  
Medium Locker Thin**Soyunma Dolabı Orta Geniş L 900**  
Medium Locker Wide

- ✓ 120° derece açılabilir kapak
- 120 degree openable cover
- ✓ 10 kg raf taşıma kapasitesi
- 10 kg shelf carrying capacity
- ✓ Tek kapaklı, 2 bölmeli
- Single door, 1 shelves, 2 compartments
- ✓ Birinci kalite sağlam sac metal yapı
- Premium sheet metal construction
- ✓ Yüksek dayanımlı elektrostatik toz boya
- High strength electrostatic powder coating

- ✓ Asma kilit takılabilen kilit mekanizması
- Padlockable locking mechanism
- ✓ Kapak alt ve üst kısımlarda havalandırma ızgaraları
- Ventilation grilles on up and down sides of the door
- ✓ Kapakları gizli menteşe
- Hidden hinge
- ✓ Birbirine kolay montajlanabilir şekilde tasarlanmıştır.
- Easy to assemble together

RAL 9005 GOF

RAL 7035 GOF

Genişlik / Width 300 mm  
Derinlik / Depth 400 mm  
Yükseklik / Height 900 mm

RAL 9005 GOF

RAL 7035 GOF

Genişlik / Width 400 mm  
Derinlik / Depth 400 mm  
Yükseklik / Height 900 mm

Sacdan imal edilmiş, Fırın boya  
Made of sheet metal, Electrostatic paint

Sacdan imal edilmiş, Fırın boya  
Made of sheet metal, Electrostatic paint

KOD/CODE	Ölçü / SIZE (mm)	Kg	TL/Ad.
13000 005566	300x400x900	12.5	4.297,25

KOD/CODE	Ölçü / SIZE (mm)	Kg	TL/Ad.
13000 005567	400x400x900	13.2	5.227,25

► Minimum sipariş adetlerine bağlı olarak renk seçenekleri mevcuttur. / Color options available depending on the order amount.



13000 005564

Soyunma Dolabı Kısa Dar L 450  
Cube Locker Thin



13000 005565

Soyunma Dolabı Kısa Geniş L 450  
Cube Locker Wide



- ✓ 120° derece açılabilir kapak
- 120 degree openable cover
- ✓ Tek kapaklı, tek bölmeli
- Single door, 1 shelves
- ✓ Birinci kalite sağlam sac metal yapı
- Premium sheet metal construction
- ✓ Yüksek dayanımlı elektrostatik toz boya
- High strength electrostatic powder coating

- ✓ Asma kilit takılabilen kilit mekanizması
- Padlockable locking mechanism
- ✓ Kapak alt ve üst kısımlarda havalandırma ızgaraları
- Ventilation grilles on up and down sides of the door
- ✓ Kapakları gizli menteşe
- Hidden hinge
- ✓ Birbirine kolay montajlanabilir şekilde tasarlanmıştır.
- Easy to assemble together

RAL 9005 GOF

RAL 7035 GOF

Genişlik / Width 300 mm  
Derinlik / Depth 400 mm  
Yükseklik / Height 450 mm

RAL 9005 GOF

RAL 7035 GOF

Genişlik / Width 400 mm  
Derinlik / Depth 400 mm  
Yükseklik / Height 450 mm

Sacdan imal edilmiş, Fırın boya  
Made of sheet metal, Electrostatic paint

Sacdan imal edilmiş, Fırın boya  
Made of sheet metal, Electrostatic paint

KOD/CODE	Ölçü / SIZE (mm)	Kg	TL/Ad.
13000 005564	300x400x450	6.15	2.863,25

KOD/CODE	Ölçü / SIZE (mm)	Kg	TL/Ad.
13000 005565	400x400x450	7.10	3.485,00

► Minimum sipariş adetlerine bağlı olarak renk seçenekleri mevcuttur. / Color options available depending on the order amount.

### Çekmeceli Servis Arabası Service Trolley With Drawers



- 2X Çekmece, 35 kg Taşıma Kapasitesi  
2X Drawers, 35 kg Loading Capacity
- Devrilme Emniyet Sistemli %100 Açılabilir Teleskopik Rulmanlı Yay  
Telescopic Slides Which Are %100 extendable, handgrip lock system
- Merkezi Kilit Sistemi  
Central lock system
- 3 Adet Kauçuk Kaydırmaz Mat, 10 Adet Seperatör  
3X Rubber Anti Slipping Mats, 10 Separators
- 2 Sabit, 2 Hareketli, Frenli Tekerlek  
2X Fixed, 2x Swivel Castors with Brake
- 1 Adet Demonte Raf  
1X Demountable Shelf
- 2 Adet Sabit Raf, 50 kg Taşıma Kapasitesi  
2X Fixed Shelf, loading capacity per shelf 50 kg

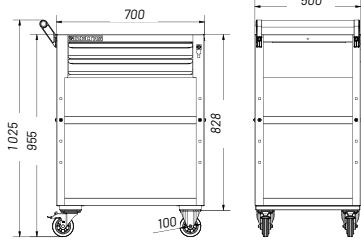

Çelik konstrüksiyon  
Steel construction

KOD/CODE	Ölçü / SIZE (mm)	Kg	RENK COLORS	TL/Ad.
13000 005560	500x700x955	31.10	RAL 9005 GOF RAL 3020 GOF	16.851,75

### 8550

### Demonte Mini Servis Arabası Disassembled Mini Service Trolley

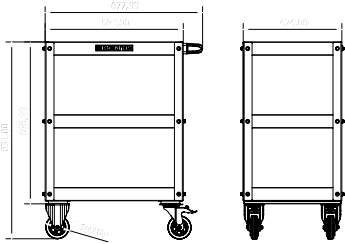

- 3X Kauçuk Kaydırmaz Mat  
3X Rubber Anti Slipping Mats
- 2X Sabit, 2X Hareketli Frenli Tekerlek (ø 100 mm)  
2X Fixed, 2X Swivel Castors with Brake (ø 100 mm)
- Sağlam sac metal yapı, Her raf 50 Kg taşır.  
Robust sheet-steel construction, Loading capacity per shelf 50 Kg

Kapalı  
8550 34 8002

Açık  
8550 34 8001

Çelik konstrüksiyon  
Steel construction

KOD/CODE	50 kg	Ölçü / SIZE (mm)	Kg	RENK COLORS	TL/Ad.
8550 34 8001	420x590x57	424x594x851	18	RAL 9005 GOF RAL 3020 GOF	8.423,00
8550 34 8002	420x590x57	424x594x851	23	RAL 9005 GOF RAL 3020 GOF	9.713,00

8545 34 1005

**Taşıma Arabası**  
Platform Wagon

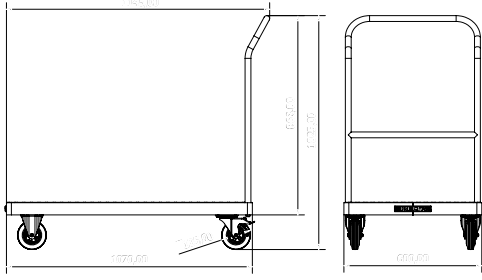

- **12mm PVC kaplı kontrplak Tabla**  
12mm PVC coated plywood
- **2X Sabit, 2X Hareketli Frenli Tekerlek (ø 125mm)**  
2X Fixed, 2X Swivel Castors with Brake (ø 125mm)
- **Sağlam sac metal yapı, 310 Kg taşır.**  
Robust sheet-steel construction, Loading capacity per shelf 310 Kg

Çelik konstrüksiyon  
Steel construction

KOD/CODE	Ölçü / SIZE (mm)	Kg	RENK COLORS	TL/Ad.
8545 34 1005	600x1145x1025	38	RAL 9005 GOF	25.515,75

8550 34 6001

**Servis Arabası (Büyük Boy)**  
Service Trolley (Large Size)

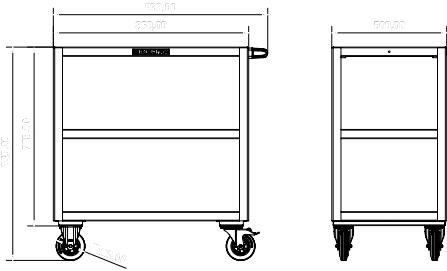

- **3X Kauçuk Kaydırmaz Mat**  
3X Rubber Anti Slipping Mats
- **2X Sabit, 2X Hareketli Frenli Tekerlek (ø 125 mm)**  
2X Fixed, 2X Swivel Castors with Brake (ø 125 mm)
- **Sağlam sac metal yapı, Her raf 75 Kg taşır.**  
Robust sheet-steel construction, Loading capacity per shelf 75 Kg

Çelik konstrüksiyon  
Steel construction



KOD/CODE	Ölçü / SIZE (mm)	Kg	RENK COLORS	TL/Ad.
8550 34 6001	500x850x935	37	RAL 3020 GOF	13.987,25

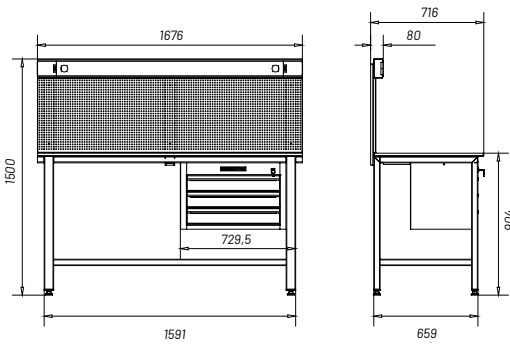

**Servis Masası (Panolu)**  
Work Bench (With Panel)

- **Merkezi kilit sistemi, mandal sistemi**  
Central locking system, handgrip lock system
- **Kaynaklı sağlam tasarım**  
Robust welded design
- **%100 Açılabilir teleskobik raylar**  
100% extendable telescopic slides
- **Yüksek dayanımlı elektrostatik toz boya.**  
High strength electrostatic powder paint
- **Delikli panel (220 V prizler ile).**  
Perforated panel with electrical plugs 220 V

**Çelik Konstrüksiyon ve zor koşullarda çalışmaya elverişli**  
**Özel Plywood ahşap tezgah**  
Strong and durable steel construction and Plywood bench

KOD/CODE		Ölçü / SIZE (mm)	 Kg	RENK COLORS	TL/Ad.
8500 34 6001	3X	720x1680x1495	102	<b>RAL 9005 GOF</b> <b>RAL 3020 GOF</b>	34.991,00

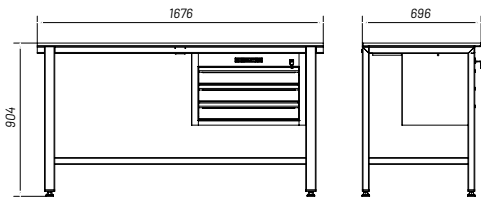

8501 34 6001

**Servis Masası (Panosuz)**  
Work Bench (Without Panel)

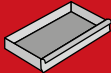

- **Merkezi kilit sistemi, mandal sistemi**  
Central locking system, handgrip lock system
- **Kaynaklı sağlam tasarım**  
Robust welded design
- **%100 Açılabilir teleskobik raylar**  
100% extendable telescopic slides
- **Yüksek dayanımlı elektrostatik toz boya.**  
High strength electrostatic powder paint

**Çelik konstrüksiyon ve zor koşullarda çalışmaya elverişli**  
**Özel Plywood ahşap tezgah**  
Strong and durable steel construction and Plywood bench

KOD/CODE		Ölçü / SIZE (mm)	 Kg	RENK COLORS	TL/Ad.
8501 34 6001	3X 348x548x90	700x1680x900	84	RAL 9005 GOF RAL 3020 GOF	26.493,75

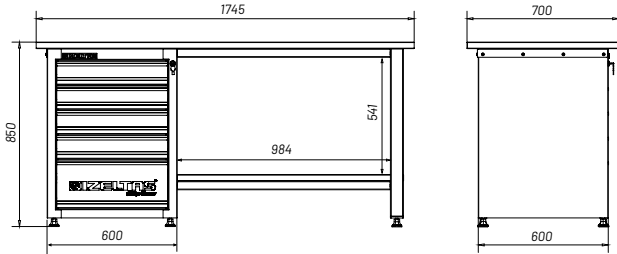
**Demonte Atölye Masası**  
Disassembled Workbench

- ✓ %100 açılabilir teleskobik raylar.
- %100 extendable telescopic slides





- ✓ Merkezi kilit
- ✓ Mandal sistemi
- Central lock
- Handgrip Lock system



- Demonte sağlam tasarım  
Robust disassembled design
- 30mm masif ahşap  
30 mm solid wood
- Ayarlanabilir ayaklar  
Height adjustable feet

**Çelik konstrüksiyon**  
Steel construction





KOD/CODE	ÇEKMECE DRAWERS				RENK COLORS	TL/Ad
8502 34 6002	5	4X	1X	145	RAL 7016 GOF RAL 3020 GOF	89.454,00

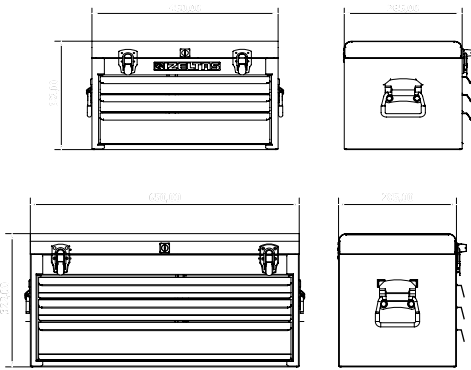



**Çekmeceli Alet Sandığı**  
**Tool Chest With Drawers**

**RAL 3020 G0F**

Sacdan imal edilmiş, Fırın boya  
 Made from metal sheet, Electrostatic paint

KOD/CODE	ÖLÇÜ / SIZE (mm)	ÇEKMECE DRAWERS	 2x	 1x	 Kg		TL/Ad
8320 33 1001	285x450x322	3X	238x370x47	238x370x87	16	1	11.622,00
8320 33 1003	285x650x322	3X	238x570x47	238x570x87	20	1	12.716,50



8410

**Takım Çantası (3 Gözlü)**  
Tool Box (3 Trays)

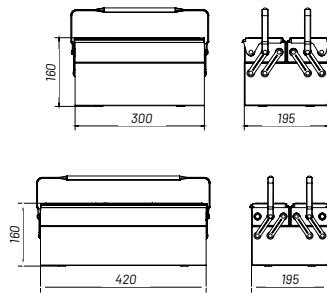

RAL 9005 GOF

RAL 3020 GOF

**Sacdan imal edilmiş, Fırın boya**  
Made from metal sheet, Electrostatic paint

KOD CODE	ÖLÇÜ / SIZE (mm)	g	TL/Ad.
8410 33 6103	195x300x160	2400	1 1.483,25
8410 33 6203	195x420x160	3000	1 1.772,50

8420

**Takım Çantası (5 Gözlü)**  
Tool Box (5 Trays)

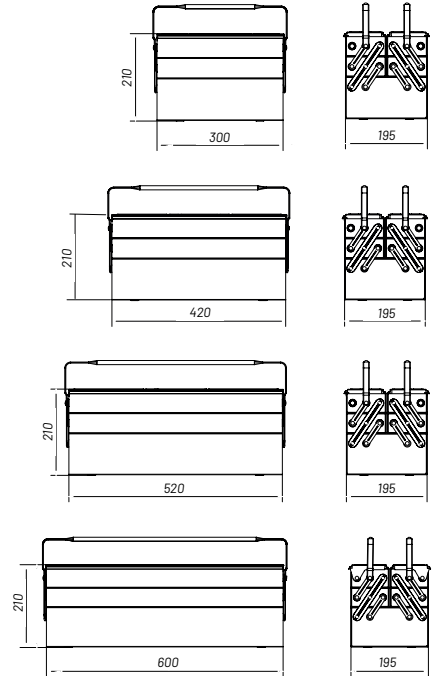

RAL 9005 GOF

RAL 3020 GOF

**Sacdan imal edilmiş, Fırın boya**  
Made from metal sheet, Electrostatic paint

KOD CODE	ÖLÇÜ / SIZE (mm)	g	TL/Ad.
8420 33 6105	195x300x210	3200	1 2.610,00
8420 33 6205	195x420x210	4200	1 2.702,50
8420 33 6305	195x520x210	5000	1 3.140,50
8420 33 6405	195x600x210	5600	1 3.309,75

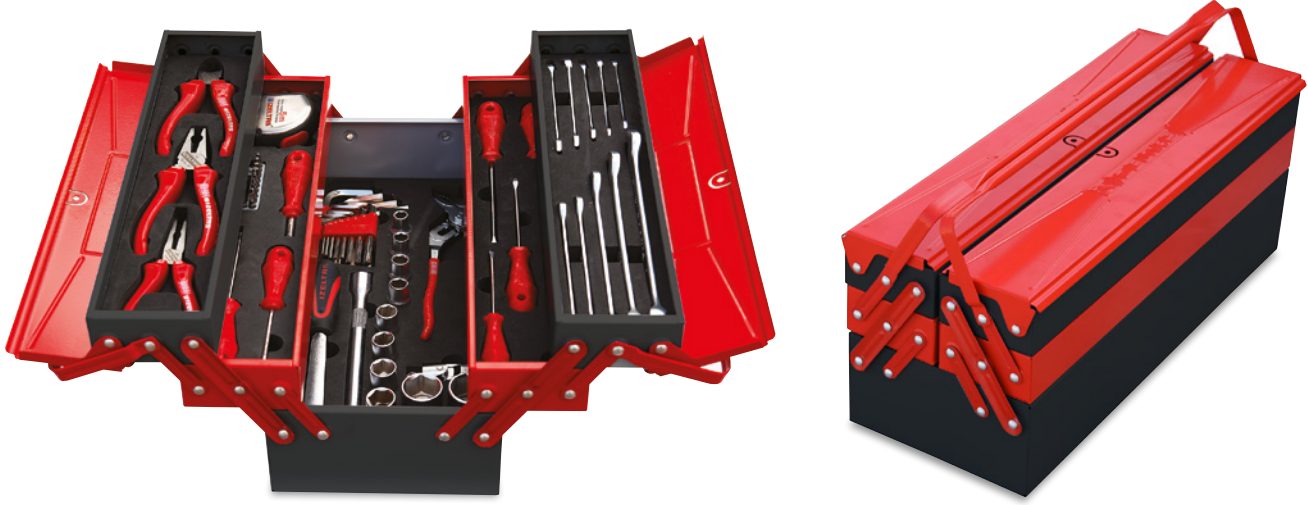

**Takım Çantası (5 Gözlü)**  
**Tool Box (5 Trays)****8420 00 5063**

Mekanikçi Takım Çantası (62 Parça, 5 Gözlü)  
Tool Box for Mechanician (62 Pcs, 5 Trays)

**8420 00 5046**

Elektrikçi Takım Çantası (45 Parça, 5 Gözlü)  
Tool Box for Electrician (45 Pcs, 5 Trays)

**8420 00 5028**

Tesisatçı Takım Çantası (28 Parça, 5 Gözlü)  
Tool Box for Plumbers (28 Pcs, 5 Trays)



## 8420 00 5063

### Mekanikçi Takım Çantası (5 Gözlü) Tool Box for Mechanician (5 Trays)

KOD CODE	ÖLÇÜ SIZE mm	TL/Ad.
8420 00 5063	195x420x210 DOLU / FULL	62 15.815,75

KOD CODE	İÇERİK CONTENTS	
05881 50 015	5 m Krom Şerit Metre Chrom Case Steel, Measuring tapes	1
4785 19 6330	6.3x30 Kısa Bits Tutucu Tornavida Screwdriver, Magnetic Bit Holder (Short)	1
4800 00 8110	10 'Lu Bits Takım Bits Set 10 (Pcs) 25 mm	10
4320	Opak Seri Yıldız Uçlu Tornavida Screwdriver, Opak, Flat 4.5x80-6x100	2
4300	Opak Seri Düz Uçlu Tornavida Screwdriver, Opak, Philips 3x80-4x100-5x125-6x150	4
4550 17 0135	135mm Kontrol Kalem Voltage Tester	1
2400 11 0240	240mm Üniversal Fort Pense Water Pump Pliers Universal	1
1113	1/2" Lokma Anahtar Socket Wrench 10-11-12-13-14-15-17 19-22-24-27-30-32	13
1513 06 4250	1/2" Uzun Ara Kol Extension Bar Long 250 mm	1
1513 06 4070	1/2" Mafsal Universal Joint 70 mm	1
1513 06 0032	1/2" Cırcır Kol 32 Dişli Ratchet Handle 250 mm	1
4900 00 3112	12 'Li Allen Anahtar Takım 6 Köşe Hex Key Wrench Set 2-2.5-3-3.5-4-5-6-7-8-9-10-12	12
0320	Kısa Kombine Anahtar Combination Wrench Short Pattern 8-9-10-11-12-13 14-17-19-22	10
3700 16 2160	160mm Yan Keski Opak Seri Side Cuting Nippers, Opak insulated	1
3020 12 2180	180mm Kombine Pense Opak Seri Combination Pliers, Opak Insulated	1
3220 13 2160	160mm Düz Kargaburun Opak Seri Nose Pliers, Flat, Opak Insulated	1

## 8420 00 5046

### Elektrikçi Takım Çantası (5 Gözlü) Tool Box for Electrician (5 Trays)

KOD CODE	ÖLÇÜ SIZE mm	TL/Ad.
8420 00 5046	195x420x210 DOLU / FULL	45 18.026,50

KOD CODE	İÇERİK CONTENTS	
05881 50 005	5m Plastik Şerit Metre Plastic Measuring Tape	1
4783 19 6120	1000V İzoleli Manyetik Bits Tutucu Tornavida Screwdriver, Magnetic Bit Holder Insulated 6.3x120	1
4800 00 8106	6 'Lı Bits Takım Bits Set (6 Pcs)	6
0600 01 1010	10" Kurbağacık Anahtar Adjustable Jaw Wrench	1
4140-4145	1000V İzoleli Elektrikçi Düz, Yıldız Tornavida Insulated Electrician type Flat Screwdriver, Phillis 1000V 4x100-5.5x125 - 4.5x80-6x100	4
4550 17 0135	135mm Kontrol Kalem Voltage Tester	1
4550 17 0190	190mm Kontrol Kalem Voltage Tester	1
4773	1000V Süngüsü İzoleli Lokma Uçlu Tornavida Nut Spinner, Electrician Blode Insulated 1000V 6-7-8-10-13	5
0340	Cırcır Kombine Anahtar Combination Wrench With Ratchet 8-10-12-13-17-19	6
4900 00 3110	10 'Lu Allen Anahtar Takımı (mm) Hex Key Wrench Set 10 pcs 2-2.5-3-4-5-6-7-8-9-10	10
4500-4520	Klemens Tornavida Screwdriver, Electronic 3x80-3x100-3x125-3x60-4x80	5
3700 16 6160	1000V İzoleli Elektrikçi 160mm Yan Keski Insulated Electrician Type Side Cutter 1000V	1
3020 12 6180	1000V İzoleli Elektrikçi 180mm Kombine Pense Insulated Electrician Type Combination Plier 1000V	1
3220 13 6160	1000V İzoleli Elektrikçi 160mm Kargaburun Düz Insulated Electrician Type Nose Plier 1000V	1

## 8420 00 5028

### Tesisatçı Takım Çantası (5 Gözlü) Tool Box for Plumbers (5 Trays)

KOD CODE	ÖLÇÜ SIZE mm	TL/Ad.
8420 00 5028	195x420x210 DOLU / FULL	28 15.539,75

KOD CODE	İÇERİK CONTENTS	
0600 01 1010	10" Kurbağacık Anahtar 10" Adjustable Wrench	1
0600 01 1012	12" Kurbağacık Anahtar 12" Adjustable Jaw Wrench PVC Insulated	1
2400 11 0240	240 Üniversal Fort Pense 240 Waterpump Pliers, Universal	1
2100 10 0012	12" Stilson Boru Anahtarı 12" Pipe Wrench, Stilson	1
4901 22 1270	1/2" Sae Allen Anahtar 1/2" Hex Key Wrench SAE	1
4300 17 6150	Opak Seri Düz Uçlu Tornavida Screwdriver, Opak, Slotted 6x150	1
4320 18 6100	Opak Seri Yıldız Uçlu Tornavida Screwdriver, Opak, Phillips 6x100	1
5800 25 0500	500gr Çekiç Machinist Hammer	1
5500 23 0200	200mm Düz Keski Flat Cold Chiesel	1
3830 15 0250	250mm Betoncu Kerpeten Tower Pincers	1
4900 00 3112	12 'Li Allen Anahtar Takımı (mm) Hex Key Wrench Set 12 pcs 2-2.5-3-3.5-4-5-6-7-8-9-10-12	12
0588 15 0015	5m Krom Şerit Metre Chrom Case Steel Measuring Tape	1
2201 10 0010	1" Maşalı Boru Anahtarı 1" Pipe Wrench	1
3700 16 2160	160mm Yan Keski Opak Seri Side Cutting Nippers, Opak insulated	1
3020 12 2180	180mm Kombine Pense Opak Seri Combination Pliers, Opak Insulated	1
3220 13 2160	160mm Düz Kargaburun Opak Seri Nose Pliers, Flat, Opak Insulated	1

8440

**Plastik Takım Çantası**  
Plastic Tool Boxes



KOD CODE	inch	ÖLÇÜ SIZE mm	g	TL/Ad.
8440 33 1016	16"	413x212x186	1207	4 780,00
8440 33 1019	19"	480x267x242	1922	4 1.091,00
8440 33 1022	22"	564x310x310	2870	4 1.787,00

8445 33 1028

**Tekerlekli Plastik Takım Çantası**  
Plastic Mobile Tool Chest



KOD CODE	inch	ÖLÇÜ SIZE mm	g	TL/Ad.
8445 33 1028	28"	380x595x420	5900	1 4.304,50

8705 00 6113

**Hobby Set Oto Tipi (13 Parça)**  
Hobby Set Auto Type (13 pcs)



KOD CODE	İÇERİK CONTENTS	TL/Ad.
0100	İki Ağız Anahtar (Kısa Boy) Duble Ended Open Jaw Wrench Short Pattern 8x9-10x11-12x13-14x15-16x17-18x19	6
1841	21 mm Kovan Anahtar Bir Ağız ve Mil Single Ended Tubular Socket Wench	1
2400	240 mm Üiversal Fort Pense Waterpump Pliers Universal	1
3020	160 mm Kombine Pense Opak Seri Combination Pliers	1
4240	Değişken Uçlu Tornavida Takımı Screwdriver Set Reversible 4.5x80 - 6x80	2
5800	200 gr Tesviyeci Çekiç / Machinist Hammer	1
6350	300 mm Levye Oluklu / Tyre Lever Straight	1

8790 00 8106

**Bakım Onarım Seti (5 Parça)**  
Maintenance Set (5 Pcs)



KOD CODE	İÇERİK CONTENTS	TL/Ad.
3020 12 3160	160 mm Kombine Pense Kraft Seri Combination Pliers	1
3220 13 3160	160 mm Kargaburun Düz Uçlu Kraft Seri Nose Pliers Flat	1
3700 16 3140	140 mm Yan Keski Kraft Seri Side Cutting Pliers	1
4100 17 5100	5x100 Kraft Seri Düz Uçlu Tornavida Screwdriver Kraft, Flat	1
4120 18 4580	4.5x80 Kraft Seri Yıldız Uçlu Tornavida Screwdriver Kraft, Phillips	1



**8793 00 1014**
**Bakım Seti (14 Parça)**  
**Maintenance Set (14 Pcs)**

KOD CODE	İÇERİK CONTENTS	☐	TL/Ad.
0100	İki Ağız Anahtar (Kısa Boy) Double Ended Open Jaw Wrench Short Pattern 6x7-8x9-10x11-12x13-14x15-16x17-18x19-20x22	8	
3220 13 2160	160 mm Kargaburun Düz Uçlu Opak Seri Nose Pliers Flat	1	
3700 16 2140	140 mm Yan Keski Opak Seri Side Cutting Pliers	1	3.131,00
4300	4x100-6x100 Opak Seri Düz Uçlu Tornavida Screwdriver Kraft, Flat	2	
4320	4.5x80-6x100 Opak Seri Yıldız Uçlu Tornavida Screwdriver Kraft, Phillips	2	

**8786 00 1003**
**Doğada Set (3 Parça)**  
**Outdoor Set (3 Pcs)**

 İZELTAŞ USTA İŞİ  
 SOHBETLER

KOD CODE	İÇERİK CONTENTS	☐	TL/Ad.
6710 27 0230	Bağ Makası Lüks / Pruning Shears	1	
6735 27 0300	Dal Budama Testeresi / Pruning Saw	1	4.279,25
6410 25 0800	Nacak / Hatchet	1	

**8779 00 8741**
**Motosiklet Bakım Seti (42 Parça)**  
**Biker Set (42 Pcs)**

KOD CODE	İÇERİK CONTENTS	☐	TL/Ad.
0100	İki Ağız Anahtar Kısa Boy Double Ended Open Jaw Wrench Short Pattern 8x9 - 10x11 - 12x13 - 14x15 - 16x17	5	
0600 01 1008	Kurbağacık Anahtar 8" Adjustable Wrench	1	
1107	1/4" Altı Köşe Lokma Anahtar Socket Wrench 6 Point 6 - 8 - 10 - 11 - 12 - 13	6	
1107 06 5010	1/4" Bits Tutucu Lokma Miknatıslı Bit Holder Socket	1	
4240 00 7102	Değişken Uçlu Tornavida Takımı Screwdriver Set Reversible	2	5.356,50
4800 00 8106	6'lı Bits Set (25 mm) Bit Set 6 Pcs	6	
4900 00 3110	Allen Anahtar Takımı 10 Parça Hex Set Wrench Set (10 Pcs)	10	
4910 00 7108	Torx Allen Anahtar Takımı 8 Parça Torx Key Wrench Set (8 Pcs)	8	
1507 06 0050	1/4" Ara Kol 50 mm Extension Bar	1	
1507 06 2140	1/4" Cırcır Kolu 140 mm Ratchet Wrench	1	
1507 06 4080	1/4" Derin Tornavida Adaptörü Spindle Handle	1	

**13000 005376**
**Bisiklet Onarım Seti (3 Parça)**  
**Bike Repair Kit (3 Pcs)**
**YENİ  
NEW**

KOD CODE	İÇERİK CONTENTS	☐	TL/Ad.
	Sele Altı Çanta / Bicycle Seat Bag	1	
13000 005376	Multi Tool	1	1.662,00
	Hediye Zefal Yama Seti / Zefal Bike Patch Kit	1	

# Farkını Gösteren Ustalara.

**IZELTAS**  
**BLACK LINE**

**YENİ  
NEW**



**KOD : 13000 005133**

KOD CODE	İÇERİK CONTENTS	☐	TL/Ad.
13000 005118	Kombine Pense 180 mm Combination Pliers 180 mm	1	4.238,75
13000 005117	Kargaburun Düz Uçlu 180 mm Long Nose Pliers Flat 180 mm	1	
13000 005119	Yan Keski 160 mm Side Cutter 160 mm	1	
13000 005116	Düz Uçlu Tornavida 6x100 Screwdriver Flat 6x100	1	
13000 005120	Yıldız Uçlu Tornavida 6x100 Screwdriver Philips 6x100	1	



8795 00 6005

**1000V İzoleli Elektrikçi Seti (5 Parça)**  
1000V Insulated Tool Set (5 Pcs)



İZELTAS YOUTUBE

KOD CODE	İÇERİK CONTENTS		TL/ Ad.
3020 12 6180	180 mm 1000V İzoleli Elektrikçi Kombine Pense Insulated Electrician Type Combination Pliers 1000V	1	3.810,50
3220 13 6200	200 mm 1000V İzoleli Elektrikçi Kargaburun Insulated Electrician Type Nose Pliers	1	
3700 16 6160	160 mm 1000V İzoleli Elektrikçi Yankeski Insulated Electrician Type Nose	1	
4140 17 5512	5.5x125 1000V Elektrikçi Düz Uçlu Tornavida Insulated Electrician Type Flat Screwdriver 1000V	1	
4145 18 6100	6x100 1000V İzoleli Elektrikçi Yıldız Uçlu Tornavida Insulated Electrician Type Phillips Screwdriver 1000V	1	



8440 00 1023

**19" Plastik Takım Çantası Elektrikçi Set (23 Parça)**  
Plastic Tool Box for Electrician 19" (23 Pcs)



KOD CODE	İÇERİK CONTENTS		TL/ Ad.
8440 33 1019	19" Plastik Takım Çantası Plastic Tool Box	1	8.830,00
3700 16 6160	160 mm 1000V İzoleli Elektrikçi Yan Keski Insulated Electrician Type Side Cutter 1000V	1	
3020 12 6180	180 mm 1000V İzoleli Elektrikçi Kombine Pense Insulated Electrician Type Combination Pliers 1000V	1	
3220 13 6160	160 mm 1000V İzoleli Elektrikçi Kargaburun Düz Uçlu Insulated Electrician Type Nose Pliers 1000V	1	
4773 19 0100	1000V Süngüsü İzoleli Lokma Uçlu Tornavida 10mm Nut Spinner, Electrician Blade Insulated 1000V	1	
4773 19 0130	1000V Süngüsü İzoleli Lokma Uçlu Tornavida 13mm Nut Spinner, Electrician Blade Insulated 1000V	1	
3715 16 6165	165mm 1000V İzoleli Elektrikçi Tek Ağzı Kablo Kesici Cable Cutter 1000V	1	
4520 18 0360	3x60 Klemens Yıldız Tornavida Electronic Screwdriver, Phillips	1	
4520 18 0480	4x80 Klemens Yıldız Tornavida Electronic Screwdriver, Phillips	1	
4500 17 0380	3x80 Klemens Düz Tornavida Electronic Screwdriver, Flat	1	
4500 17 0480	4x80 Klemens Düz Tornavida Electronic Screwdriver, Flat	1	
4140 17 4100	4x100 1000V İzoleli Elektrikçi Düz Tornavida Insulated Electrician Type Flat Screwdriver 1000V	1	
4145 18 4580	4,5x80 1000V İzoleli Elektrikçi Yıldız Tornavida Insulated Electrician Type Phillips Screwdriver 1000V	1	
4145 18 6100	6x100 1000V İzoleli Elektrikçi Yıldız Tornavida Insulated Electrician Type Phillips Screwdriver 1000V	1	
4550 17 0190	190 mm Kontrol Kalem Voltage Tester Flat	1	
4560 18 0190	190 mm Yıldız Kontrol Kalem Voltage Tester Phillips	1	
4783 19 6120	6.3x120 1000V İzoleli Elektrikçi Manyetik Bits Tutucu Tornavida Screwdriver, Magnetic Bit Holder Insulated 1000V	1	
4800 00 8106	6 li Bits Set ( 25 mm ) Bit Set 6 Pcs	6	



**Elektro Takım Çantası (24 Parça)**  
**Electro Tool Bag (24 Pcs)**

KOD CODE	İÇERİK CONTENTS	☐	TL/Ad.
03752 50 625	Kablo Sıyrıcı Cable Stripper	1	
05881 50 005	Plastik Şerit Metre Plastic Steel Case, Measuring tapes	1	
3020 12 6180	1000V İzoleli Elektrikçi Kombine Pense 180mm Insulated Electrician Type Combination Pliers 1000V	1	
3220 13 6180	1000V İzoleli Elektrikçi Kargaburun Düz Uçlu 180mm Insulated Electrician Type Nose Pliers 1000V	1	
3700 16 6160	1000V İzoleli Elektrikçi Yan Keski 160mm Insulated Electrician Type Side Cutter 1000V	1	
4140	1000V İzoleli Elektrikçi Düz Uçlu Tornavida Insulated Electrician Type Flat Screwdriver 1000V 2.5x75 - 4x100 - 5.5x125	3	22.152,75
4145	1000V İzoleli Elektrikçi Yıldız Uçlu Tornavida Insulated Electrician Type Phillips Screwdriver 1000V 3x60 - 4.5x80 - 6x100	3	
4550 17 0190	Elektrik Kontrol Kalem 190mm (Düz Uçlu) Voltage Tester (Flat)	1	
13000 005263	1000V 1/2" Altı Köşe Lokma Anahtar (mm) Socket Wrench 6 Points 1000V (mm) 10 - 11 - 12 - 13 - 14 - 15 - 16 - 17 - 19	9	
13000 005277	1000V Ara Kol 125mm Extension Bar 1000V	1	
	1000V 1/2" Cırcır Kolu (32 Diş) Ratchet Handle 1000V (32 Teeth)	1	

**14000 004136**
**Sırt Takım Çantası**  
**Tool Backpack**

**Sırt Takım Çantası**

- Su geçirmez, sağlam, dayanıklı ve uzun ömürlü, 600x600 imperteks kumaş
- Koruma sağlayıcı güçlendirilmiş sağlam plastik taban
- Maksimum düzeni sağlayan reflektörlü ön ve iç cepler
- Laptop bölmesi, sık kullanılan el aletleri için cepli çıkarılabilir ayraç
- Yumuşak pedli sırt desteği
- Yan mataralıklar

**Tool Backpack**

- Waterproof, solid, resistant and long-lasting 600X600 impertex fabric
- Protection provider, reinforced, solid plastic base
- Reflective front and interior pockets for maximum organization
- Laptop compartment, removable divider with pockets for frequently used tools
- Back support with soft pad
- Side bottle pockets

**Bu çanta boş olarak satılmaktadır**  
**This backpack is sold empty**

KOD/CODE	Ölçü / SIZE (mm)	g	☐	TL/Ad.
14000 004136	700x280x450	1385	1	2.723,00

14000 005148

Pro Sirt Takım Çantası  
Pro Tool Backpack



**Pro Sirt Takım Çantası**

- Su geçirmez, sağlam, dayanıklı ve uzun ömürlü, 600x600 imperteks kumaş
- Koruma sağlayıcı güçlendirilmiş sağlam plastik taban
- Maksimum düzeni sağlayan reflektörlü fermuarlı cepler
- Laptop bölmesi, sık kullanılan el aletleri için cepli çıkarılabilir ayraç
- Yumuşak pedli sirt desteği
- Yan cepler



**Pro Tool Backpack**

- Waterproof, solid, resistant and long-lasting 600X600 impertex fabric
- Protection provider, reinforced, solid plastic base
- Reflective front and interior zip pockets for maximum organization
- Laptop compartment, removable divider with pockets for frequently used tools
- Back support with soft pad
- Side pockets

Bu çanta boş olarak satılmaktadır  
This backpack is sold empty

KOD/CODE	Ölçü / SIZE (mm)	g	1	TL/Ad.
14000 005148	250x350x480	1220	1	4.561,25



14000 004133

**Büyük Boy Bez Takım Çantası**  
Large Tool Bag**Büyük Boy Bez Takım Çantası**

- Su geçirmez, sağlam, dayanıklı ve uzun ömürlü, 600x600 imperteks kumaş
- Koruma sağlayıcı güçlendirilmiş sağlam plastik taban
- Maksimum düzeni sağlayan reflektörlü ön cepler, çoklu arka ve iç cepler
- Özel el aleti bölmeli, geniş iç alan
- Ayarlanabilir omuz askısı ile kolay taşıma

**Large Tool Bag**

- Waterproof, solid, resistant and long-lasting 600X600 impertex fabric
- Protection provider, reinforced, solid plastic base
- Reflective front pockets with multiple back and interior pockets for maximum organization
- Wide interior space with special tool compartment
- Easy carrying with asjustable shoulder strap

Bu çanta boş olarak satılmaktadır  
This toolbag is sold empty

KOD/CODE	Ölçü / SIZE (mm)	g	TL/Ad.
14000 004133	250x350x480	1220	1 2.486,50

14000 004135

**Orta Boy Bez Takım Çantası**  
Medium Tool Bag**Orta Boy Bez Takım Çantası**

- Su geçirmez, sağlam, dayanıklı ve uzun ömürlü, 600x600 imperteks kumaş
- Koruma sağlayıcı güçlendirilmiş sağlam plastik taban
- Maksimum düzeni sağlayan reflektörlü ön cepler, çoklu arka ve iç cepler
- Özel el aleti bölmeli, geniş iç alan
- Ayarlanabilir omuz askısı ile kolay taşıma

**Medium Tool Bag**

- Waterproof, solid, resistant and long-lasting 600X600 impertex fabric
- Protection provider, reinforced, solid plastic base
- Reflective front pockets with multiple back and interior pockets for maximum organization
- Wide interior space with special tool compartment
- Easy carrying with asjustable shoulder strap

Bu çanta boş olarak satılmaktadır  
This toolbag is sold empty

KOD/CODE	Ölçü / SIZE (mm)	g	TL/Ad.
14000 004135	290x230x360	870	1 2.370,00



14000 004134

### Küçük Boy Bez Takım Çantası Small Tool Bag



### Küçük Boy Bez Takım Çantası

- Su geçirmez, sağlam, dayanıklı ve uzun ömürlü, 600x600 imperteks kumaş
- Kuvvetlendirilmiş taban
- Fermuarlı fileli ön cep
- Düğmeli arka cep
- Özel el aleti bölmeli, geniş iç alan
- Rahat taşıma için deri elcik
- Yan reflektörler
- Özel metal fermuar başlığı

### Small Tool Bag

- Waterproof, solid, resistant and long-lasting 600X600 impertex fabric
- Reinforced base
- Zippered front pocket
- Buttoned back pocket
- Wide interior space with special tool compartment
- Leather grips for comfortable carrying
- Side reflectors

Bu çanta boş olarak satılmaktadır  
This toolbag is sold empty

KOD/CODE	Ölçü / SIZE (mm)	g	TL/Ad.
14000 004134	120x230x300	390	1 1.537,25

14000 004137

### Bel Takım Çantası Handyman Tool Belt



### Bel Takım Çantası

- Su geçirmez, sağlam, dayanıklı ve uzun ömürlü, 600x600 imperteks kumaş
- 3 farklı boyda cebi ve 8 el aleti askısı ile maksimum düzeni sağlayan kullanışlı model
- Reflektörlü ön cep
- Ayarlanabilir ve kullanışlı sağlam kemer

### Handyman Tool Belt

- Waterproof, solid, resistant and long-lasting 600X600 impertex fabric
- Maximum organization providing functional model with 3 different sized pockets and 8 tool hangers
- Reflective front pocket
- Adjustable and functional solid belt

Bu çanta boş olarak satılmaktadır  
This tool belt is sold empty

KOD/CODE	Ölçü / SIZE (mm)	g	TL/Ad.
14000 004137	424x594x851	290	1 930,00

**ŞABLON  
BILLET**



**FİNAL ÜRÜN  
FINAL PRODUCT**



# ANAHTARLAR

## WRENCHES

- İki Ağız Anahtarlar  
Open Jaw Wrenches
- Kombine Anahtarlar  
Combination Wrenches
- Yıldız Anahtarlar  
Ring Wrenches
- Çakma Anahtarlar  
Slugging Wrenches
- Kurbağacık Anahtarlar  
Adjustable Wrenches





## İKİ AĞIZ ANAHTAR / DOUBLE ENDED OPEN JAW WRENCH

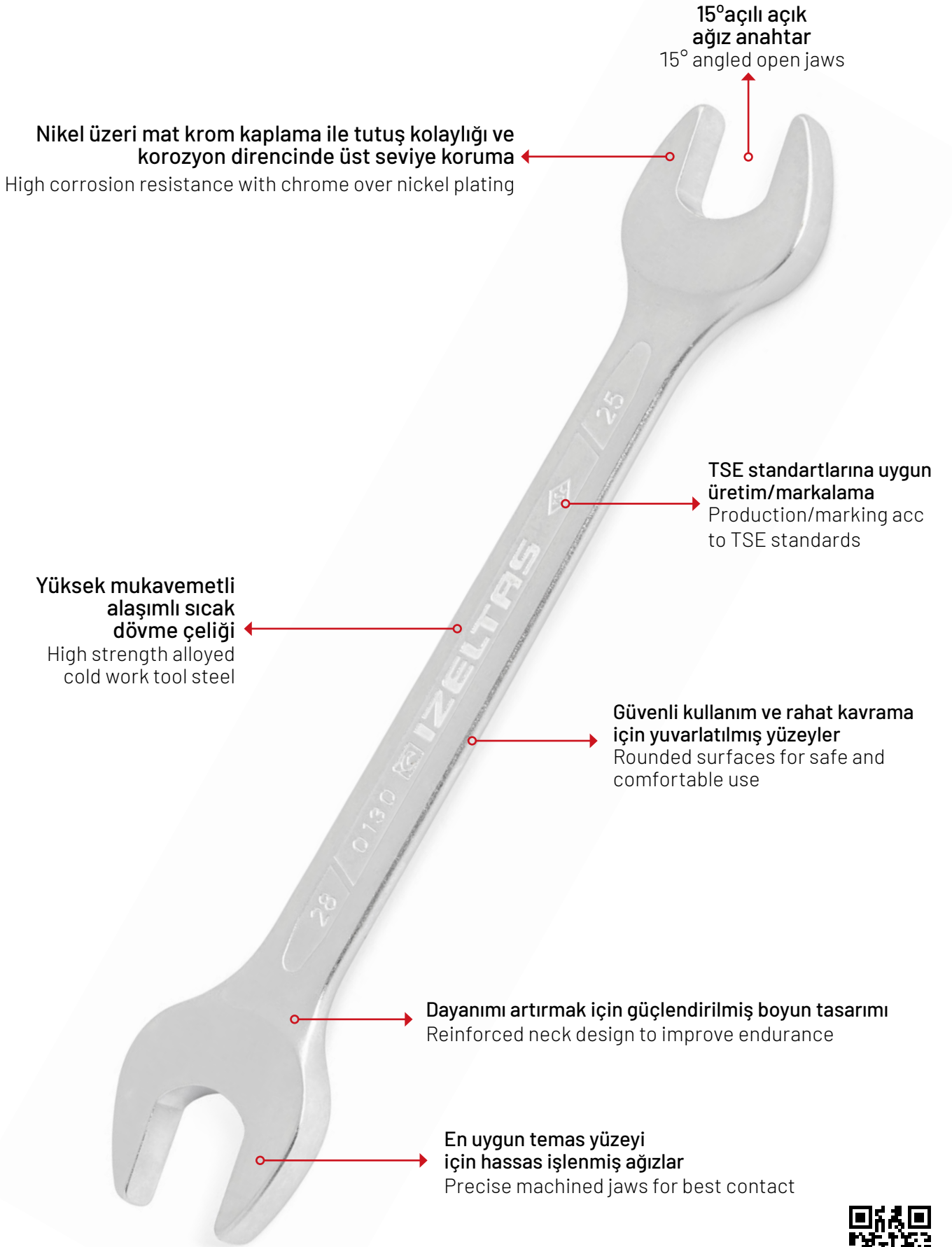

15° açılı açık  
ağız anahtar  
15° angled open jaws

Nikel üzeri mat krom kaplama ile tutuş kolaylığı ve  
korozyon direncinde üst seviye koruma  
High corrosion resistance with chrome over nickel plating

TSE standartlarına uygun  
üretim/markalama  
Production/marking acc  
to TSE standards

Yüksek mukavemetli  
alaşımli sıcak  
dövme çeliği  
High strength alloyed  
cold work tool steel

Güvenli kullanım ve rahat kavrama  
için yuvarlatılmış yüzeyler  
Rounded surfaces for safe and  
comfortable use

Dayanımı artırmak için güçlendirilmiş boyun tasarımı  
Reinforced neck design to improve endurance

En uygun temas yüzeyi  
için hassas işlenmiş ağızlar  
Precise machined jaws for best contact



İZELTAS YOUTUBE

**İki Ağız Anahtar Kısa Boy (mm)**

Double Ended Open Jaw Wrench Short Pattern (mm)



TS 81

DIN 895

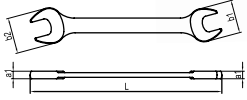

İZELTAS YOUTUBE

 Krom vanadyum, Krom kaplı  
 Chrom vanadium, Chrom plated

KOD CODE	mm	L mm	a1 mm	b1 mm	b2 mm	g	TL/ Ad.	
0100 01 0405	4x5	97	3.5	11	12.5	15	10	90,00
0100 01 0607	6x7	97	3.5	14	16	18	10	92,50
0100 01 0809	8x9	108	4	18	20	30	10	95,00
0100 01 0810	8x10	117	4.5	18	22	33	10	104,50
0100 01 1011	10x11	120	4.6	22	24	41	10	103,25
0100 01 1012	10x12	120	4.6	22	26	35	10	103,25
0100 01 1013	10x13	120	4.6	22	28	38	10	110,50
0100 01 1213	12x13	133	5.2	26	28	57	10	114,00
0100 01 1214	12x14	147	5.2	26	30	59	10	114,00
0100 01 1314	13x14	147	5.2	28	30	66	10	114,00
0100 01 1415	14x15	147	5.8	30	32	78	10	131,00
0100 01 1317	13x17	162	6.2	28	36	80	10	149,00
0100 01 1417	14x17	162	6.2	30	36	90	10	152,50
0100 01 1617	16x17	162	6.2	34	36	109	10	152,50
0100 01 1719	17x19	178	7	36	40	143	10	164,50
0100 01 1819	18x19	178	7	38	40	144	10	164,50
0100 01 1922	19x22	195	7.4	40	46	175	10	185,00
0100 01 2022	20x22	195	7.4	42	46	196	10	191,00
0100 01 2123	21x23	213	7.7	44	48	230	10	200,50
0100 01 2224	22x24	213	8	46	50	239	10	209,00
0100 01 2426	24x26	232	8.2	50	54	297	10	215,00
0100 01 2427	24x27	232	8.2	50	56	296	10	215,00
0100 01 2528	25x28	248	8.6	52	57.5	366	10	266,50
0100 01 2732	27x32	265	9	56	66	415	10	318,00
0100 01 3032	30x32	265	9	62	66	465	10	318,00

**ÖZEL SERİLER (adet ve termin süresi isteyiniz)  
 SPECIAL SERIES (ask for quantity and delivery terms)**

0100 01 0608	6x8	97	3.5	14	18	20	10	-
0100 01 0708	7x8	108	3.5	16	18	20	10	-
0100 01 0709	7x9	108	4	16	20	25	10	-
0100 01 0910	9x10	117	4.6	20	22	30	10	-
0100 01 0911	9x11	120	4.6	20	24	30	10	-
0100 01 1014	10x14	120	5.2	22	30	50	10	-
0100 01 1113	11x13	133	5.2	26	28	50	10	-
0100 01 1114	11x14	133	5.2	26	28	50	10	-
0100 01 1315	13x15	147	5.2	28	30	65	10	-
0100 01 1722	17x22	195	7.4	36	46	160	10	-
0100 01 1820	18x20	178	7	38	40	125	10	-
0100 01 1822	18x22	195	7.4	40	46	160	10	-
0100 01 1924	19x24	213	7.7	40	50	200	10	-
0100 01 2226	22x26	232	8	46	54	250	10	-
0100 01 2227	22x27	232	8.2	46	56	260	10	-
0100 01 2430	24x30	265	9	50	62	370	10	-
0100 01 2730	27x30	265	9	56	62	380	10	-

**0100**
**İki Ağız Anahtar Takımı Kısa Boy (mm)  
 Double Ended Open Jaw Wrench  
 Short Pattern Set (mm)**

KOD CODE	İÇERİK CONTENTS	g	TL/ Ad.	
0100 00 2108	6x7 - 8x9 - 10x11 12x13 - 14x15 - 16x17 18x19 - 20x22	736	8	1.043,75
0100 00 2112	6x7 - 8x9 - 10x11 12x13 - 14x15 - 16x17 18x19 - 20x22 - 21x23 24x26 - 25x28 - 30x32	2110	12	2.043,75

**İki Ağız Anahtar Uzun Boy (mm)**

Double Ended Open Jaw Wrench Long Pattern (mm)

  
 TS ISO 10102  
 DIN 3110

 Krom vanadyum, Krom kaplı  
 Chrom vanadium, Chrom plated

KOD CODE	mm	L mm	a1 mm	b1 mm	b2 mm	g	TL/Ad.	
0130 01 0607	6x7	125	3.5	14	16	24	10	117,75
0130 01 0608	6x8	125	3.5	14	18	20	10	121,25
0130 01 0809	8x9	140	4	18	20	35	10	121,25
0130 01 0810	8x10	140	4	18	22	36	10	121,25
0130 01 1011	10x11	155	4.5	22	24	47	10	134,50
0130 01 1012	10x12	162	4.7	22	26	57	10	134,50
0130 01 1013	10x13	162	4.7	22	28	61	10	134,50
0130 01 1014	10x14	162	4.7	22	28	65	10	134,50
0130 01 1113	11x13	172	5	26	28	70	10	134,50
0130 01 1114	11x14	172	5	26	30	65	10	134,50
0130 01 1213	12x13	172	5	26	28	67	10	141,75
0130 01 1214	12x14	172	5	26	30	65	10	141,75
0130 01 1314	13x14	188	5.5	28	30	85	10	141,75
0130 01 1315	13x15	188	5.5	30	32	93	10	141,75
0130 01 1415	14x15	188	5.5	30	32	91	10	164,50
0130 01 1317	13x17	205	6.2	28	36	111	10	179,00
0130 01 1417	14x17	205	6.2	30	36	106	10	179,00
0130 01 1617	16x17	205	6.2	34	36	120	10	181,25
0130 01 1618	16x18	220	7	36	40	165	10	193,25
0130 01 1719	17x19	220	7	36	40	160	10	193,25
0130 01 1819	18x19	220	7	38	40	161	10	193,25
0130 01 1921	19x21	235	7.5	40	46	195	5	224,50
0130 01 1922	19x22	235	7.5	40	46	195	5	224,50
0130 01 2022	20x22	235	7.5	42	46	195	5	224,50
0130 01 1924	19x24	248	8.3	40	50	235	5	225,75
0130 01 2123	21x23	248	8.3	44	48	235	5	229,25
0130 01 2224	22x24	248	8.3	46	50	235	5	243,75
0130 01 2426	24x26	265	8.8	50	54	300	5	278,50
0130 01 2427	24x27	265	8.8	50	56	300	5	278,50
0130 01 2430	24x30	282	9.3	50	61.5	380	5	311,00
0130 01 2528	25x28	282	9.3	52	57.5	390	5	311,00
0130 01 2729	27x29	300	9.8	56	59	400	5	387,75
0130 01 2730	27x30	300	9.8	56	59	440	5	387,75
0130 01 2732	27x32	300	9.8	56	65.5	460	5	387,75
0130 01 3032	30x32	300	9.8	61.5	65.5	480	5	387,75
0130 01 3036	30x36	325	10.4	61.5	76	645	5	734,50
0130 01 3236	32x36	325	10.4	65.5	76	680	5	734,50
0130 01 3436	34x36	330	10.4	71	76	690	5	734,50
0130 01 3641	36x41	360	12	76	87	955	5	1.141,25
0130 01 4146	41x46	400	12.5	87	98	1300	5	1.758,00
0130 01 4650	46x50	450	13	98	107	1635	5	1.950,00

**ÖZEL SERİLER (adet ve termin süresi isteyiniz)**
**SPECIAL SERIES (ask for quantity and delivery terms)**

0130 01 0555	5x5.5	125	3.5	14	16	15	10	-
0130 01 0708	7x8	135	3.5	16	18	20	10	-
0130 01 0709	7x9	140	4	16	20	30	10	-
0130 01 0910	9x10	140	4	18	22	45	10	-
0130 01 0911	9x11	155	4.5	22	24	45	10	-
0130 01 1722	17x22	235	7.5	36	46	190	5	-
0130 01 1724	17x24	248	8.3	36	50	240	5	-
0130 01 2227	22x27	265	8.8	46	56	300	5	-

**0130**
**İki Ağız Anahtar Takımı Uzun Boy (mm)**

 Double Ended Open Jaw Wrench  
 Long Pattern Set (mm)



KOD CODE	İÇERİK CONTENTS	g	TL/Ad.	
0130 00 2108	6x7 - 8x9 - 10x11 - 12x13 14x15 - 16x17 - 18x19 20x22	815	8	1.278,75
0130 00 2112	6x7 - 8x9 - 10x11 12x13 - 14x15 - 16x17 18x19 20x22 - 21x23 24x26 - 25x28 - 27x32	2315	12	2.485,25



0161

**İki Ağız Anahtar Uzun Boy (SAE)**  
Double Ended Open Jaw Wrench Long Pattern (SAE)

TSEK



Krom vanadyum, Krom kaplı  
Chrom vanadium, Chrom plated

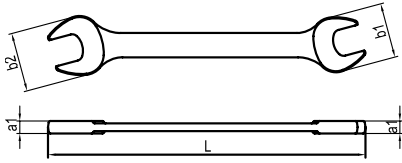

0161

**İki Ağız Anahtar Takımı Uzun Boy (SAE)**  
Double Ended Open Jaw Wrench  
Long Pattern Set (SAE)

TSEK

KOD CODE	inch	L mm	a1 mm	b1 mm	b2 mm	g	TL/ Ad.	
0161 01 0608	1/4"x5/16"	125	3.5	14	18	18	10	145,25
0161 01 0809	5/16"x3/8"	140	4	18	20	30	10	145,25
0161 01 0810	5/16"x11/32"	140	4	18	20	30	10	145,25
0161 01 0811	5/16"x7/16"	140	4	18	22	30	10	145,25
0161 01 0911	3/8"x7/16"	155	4.5	22	24	35	10	161,00
0161 01 1112	7/16"x1/2"	172	5	26	28	40	10	161,00
0161 01 1214	1/2"x9/16"	172	5	26	30	65	10	169,25
0161 01 1416	9/16"x5/8"	188	5.5	30	32	85	10	197,00
0161 01 1417	9/16"x11/16"	205	6.2	30	36	110	10	213,75
0161 01 1517	19/32"x11/16"	205	6.2	34	36	115	10	216,00
0161 01 1619	5/8"x3/4"	220	7	36	40	150	10	231,75
0161 01 1920	3/4"x25/32"	220	7	38	40	160	10	231,75
0161 01 2021	25/32"x13/16"	235	7.5	40	46	195	10	269,00
0161 01 1922	3/4"x7/8"	235	7.5	40	46	195	10	269,00
0161 01 2122	13/16"x7/8"	248	8.3	44	48	235	10	273,75
0161 01 2325	15/16"x1"	265	8.8	50	54	300	10	323,00
0161 01 2328	15/16"x1 1/8"	265	8.8	50	56	300	10	326,50
0161 01 2628	1 1/16"x1 1/8"	300	9.8	56	59.5	460	10	468,00
0161 01 2631	1 1/16"x1 1/4"	300	9.8	56	65.5	460	10	494,50
0161 01 2833	1 1/8"x1 5/16"	300	9.8	56	65.5	460	10	494,50



KOD CODE	İÇERİK CONTENTS	g	TL/ Ad.	
0161 00 2108	1/4"x5/16" - 5/16"x3/8" 7/16"x1/2" - 9/16"x5/8"-19/32"x11/16" 3/4"x25/32" - 13/16"x7/8"-15/16"x1"	1090	8	1.693,00
0161 00 2112	1/4"x5/16" - 5/16"x3/8" - 3/8"x7/16" 7/16"x1/2" - 1/2"x9/16" - 9/16"x5/8" 19/32"x11/16" - 3/4"x25/32" - 13/16"x7/8" 15/16"x1" - 1 1/16"x1 1/4" 1 1/8"x1 5/16"	2165	12	3.012,25

**Bir Ağız Taçlı Anahtar (mm)**  
 Single Ended Open Jaw Wrench (mm)

TS 81

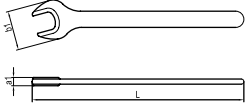
**Krom vanadyum**  
 Chrom vanadium

KOD CODE	mm	L mm	a1 mm	b1 mm	g	TL/Ad.
0250 01 0030	30	260	10.5	60	250	1 536,50
0250 01 0036	36	300	10.5	74.5	370	1 677,00
0250 01 0041	41	345	12.2	85.5	550	1 882,00
0250 01 0046	46	390	14	96.5	750	1 949,25
0250 01 0050	50	423	15.2	105	1000	1 1.185,75
0250 01 0055	55	455	16.5	113.5	1300	1 1.587,75
0250 01 0060	60	490	17.6	121	1600	1 2.033,00
0250 01 0065	65	524	19	130	1980	1 2.477,00

**ÖZEL SERİLER (adet ve termin süresi isteyiniz)**  
**SPECIAL SERIES (ask for quantity and delivery terms)**

0250 01 0021	21	185	8	42.4	95	1 -
0250 01 0022	22	195	8	44.4	110	1 -
0250 01 0023	23	195	8	46.3	115	1 -
0250 01 0024	24	215	9	48.3	150	1 -
0250 01 0025	25	215	9	50.3	155	1 -
0250 01 0027	27	240	9.5	54.3	200	1 -
0250 01 0032	32	274	11	63	300	1 -
0250 01 0034	34	274	11	68	320	1 -
0250 01 0038	38	300	10.5	76.8	400	1 -
0250 01 0070	70	564	20.8	140	2480	1 -
0250 01 0075	75	608	21.8	151	3100	1 -

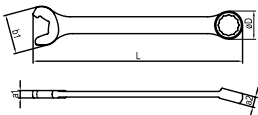
**Montaj Anahtar (mm)**  
 Speed Wrench (mm)

**Krom vanadyum, Krom kaplı**  
 Chrom vanadium, Chrom plated

KOD CODE	mm	L mm	a1 mm	a2 mm	b1 mm	øD mm	g	TL/Ad.
0325 02 0010	10	135	4.3	6.9	22	15.5	35	10 206,50
0325 02 0013	13	165	5.2	7.9	28	19.5	45	10 230,50
0325 02 0017	17	205	6.4	9.8	36	25.5	110	10 305,00
0325 02 0019	19	225	7	11	40	28.5	155	10 356,50
0325 02 0020	20	230	7.2	11.4	42	30	180	10 362,50
0325 02 0021	21	242	7.4	12	44	31.5	180	10 421,25
0325 02 0022	22	250	8.2	12.6	46	33	245	10 482,50

**Süper İzole Çatal Bir Ağız Anahtar (mm)**  
 Single Ended Open Jaw Wrench Super Insulated (mm)

 △ 1000 V  
 IEC 60900

**Krom vanadyum, Krom kaplı, Kalın PVC izoleli**  
 Chrom vanadium, Chrom plated, Triple PVC insulated

KOD CODE	mm	L mm	g	TL/Ad.
0255 01 0010	10	110	40	10 313,25
0255 01 0011	11	120	45	10 331,25
0255 01 0012	12	130	50	10 347,00
0255 01 0013	13	140	60	10 373,25
0255 01 0014	14	155	75	10 386,50
0255 01 0017	17	170	100	10 474,00
0255 01 0019	19	185	150	10 555,75
0255 01 0022	22	200	200	10 747,75
0255 01 0024	24	220	280	10 914,50



IZELTAS YOUTUBE

**%100 Daha Hızlı**

Yeni tasarlanan montaj anahtarı, 2 kat hızlınciricir mekanizması mantığına dayanan çalışma prensibinden alır. Kullanım sırasında, montaj anahtarını civatadan ayırmadan döndürme kolaylığı kullanım hızını artırırken, civata köşelerine sağlam tutunan anahtar profili güvenli ve kaydırmaz kullanım sağlar.

**Uzun Ömür**

Bu yeni montaj anahtar profili, civata ve somunlar ile köşelerinden değil düz yüzeyleri üzerinden temas ederek düzenli tork iletimini sağlarken, gerilimin artmasını da engelleyerek anahtar ömrünün uzamasını sağlar.

- Anahtarı civatadan ayırmadan hızlı kullanım.
- Güvenli tork iletimi ve uzun ömür.

**100% Faster**

The 100% new design speed wrench takes the 2-fold speed from the operating principle based on the ratchet mechanism logic. While in use, the ease of rotation without detaching the mounting wrench from the bolt increases the speed of use and the profile that firmly secured to the corners ensures safe and non-slip use

**Long Life**

This new mounting wrench profile by contacting bolts and nuts, not on corners, but on their flat surfaces, allows regular torx transmission, prevents the increase in surface tension and provides longer life.

- Quick use without detaching the wrench from the bolt.
- Safe torx transmission and long

**Kombine Anahtar Kısa Boy (mm)**  
 Combination Wrench Short Pattern (mm)

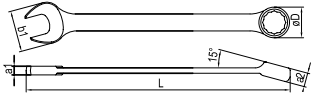
 TS 3794  
 TS ISO 7738 Form A  
 DIN 3113

 Krom vanadyum, Krom kaplı  
 Chrom vanadium, Chrom plated

**0320**
**Kombine Anahtar Takımı Kısa Boy (mm)**  
 Combination Wrench Short Pattern Set (mm)



KOD CODE	mm	L mm	a1 mm	a2 mm	b1 mm	øD mm	g	TL/ Ad.	
0320 02 0005	5	90	3.4	5.1	14	10	15	10	117,75
0320 02 0055	5.5	90	3.4	5.1	14	10	15	10	117,75
0320 02 0006	6	100	3.4	5.1	14	10	15	10	121,25
0320 02 0007	7	110	3.6	5.5	16	11	20	10	129,75
0320 02 0008	8	120	3.8	5.9	18	13	25	10	140,50
0320 02 0009	9	130	4	6.3	20	14	30	10	144,00
0320 02 0010	10	140	4.3	6.9	22	15.5	40	10	162,00
0320 02 0011	11	150	4.5	7.3	24	17	45	10	165,75
0320 02 0012	12	160	4.9	7.7	26	18.5	55	10	177,75
0320 02 0013	13	170	5.2	7.9	28	19.5	60	10	181,25
0320 02 0014	14	180	5.5	8.7	30	21.5	75	10	195,75
0320 02 0015	15	190	5.8	9.1	32	22.5	90	10	209,00
0320 02 0016	16	200	6.1	9.6	34	24	105	10	224,50
0320 02 0017	17	210	6.4	9.8	36	25.5	120	10	240,00
0320 02 0018	18	220	6.8	10.4	38	27	145	10	266,50
0320 02 0019	19	232	7	11	40	28.5	170	10	281,00
0320 02 0020	20	240	7.2	11.4	42	30	195	10	285,75
0320 02 0021	21	250	7.4	12	44	31.5	190	10	331,25
0320 02 0022	22	260	8.2	12.6	46	33	275	10	378,00
0320 02 0023	23	270	8.3	13	48	35	255	5	378,00
0320 02 0024	24	280	8.5	13.6	50	36.5	320	5	463,25
0320 02 0025	25	290	8.8	14	52	39	320	5	463,25
0320 02 0026	26	300	9	14.8	54	41	400	5	545,00
0320 02 0027	27	310	9.3	15	56	41.5	400	5	545,00
0320 02 0028	28	320	9.4	15.4	57.5	42.5	380	5	545,00
0320 02 0029	29	330	10	15.6	59	43.5	510	5	624,00
0320 02 0030	30	340	10.3	16	61.5	44	505	5	624,00
0320 02 0032	32	370	10.5	16.2	65.5	47	560	5	655,25
0320 02 0034	34	400	10.7	16.8	71	50	675	5	685,25



KOD CODE	İÇERİK CONTENTS	g	TL/ Ad.	
0320 00 2108	6 - 7 - 8 - 9 - 10 - 13 - 17 - 19	475	8	1.399,75
0320 00 2112	8 - 9 - 10 - 11 - 12 - 13 - 14 15 - 16 - 17 - 19 - 22	1190	12	2.499,50
0320 00 2117	6 - 7 - 8 - 9 - 10 - 11 - 12 - 13 - 14 15 - 16 - 17 - 18 - 19 - 20 - 21 - 22	1760	17	3.634,00
0320 00 2121	6 - 7 - 8 - 9 - 10 - 11 - 12 - 13 - 14 15 - 16 - 17 - 18 - 19 - 20 - 21 - 22 24 - 27 - 30 - 32	3650	21	5.921,50

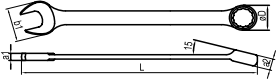

**Kombine Anahtar Uzun Boy (mm)**  
**Combination Wrench, Long Pattern (mm)**

 TS 3794  
 TS ISO 7738 Form A  
 DIN 3113

**Krom vanadyum, Krom kaplı**  
**Chrom vanadium, Chrom plated**

KOD CODE	mm	L	a1 mm	a2 mm	b1 mm	øD mm	g	TL/Ad.
0330 02 0005	5	95	3.2	5.2	12.5	9	20	135,75
0330 02 0055	5.5	95	3.2	5.2	12.5	9	20	135,75
0330 02 0006	6	105	3.8	5.6	14	10.5	20	135,75
0330 02 0007	7	117	4	6.1	16	12	20	135,75
0330 02 0008	8	130	4.2	6.6	18	13.5	30	158,50
0330 02 0009	9	141	4.5	7	20	15	40	161,00
0330 02 0010	10	154	4.7	7.6	22	16	50	177,75
0330 02 0011	11	166	5	8.2	24	17.5	60	187,25
0330 02 0012	12	178	5.2	8.7	26	19	70	187,25
0330 02 0013	13	190	5.6	9.2	28	20.5	80	210,00
0330 02 0014	14	203	5.8	9.7	30	22	100	218,50
0330 02 0015	15	215	6.4	10.1	32	23.5	115	233,00
0330 02 0016	16	227	6.4	10.8	34	25	135	235,25
0330 02 0017	17	239	6.6	11.4	36	26.5	160	266,50
0330 02 0018	18	250	7	12	38	28	186	288,00
0330 02 0019	19	263	7.3	12.7	40	29.5	205	313,25
0330 02 0020	20	275	7.7	13.2	42	31	235	332,50
0330 02 0021	21	288	8.1	13.3	44	31.5	260	354,00
0330 02 0022	22	300	8.5	13.7	46	34	300	421,25
0330 02 0023	23	315	8.8	14.2	48	35.5	300	512,50
0330 02 0024	24	330	9	14.2	50	37	390	512,50
0330 02 0025	25	340	9.3	14.7	52	38.5	380	512,50
0330 02 0026	26	350	9.7	14.7	54	40	475	603,75
0330 02 0027	27	360	10	15.2	56	41	475	603,75
0330 02 0028	28	370	10.4	15.7	57.5	43	475	603,75
0330 02 0029	29	390	10.8	16.2	59	44	610	603,75
0330 02 0030	30	410	11.2	16.6	61.5	45	610	693,75
0330 02 0032	32	420	11.5	17.1	65.5	48	755	727,25
0330 02 0034	34	430	11.8	17.4	71	50.5	735	741,75
0330 02 0036	36	440	12.2	17.7	76	53	1000	840,00
0330 02 0038	38	450	12.5	18.7	80	56	1000	859,25
0330 02 0041	41	480	13.5	19.7	87	61	1240	978,00
0330 02 0046	46	505	14.7	20.7	95	67.5	1635	1.328,50
0330 02 0050	50	540	15.9	22.7	104	73.5	2100	1.800,00

**0330**
**Kombine Anahtar Takımı Uzun Boy (mm)**  
**Combination Wrench Long Pattern Set (mm)**

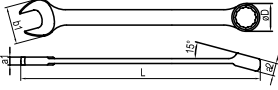
KOD CODE	İÇERİK CONTENTS	g	TL/Ad.
0330 00 2108	6 - 7 - 8 - 9 - 10 - 13 17 - 19	665	8
0330 00 2112	8 - 9 - 10 - 11 - 12 13 - 14 - 15 - 16 17 - 19 - 22	1780	12
0330 00 2117	6 - 7 - 8 - 9 - 10 11 - 12 - 13 - 14 - 15 16 - 17 - 18 - 19 20 - 21 - 22	2170	17
0330 00 2121	6 - 7 - 8 - 9 - 10 - 11 12 - 13 - 14 - 15 - 16 17 - 18 - 19 - 20 - 21 22 - 24 - 27 - 30 - 32	4465	21

**Kombine Anahtar Uzun Boy (SAE)**  
**Combination Wrench Long Pattern (SAE)**
**TSEK**

**Krom vanadyum, Krom kaplı**  
**Chrom vanadium, Chrom plated**
**0331**
**Kombine Anahtar Takımı Uzun Boy (SAE)**  
**Combination Wrench Long Pattern Set (SAE)**

KOD CODE	inch	L mm	a1 mm	a2	b1 mm	ρD mm	g	TL/ Ad.	
0331 02 0005	3/16"	95	3.2	5.2	12.5	9	15	10	162,00
0331 02 0006	1/4"	105	3.8	5.6	14	10.5	20	10	169,25
0331 02 0008	5/16"	130	4.2	6.6	18	13.5	30	10	195,75
0331 02 0010	3/8"	154	4.7	7.6	22	16	50	10	223,25
0331 02 0011	7/16"	166	5	8.2	24	17.5	60	10	235,25
0331 02 0013	1/2"	190	5.6	9.2	28	20.5	80	10	264,00
0331 02 0014	9/16"	203	5.8	9.7	30	22	100	10	277,25
0331 02 0015	19/32"	215	6.4	10.1	32	23.5	115	10	294,00
0331 02 0016	5/8"	227	6.4	10.8	34	25	135	10	315,75
0331 02 0017	11/16"	239	6.6	11.4	36	26.5	155	10	337,25
0331 02 0019	3/4"	263	7.3	12.7	40	29.5	205	10	392,50
0331 02 0020	25/32"	275	7.7	13.2	42	31	230	10	419,00
0331 02 0021	13/16"	288	8.1	13.3	44	31.5	260	5	463,25
0331 02 0022	7/8"	300	8.5	13.7	46	34	310	5	533,00
0331 02 0024	15/16"	330	9	14.2	50	37	380	5	651,75
0331 02 0025	1"	340	9.3	14.7	52	38.5	380	5	651,75
0331 02 0027	1 1/16"	360	10	15.2	56	41	470	5	763,25
0331 02 0028	1 1/8"	370	10.4	15.7	57.5	43	470	5	763,25
0331 02 0030	1 3/16"	410	11.2	16.6	61.5	45	635	5	873,75
0331 02 0032	1 1/4"	420	11.5	17.1	65.5	48	775	5	915,75
0331 02 0033	1 5/16"	430	11.8	17.4	71	50.5	775	5	915,75
0331 02 0038	1 1/2"	450	12.5	18.7	80	56	1015	5	1.106,50

**ÖZEL SERİLER (adet ve termin süresi isteyiniz)**  
**SPECIAL SERIES (ask for quantity and delivery terms)**

0331 02 0035	1 3/8"	440	12.2	17.7	76	53	1015	5	-
0331 02 0036	1 7/16"	440	12.2	17.7	76	53	1015	5	-
0331 02 0041	1 5/8"	480	13.5	19.7	87	61	1325	5	-
0331 02 0046	1 13/16"	505	14.7	20.7	95	67.5	1750	5	-
0331 02 0050	2"	540	15.9	22.7	104	73.5	2200	5	-

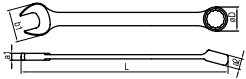
KOD CODE	İÇERİK CONTENTS	g	TL/ Ad.	
0331 00 2108	5/16" - 3/8" - 7/16" - 1/2" - 9/16" - 5/8" 11/16" - 3/4"	925	8	2.241,00
0331 00 2112	5/16" - 3/8" - 7/16" - 1/2" - 9/16" - 5/8" 11/16" - 3/4" - 13/16" - 7/8" - 15/16" - 1"	2320	12	4.540,75
0331 00 2117	1/4" - 5/16" - 3/8" - 7/16" - 1/2" - 9/16" 19/32" - 5/8" - 11/16" - 3/4" - 25/32" 13/16" - 7/8" - 15/16" - 1" - 1 1/16" - 1 3/16"	3875	17	7.060,00
0331 00 2120	1/4" - 5/16" - 3/8" - 7/16" - 1/2" - 9/16" 19/32" - 5/8" - 11/16" - 3/4" - 25/32" 13/16" - 7/8" - 15/16" - 1" - 1 1/16" 1 1/8" - 1 3/16" - 1 1/4" - 1 5/16"	5880	20	9.654,75

**Circir Kombine Anahtar (mm)**  
 Combination Wrench With Ratchet (mm)

 Krom vanadyum, Krom kaplı  
 Chrom vanadium, Chrom plated

KOD CODE	mm	L mm	a1 mm	a2 mm	b1 mm	øD mm	g	TL/Ad.
0340 02 0008	8	136	3.2	7	18	17.5	35	584,50
0340 02 0009	9	143	3.5	7.6	20	19.3	40	583,25
0340 02 0010	10	160	3.8	7.7	22	21	55	611,00
0340 02 0011	11	169	4.1	8.3	24.5	22.7	70	614,50
0340 02 0012	12	174	4.3	8.7	26.5	24	80	666,00
0340 02 0013	13	180	4.6	9.3	27.6	26	90	713,00
0340 02 0014	14	193	5	9.4	31.4	27.7	120	734,50
0340 02 0015	15	200	5.2	10	33.4	29	135	779,00
0340 02 0016	16	216	5.4	10.6	34.6	30.7	155	891,75
0340 02 0017	17	233	5.6	10.9	38.4	33	190	944,50
0340 02 0018	18	239	5.7	11.2	39.9	33.7	200	1.023,75
0340 02 0019	19	250	6	11.5	41.5	34.8	240	1.087,25
0340 02 0021	21	285	6.4	13	45.8	42	350	1.512,00
0340 02 0022	22	285	6.4	13	45.8	42	340	1.658,50
0340 02 0024	24	325	7	14.5	51.5	47.5	470	1.873,25

**0340**
**Circir Kombine Anahtar Takımı (mm)**  
 Combination Wrench With Ratchet, Set (mm)

KOD CODE	İÇERİK CONTENTS	g	TL/Ad.
0340 00 2110	8 - 9 - 10 - 11 12 - 13 - 14 - 15 - 17 - 19	1315	10 7.317,50
0340 00 2115	8 - 9 - 10 - 11 - 12 - 13 14 - 15 - 16 - 17 - 18 - 19 - 21 - 22 - 24	2445	15 14.276,75

**13000 005343**
**Circir Kombine Anahtar Takımı (4 parça, mm)**  
 Combination Wrench With Ratchet Set (4 pcs, mm)

KOD CODE	İÇERİK CONTENTS	g	TL/Ad.
13000 005343	10 - 13 - 17 - 19	595	4 3.355,75





### Mafsallı Cırcır Kombine Anahtar (mm) Flexible Head Combination Wrench With Ratchet (mm)

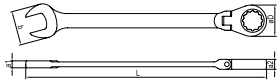

Krom vanadyum, Krom kaplı  
Chrom vanadium, Chrom plated

KOD CODE	mm	L mm	a1 mm	a2 mm	b mm	σD mm	g		TL/Ad.
0345 02 0008	8	136	5.5	7	17	17.5	40	10	966,00
0345 02 0009	9	140	6.1	7.7	21.5	21	50	10	985,25
0345 02 0010	10	140	6.1	7.7	21.5	21	60	10	1.025,00
0345 02 0011	11	142	6.4	8.3	23.5	22.5	80	10	1.056,00
0345 02 0012	12	143	6.7	8.7	26	24	90	10	1.117,25
0345 02 0013	13	156	7	9.3	27	26	105	10	1.165,25
0345 02 0014	14	164	7.3	9.4	30.5	27.5	125	10	1.225,25
0345 02 0015	15	174	7.7	10	32	29	145	10	1.285,25
0345 02 0016	16	176	8	10.6	34	30.5	185	10	1.399,25
0345 02 0017	17	195	8.3	10.9	37	32.5	210	10	1.417,25
0345 02 0018	18	213	8.6	11.2	38.5	33.5	235	10	1.525,25
0345 02 0019	19	214	9	11.5	40	35	260	10	1.593,75

**0345 00 2112**

### Mafsallı Cırcır Kombine Anahtar Takımı (mm) Flexible Head Combination Wrench With Ratchet, Set (mm)



KOD CODE	İÇERİK CONTENTS	g		TL/Ad.
0345 00 2112	8 - 9 - 10 - 11 - 12 - 13 14 - 15 - 16 - 17 - 18 - 19	1365	12	14.760,75

**0335 02 0010**

### Çoklu Yıldız Cırcır Anahtar (mm) Multi-Ring Wrench (mm)



Krom vanadyum, Krom kaplı  
Chrom vanadium, Chrom plated

KOD CODE	ÖLÇÜ SIZE	L mm	g		TL/Ad.
0335 02 0010	10x13x17x19	230	215	5	2.162,50

**Boyunlu Kombine Anahtar (mm)**  
**Offset Combination Wrench (mm)**

TS 3794  
 TS ISO 7738 Form B  
 DIN 3113

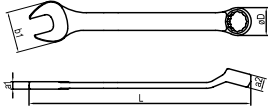

Krom vanadyum, Krom kaplı  
 Chrom vanadium, Chrom plated

**0370**
**Boyunlu Kombine Anahtar Takımı (mm)**  
**Offset Combination Wrench, Set (mm)**

KOD CODE	mm	L mm	a1 mm	a2 mm	b1 mm	øD mm	g	TL/ Ad.	
0370 02 0006	6	110	3.8	5.6	16	10.5	20	10	140,50
0370 02 0007	7	120	4	6.2	18	12	25	10	149,00
0370 02 0008	8	130	4.2	6.7	20	13	30	10	161,00
0370 02 0009	9	140	4.4	7.3	22	14.5	35	10	164,50
0370 02 0010	10	150	4.6	7.8	24	16	40	10	186,00
0370 02 0011	11	160	4.8	8.4	26	17	50	10	192,00
0370 02 0012	12	167	5	9	28	18.5	65	10	205,25
0370 02 0013	13	175	5.4	9.6	30	20	75	10	210,00
0370 02 0014	14	185	5.8	10.2	32	21.5	90	10	225,75
0370 02 0015	15	195	6.2	10.8	34	23	105	10	240,00
0370 02 0016	16	210	6.6	11.4	36	24.5	120	10	258,00
0370 02 0017	17	225	7	12	38	26	160	10	276,00
0370 02 0018	18	237	7.4	12.4	40	27.5	170	10	306,00
0370 02 0019	19	250	7.8	13	42	29	200	10	323,00
0370 02 0020	20	267	8.2	13.2	44	30.5	230	10	338,50
0370 02 0021	21	283	8.6	13.8	46	32	265	10	380,50
0370 02 0022	22	295	9.1	14.6	48	34.5	300	10	435,75
0370 02 0023	23	295	9.1	14.6	48	34.5	300	5	531,75
0370 02 0024	24	329	9.4	15.4	52	37	380	5	531,75
0370 02 0025	25	329	9.4	15.4	52	37	380	5	531,75
0370 02 0026	26	360	10.2	16.8	58	41	485	5	626,50
0370 02 0027	27	360	10.2	16.8	58	41	475	5	626,50
0370 02 0028	28	360	10.2	16.8	58	41	470	5	626,50
0370 02 0029	29	394	11	18.2	64	44.5	610	5	697,25
0370 02 0030	30	394	11	18.2	64	44.5	620	5	719,00
0370 02 0032	32	435	11.8	19.7	66	47.5	765	5	753,75
0370 02 0036	36	468	12.6	21.2	76	53	1020	5	871,25

KOD CODE	İÇERİK CONTENTS	g	TL/ Ad.	
0370 00 2108	6 - 7 - 8 - 9 - 10 - 13 - 17 - 19	665	8	1.610,00
0370 00 2112	8 - 9 - 10 - 11 - 12 - 13 - 14 15 - 16 - 17 - 19 - 22	1375	12	2.877,25
0370 00 2117	6 - 7 - 8 - 9 - 10 - 11 - 12 - 13 - 14 15 - 16 - 17 - 18 - 19 - 20 - 21 - 22	2100	17	4.191,75
0370 00 2121	6 - 7 - 8 - 9 - 10 - 11 - 12 - 13 - 14 - 15 16 - 17 - 18 - 19 - 20 - 21 - 22 - 24 - 27 30 - 32	4425	21	6.822,75

## Torx® - mm Kombine Anahtar

### Torx® - mm Combination Wrench

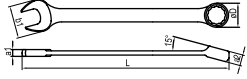

Krom vanadyum, Krom kaplı  
Chrom vanadium, Chrom plated

KOD CODE	mm	*	L mm	a1 mm	a2 mm	b1 mm	øD mm	g	TL/ Ad.	
0380 02 0008	8	E10	170	4.5	7.5	20.5	13	45	10	279,75
0380 02 0009	9	E12	180	4.5	8	22.5	14.5	45	10	284,50
0380 02 0010	10	E14	190	5	8.5	24.5	16	60	10	314,50
0380 02 0011	11	E14	200	5.5	9	26.5	17	75	10	332,50
0380 02 0012	12	E16	210	6	9.5	28.5	19	90	10	341,00
0380 02 0013	13	E18	225	6.5	10	30.5	20	110	10	373,25
0380 02 0014	14	E18	235	7	11	32.5	22	120	10	414,00
0380 02 0015	15	E20	250	7.5	12	34.5	23	150	10	437,00
0380 02 0017	17	E22	280	8.5	14	38.5	26.5	210	10	474,00
0380 02 0018	18	E24	295	9	15	40.5	28	240	10	516,00
0380 02 0019	19	E24	310	9.5	16	42.5	29.5	280	10	557,00
0380 02 0022	22	E26	350	11	18	48.5	34.5	410	10	750,00

## 0380

## Torx® - mm Kombine Anahtar Takımı

### Torx® - mm Combination Wrench Set

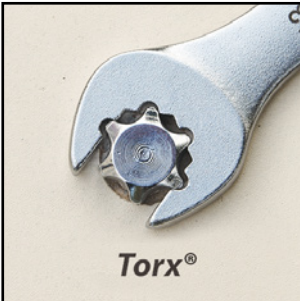
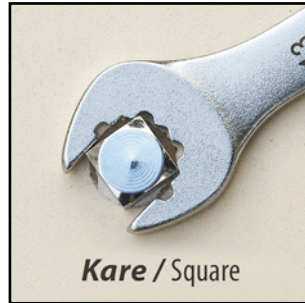

**Torx® - mm Kombine Anahtar:** Bir çatal ağız ve bir yıldız ağızdan oluşan anahtarlarımız 8-22 mm arasında boyları bulunmaktadır. Çatal ağız kısmı mevcut çatal anahtarlardan farklı olarak 6 köşe civatanın yanısıra farklı geometri lere sahip civataları açabilmekte ve sıkabilmektedir.

**TORX-mm combination wrench:** Our wrenches consisting of an open end and a ring end are available in sizes from 8 to 22 mm. Unlike the existing open end wrenches, its open end can unbolt and tighten bolts with different geometries as well as the

KOD CODE	İÇERİK CONTENTS	g	TL/ Ad.
	8 - 9 - 10 - 11 - 12 - 13 - 17 - 19		
0380 00 2108	E10 - E12 - E14 - E14 E16 - E18 - E22 - E24	790	8 2.956,50
	8 - 9 - 10 - 11 - 12 - 13 14 - 15 - 17 - 18 - 19 - 22		
0380 00 2112	E10 - E12 - E14 - E14 - E16 - E18 E18 - E20 - E22 - E24 - E24 - E26	1590	12 5.073,50



**Yıldız İki Ağız Anahtar (mm)**  
**Double Ended Ring Wrench (mm)**

TS 3794  
TS ISO 10104 Form B  
DIN 838

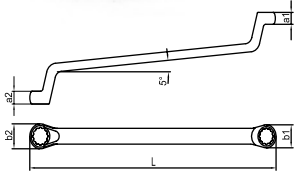

Krom vanadyum, Krom kaplı  
Chrom vanadium, Chrom plated

KOD CODE	mm	L mm	a1 mm	a2 mm	b1 mm	b2 mm	g	TL/Ad.
0430 03 0607	6x7	176	5.6	6	10	11.5	55	210,00
0430 03 0809	8x9	190	6.4	6.8	13	14.5	75	212,50
0430 03 0810	8x10	190	6.4	7.3	13	15.5	70	212,50
0430 03 1011	10x11	206	7.3	7.6	15.5	17	105	235,25
0430 03 1012	10x12	206	7.3	8.5	15.5	18.5	105	235,25
0430 03 1013	10x13	220	7.3	9	15.5	20	120	266,50
0430 03 1113	11x13	220	8.5	9	18.5	20	130	266,50
0430 03 1213	12x13	220	8.5	9	18.5	20	135	266,50
0430 03 1214	12x14	220	8.5	9.5	18.5	23	145	266,50
0430 03 1415	14x15	236	9.5	10	21.5	23	180	281,00
0430 03 1317	13x17	250	9	11.5	20	26.5	215	318,00
0430 03 1417	14x17	250	9.5	11.5	21.5	26.5	210	318,00
0430 03 1617	16x17	250	10.8	11.5	25	26.5	220	318,00
0430 03 1618	16x18	260	10.8	12	25	27.5	210	377,00
0430 03 1719	17x19	271	11.5	12.5	26.5	29	270	377,00
0430 03 1819	18x19	271	12	12.5	27.5	29	270	377,00
0430 03 1922	19x22	291	12.5	13.5	29	33	330	544,00
0430 03 1924	19x24	311	12.5	14.2	29	36.5	345	544,00
0430 03 2022	20x22	291	12.9	13.5	30.5	33	330	544,00
0430 03 2123	21x23	311	13.1	14	32	35	410	574,00
0430 03 2224	22x24	321	13.5	14.2	33	36.5	410	574,00
0430 03 2426	24x26	331	14.2	14.6	36.5	39.5	495	552,00
0430 03 2427	24x27	331	14.2	15	36.5	40.5	495	552,00
0430 03 2430	24x30	352	14.2	16.7	36.5	45	530	603,75
0430 03 2528	25x28	352	14.5	15.5	38	42.5	550	603,75
0430 03 2729	27x29	371	15	16.7	40.5	45	660	665,00
0430 03 2730	27x30	371	15	16.7	40.5	45	660	665,00
0430 03 2732	27x32	371	15	16.7	40.5	47.5	660	665,00
0430 03 3032	30x32	371	16.4	16.7	45	47.5	660	665,00
0430 03 3036	30x36	402	16.4	17.5	45	53	880	1.023,75
0430 03 3236	32x36	402	16.7	17.5	47.5	53	890	1.023,75
0430 03 3436	34x36	420	17.1	17.5	50	53	1000	1.251,75
0430 03 3641	36x41	438	17.5	19.5	53	61	1150	1.391,00
0430 03 4146	41x46	485	19.5	20.5	61	67.5	1430	1.904,50
0430 03 4650	46x50	535	20.5	22.4	67.5	73.5	1960	3.030,00

**ÖZEL SERİLER (adet ve termin süresi isteyiniz)**  
**SPECIAL SERIES (ask for quantity and delivery terms)**



0430 03 1014	10x14	220	7.3	9	15.5	21.5	120	10	-
0430 03 1315	13x15	236	9	10	20	23	170	10	-
0430 03 2227	22x27	331	14.2	15	36.5	40.5	500	5	-
0430 03 3034	30x34	379	16.4	16.9	45	50	690	5	-

**0430**
**Yıldız İki Ağız Anahtar Takımı (mm)**  
**Double Ended Ring Wrench Set (mm)**

KOD CODE	İÇERİK CONTENTS	g	TL/Ad.
0430 00 2108	6x7 - 8x9 - 10x11 - 12x13 - 14x15 16x17 - 18x19 - 20x22	1450	8 2.314,25
0430 00 2112	6x7 - 8x9 - 10x11 - 12x13 - 14x15 16x17 - 18x19 - 20x22 - 21x23 24x26 - 25x28 - 27x32	3610	12 4.609,00

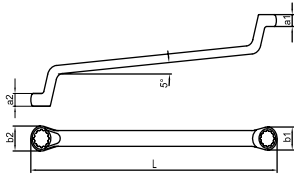

**Yıldız İki Ağız Anahtar (SAE)**  
**Double Ended Ring Wrench (SAE)**
**TSEK**

**Krom vanadyum, Krom kaplı**  
**Chrom vanadium, Chrom plated**
**0431**
**Yıldız İki Ağız Anahtar Takımı (SAE)**  
**Double Ended Ring Wrench, Set (SAE)**
**TSEK**

KOD CODE	 inch	L mm	a1 mm	a2 mm	b1 mm	b2 mm	 g		TL/ Ad.
0431 03 0608	1/4"x5/16"	176	5.6	6	10	11.5	55	10	259,25
0431 03 0809	5/16"x3/8"	190	6.4	6.8	13	14.5	75	10	269,00
0431 03 0811	5/16"x7/16"	190	6.4	7.3	13	15.5	115	10	281,00
0431 03 0911	3/8"x7/16"	206	7.3	7.6	15.5	17	115	10	296,50
0431 03 1112	7/16"x1/2"	220	8.5	9	18.5	20	135	10	319,25
0431 03 1214	1/2"x9/16"	236	9	10	20	23	145	10	337,25
0431 03 1415	9/16"x19/32"	236	9.5	10	21.5	23	165	10	337,25
0431 03 1416	9/16"x5/8"	236	9.5	10	21.5	24	165	10	341,00
0431 03 1517	19/32"x11/16"	250	10.8	11.5	25	26.5	210	10	380,50
0431 03 1920	3/4"x25/32"	271	12	12.5	27.5	29	270	10	473,00
0431 03 2122	13/16"x7/8"	311	13.1	14	32	35	400	5	567,75
0431 03 2325	15/16"x1"	331	14.2	14.6	36.5	39.5	495	5	662,50
0431 03 2631	11/16"x1 1/4"	371	15	16.7	40.5	48	640	5	797,00
0431 03 2833	11/8"x1 5/16"	371	15	16.7	40.5	48	660	5	797,00
0431 03 3033	1 3/16"x1 5/16"	371	16.4	16.7	45	48	670	5	849,75

**ÖZEL SERİLER (adet ve termin süresi isteyiniz)**  
**SPECIAL SERIES (ask for quantity and delivery terms)**

0431 03 1217	1/2"x11/16"	250	9	10	20	26.5	185	10	-
0431 03 1417	9/16"x11/16"	250	9.5	11.5	21.5	26.5	185	10	-
0431 03 1617	5/8"x11/16"	250	10.8	11.5	25	26.5	210	10	-
0431 03 1619	5/8"x3/4"	271	11.5	12.5	26.5	29	270	10	-
0431 03 2021	25/32"x13/16"	291	12.9	13.5	30.5	33	270	5	-
0431 03 1922	3/4"x7/8"	291	12.9	13.5	30.5	33	400	5	-
0431 03 2223	7/8"x15/16"	321	13.5	14.2	33	36.5	400	5	-
0431 03 2328	15/16"x1 1/8"	331	14.2	15	36.5	40.5	500	5	-
0431 03 2528	1"x1 1/8"	352	14.5	15.5	38	42.5	570	5	-
0431 03 3036	1 3/16"x1 3/8"	402	16.4	17.5	45	53	880	5	-
0431 03 3236	1 1/4"x1 7/16"	402	16.7	17.5	48	53	890	5	-
0431 03 3641	1 7/16"x1 5/8"	438	17.5	19.5	53	61	1100	5	-
0431 03 4146	1 11/16"x1 7/8"	485	19.5	20.5	61	67.5	1390	5	-
0431 03 4650	1 13/16"x2"	535	20.5	22.5	67.5	73.5	1955	5	-

KOD CODE	İÇERİK CONTENTS	 g		TL/Ad.
0431 00 2108	1/4"x5/16" - 5/16"x3/8" 7/16"x1/2" - 9/16"x5/8" 19/32"x11/16" 3/4"x25/32" - 13/16"x7/8" 15/16"x1"	1915	8	3.272,25
0431 00 2112	1/4"x5/16" - 5/16"x3/8" 3/8"x7/16" - 7/16"x1/2" 9/16"x5/8" - 19/32"x11/16" 3/4"x25/32" - 13/16"x7/8" 15/16"x1" - 11/16"x1 1/4" 1 1/8"x1 5/16" 1 3/16"x1 5/16"	3985	12	6.012,50

**Düz Yıldız Anahtar (mm)**  
 Flat Ring Wrench (mm)

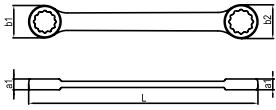
 TS 3794  
 TS ISO 10103  
 DIN 837-B

 Krom vanadyum, Krom kaplı  
 Chrom vanadium, Chrom plated

KOD CODE	mm	L mm	a1 mm	b1 mm	b2 mm	g	TL/ Ad.
0440 03 0607	6x7	99	4.4	9.5	11	10	193,25
0440 03 0809	8x9	113	5.2	12.5	14	25	201,75
0440 03 1011	10x11	125	6	15.5	16.5	30	223,25
0440 03 1213	12x13	140	6.8	18.5	20	45	241,25
0440 03 1415	14x15	156	7.2	21	22.5	60	281,00
0440 03 1617	16x17	170	8	24	25	80	332,50
0440 03 1819	18x19	188	8.8	26.5	27.5	105	347,00
0440 03 2022	20x22	208	9.6	29	32	135	403,25
0440 03 2123	21x23	230	10.6	30	33	170	477,75
0440 03 2426	24x26	256	10.8	35	37.5	225	483,75
0440 03 2528	25x28	280	11.8	36	40.5	270	564,00
0440 03 2732	27x32	310	12.8	38.5	45.5	355	697,25

**ÖZEL SERİLER (adet ve termin süresi isteyiniz)**  
**SPECIAL SERIES (ask for quantity and delivery terms)**

0440 03 0810	8x10	120	5.6	12.5	15.5	30	10	-
0440 03 1013	10x13	140	6.8	18.5	20	45	10	-
0440 03 1315	13x15	156	7.2	20	22.5	55	10	-
0440 03 1317	13x17	165	7.8	20.2	25.2	85	10	-
0440 03 1618	16x18	188	8.8	26.5	27.5	90	10	-
0440 03 1719	17x19	188	8.8	26.5	27.5	105	10	-
0440 03 2224	22x24	230	10.8	32	35	170	10	-
0440 03 2427	24x27	256	10.8	35	38.5	225	10	-
0440 03 2729	27x29	290	12.8	38.5	42.5	285	10	-
0440 03 3032	30x32	310	12.8	43	45.5	360	10	-

**0440**
**Düz Yıldız Anahtar Takımı (mm)**  
 Flat Ring Wrench, Set (mm)

KOD CODE	İÇERİK CONTENTS	g	TL/ Ad.
0440 00 2108	6x7 - 8x9 - 10x11 - 12x13 - 14x15 16x17 - 18x19 - 20x22	560	8 2.223,25
0440 00 2112	6x7 - 8x9 - 10x11 - 12x13 - 14x15 16x17 - 18x19 - 20x22 - 21x23 24x26 - 25x28 - 27x32	1540	12 4.446,00



**0435**
**Süper İzoleli Bir Ağız Yıldız Anahtar (mm)**  
 Single Ended Ring Wrench Super Insulated (mm)

 ⚡ 1000 V  
 IEC 60900

**Krom vanadyum, Krom kaplı, Kalın PVC izoleli**  
 Chrom vanadium, Chrom plated, Triple PVC insulated

KOD CODE	mm	L mm	g		TL/Ad.
0435 03 0010	10	170	100	10	417,75
0435 03 0011	11	175	110	10	417,75
0435 03 0012	12	180	130	10	474,00
0435 03 0013	13	185	150	10	474,00
0435 03 0014	14	190	180	10	498,00
0435 03 0017	17	205	220	10	564,00
0435 03 0019	19	220	270	10	672,00
0435 03 0022	22	245	310	10	737,00
0435 03 0024	24	270	420	10	984,00

**0530**
**Yarım Ay Anahtar Yıldız İki Ağız (mm)**  
 Double - Hex Starter and Block Wrench (mm)

TSEK

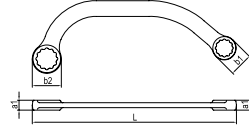
**Krom vanadyum, Krom kaplı**  
 Chrom vanadium, Chrom plated

KOD CODE	mm	L mm	a1 mm	b1 mm	b2 mm	g		TL/ Ad.
0530 04 0810	8x10	120	6	12.5	15.5	30	10	248,50
0530 04 1011	10x11	150	7	17	20	55	10	291,75
0530 04 1012	10x12	150	7	17	20	55	10	291,75
0530 04 1113	11x13	150	7	17	20	55	10	291,75
0530 04 1315	13x15	185	9	21.5	26	110	10	347,00
0530 04 1317	13x17	185	9	21.5	26	105	10	347,00
0530 04 1417	14x17	185	9	21.5	26	110	10	347,00
0530 04 1517	15x17	185	9	21.5	26	100	10	347,00
0530 04 1922	19x22	230	11	29	33	195	10	450,00

**0540**
**Rakor Anahtar (mm)**  
 Flare Nut Wrench (mm)

DIN 3118

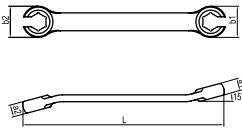
**Krom vanadyum, Krom kaplı**  
 Chrom vanadium, Chrom plated

KOD CODE	mm	L mm	a1 mm	a2 mm	b1 mm	b2 mm	g		TL/ Ad.
0540 01 0810	8x10	130	7	8.5	18	20	60	10	384,00
0540 01 1011	10x11	150	8.5	9.3	20	22	75	10	399,75
0540 01 1012	10x12	150	8.5	9.3	20	22	75	10	399,75
0540 01 1113	11x13	170	9.3	10.8	22	25.5	105	10	427,25
0540 01 1214	12x14	170	9.3	10.8	22	25.5	105	10	427,25
0540 01 1719	17x19	210	11.8	13	30.5	33.5	185	10	762,00
0540 01 1922	19x22	230	12.8	14.9	33.5	39.5	235	10	912,00

**0531**
**Yarım Ay Anahtar Yıldız İki Ağız (SAE)**  
 Double - Hex Starter and Block Wrench (SAE)

TSEK

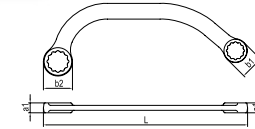

**Krom vanadyum, Krom kaplı**  
 Chrom vanadium, Chrom plated

KOD CODE	inch	L mm	a1 mm	b1 mm	b2 mm	g		TL/Ad.
0531 04 1112	7/16"x1/2"	150	7	17	20	50	10	359,00
0531 04 1214	1/2"x9/16"	185	9	21.5	26	110	10	417,75
0531 04 1416	9/16"x5/8"	185	9	21.5	26	115	10	429,75
0531 04 1922	3/4"x7/8"	230	11	29	33	195	10	541,25

**ÖZEL SERİLER (adet ve termin süresi isteyiniz)**  
**SPECIAL SERIES (ask for quantity and delivery terms)**

0531 04 0809	5/16"x3/8"	120	6	12.5	15.5	30	10	-
0531 04 0911	3/8"x7/16"	150	7	17	20	50	10	-
0531 04 1417	9/16"x11/16"	185	9	21.5	26	110	10	-

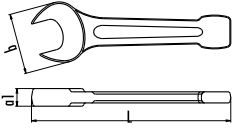
**Çatal Çakma Anahtar (mm)**  
**Slugging Open Jaw Wrench (mm)**

 TS 81  
 DIN 133

**Krom vanadyum**  
**Chrom vanadium**

KOD CODE	mm	L mm	a1 mm	b mm	g		TL/Ad.
0700 05 0024	24	160	14	50	280	1	499,25
0700 05 0027	27	180	15	55	385	1	619,25
0700 05 0030	30	190	16	64	525	1	761,00
0700 05 0032	32	190	16	64	530	1	853,25
0700 05 0036	36	210	18	75	755	1	957,75
0700 05 0038	38	210	18	75	760	1	1.153,25
0700 05 0041	41	230	18	85	920	1	1.253,00
0700 05 0042	42	230	18	85	930	1	1.447,25
0700 05 0046	46	255	20	95	1305	1	1.592,50
0700 05 0047	47	255	20	95	1320	1	1.860,00
0700 05 0050	50	275	20	105	1565	1	1.989,75
0700 05 0055	55	310	23	119	2305	1	2.666,50
0700 05 0060	60	310	23	119	2310	1	2.894,50
0700 05 0065	65	340	28	135	3300	1	4.163,00
0700 05 0070	70	375	31	154	4555	1	5.328,00
0700 05 0075	75	375	31	154	4460	1	5.646,00
0700 05 0080	80	405	34	169	6115	1	7.178,50
0700 05 0085	85	405	34	169	5740	1	9.516,00
0700 05 0090	90	445	38	189	8040	1	9.792,00
0700 05 0095	95	445	38	189	8160	1	10.442,50
0700 05 0100	100	485	44	214	12355	1	14.799,75
0700 05 0105	105	485	44	214	11785	1	15.260,50
0700 05 0110	110	510	50	234	15000	1	17.412,00
0700 05 0115	115	510	50	234	14830	1	20.001,75
0700 05 0120	120	543	54	254	18865	1	21.113,00

**ÖZEL SERİLER (adet ve termin süresi isteyiniz)**  
**SPECIAL SERIES (ask for quantity and delivery terms)**

0700 05 0125	125	543	54	254	17250	1	-
0700 05 0130	130	560	56	275	20000	1	-
0700 05 0135	135	560	56	275	19700	1	-
0700 05 0140	140	630	58.5	310	19400	1	-
0700 05 0145	145	630	58.5	310	28000	1	-
0700 05 0150	150	630	58.5	310	27600	1	-

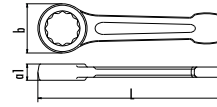
**Yıldız Çakma Anahtar (mm)**  
**Slugging Ring Wrench (mm)**

 TS 3794  
 DIN 7444

**Krom vanadyum**  
**Chrom vanadium**

KOD CODE	mm	L mm	a1 mm	b mm	g		TL/Ad.
0750 05 0024	24	160	15	41.5	235	1	699,75
0750 05 0027	27	180	16	45.5	325	1	835,25
0750 05 0030	30	190	17	51	435	1	995,00
0750 05 0032	32	190	17	51	425	1	1.143,75
0750 05 0036	36	205	19	58	550	1	1.295,00
0750 05 0038	38	205	19	58	530	1	1.550,50
0750 05 0041	41	225	20	63	730	1	1.692,00
0750 05 0042	42	225	20	63	700	1	1.934,50
0750 05 0046	46	240	22	71	970	1	2.022,00
0750 05 0047	47	240	22	71	930	1	2.232,00
0750 05 0050	50	255	23	77	1160	1	2.388,00
0750 05 0055	55	272	25	88	1520	1	3.359,00
0750 05 0060	60	272	25	88	1460	1	3.643,25
0750 05 0065	65	300	28	98	2025	1	4.763,00
0750 05 0070	70	330	32	108	2890	1	5.453,00
0750 05 0075	75	330	32	108	2755	1	5.837,00
0750 05 0080	80	360	35	126	4000	1	8.289,75
0750 05 0085	85	360	35	126	3620	1	9.326,50
0750 05 0090	90	390	40	140	5465	1	11.472,00
0750 05 0095	95	390	40	140	5250	1	12.935,00
0750 05 0100	100	420	44	148	6755	1	14.953,25
0750 05 0105	105	420	44	148	6445	1	15.435,75
0750 05 0110	110	450	48	166	8500	1	16.501,25
0750 05 0115	115	450	48	166	8460	1	18.495,75
0750 05 0120	120	490	54	178	10000	1	25.421,00

**ÖZEL SERİLER (adet ve termin süresi isteyiniz)**  
**SPECIAL SERIES (ask for quantity and delivery terms)**

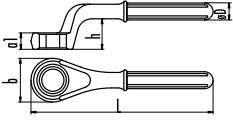
0750 05 0125	125	490	54	178	9900	1	-
0750 05 0130	130	518	59	196	16000	1	-
0750 05 0135	135	518	59	196	15900	1	-
0750 05 0140	140	518	59	196	15800	1	-
0750 05 0145	145	580	61.8	223	22000	1	-
0750 05 0150	150	580	61.8	223	21900	1	-
0750 05 0155	155	580	61.8	223	21800	1	-
0750 05 0160	160	580	61.8	223	21700	1	-
0750 05 0165	165	648	67	262	30000	1	-
0750 05 0170	170	648	67	262	29800	1	-
0750 05 0180	180	648	67	262	29700	1	-

**0550**
**Boru Uzatmalı Yıldız Anahtar (mm)**  
**Offset Ring Wrench (mm)**

**Krom vanadyum, Krom kaplı**  
**Chrom vanadium, Chrom plated**

KOD CODE	Ø mm	L mm	a1 mm	b mm	ØD mm	h mm	g	TL/Ad.
0550 05 0024	24	180	17	37	18.5	30	400	1 731,00
0550 05 0027	27	190	18	42	18.5	33	450	1 871,25
0550 05 0030	30	200	20	46	18.5	34	520	1 1.040,50
0550 05 0032	32	235	21.5	49	21.2	37	700	1 1.194,00
0550 05 0036	36	245	23	53.5	21.2	42	830	1 1.350,00
0550 05 0038	38	270	25	60.5	21.2	43	965	1 1.557,75
0550 05 0041	41	270	25	60.5	21.2	43	950	1 1.765,25
0550 05 0046	46	280	26	68	24.2	45	1240	1 2.111,00
0550 05 0050	50	290	28	74	24.2	47	1410	1 2.492,50
0550 05 0055	55	300	30	79	24.2	50	1550	1 3.504,00
0550 05 0060	60	345	32	89	29	50.5	2390	1 3.803,00
0550 05 0065	65	355	34	98	29	56.5	2730	1 4.118,50

**ÖZEL SERİLER (adet ve termin süresi isteyiniz)**  
**SPECIAL SERIES (ask for quantity and delivery terms)**

0550 05 0022	22	180	17	37	18.5	30	400	1 --
0550 05 0034	34	235	21.5	49	21.2	37	750	1 -
0550 05 0070	70	365	37	104	29	55	2900	1 -
0550 05 0075	75	375	40	109	29	57.5	3100	1 -
0550 05 0080	80	385	43	124	29	59	3900	1 -
0550 05 0085	85	385	43	124	29	59	3750	1 -
0550 05 0090	90	410	46	140	29	63	5100	1 -
0550 05 0095	95	410	46	140	29	63	4950	1 -
0550 05 0100	100	420	46	150	29	65	4800	1 -

**0551**
**Döndürme Kolu Borusu**  
**Tubular Handle**

**Dikişsiz Çelik Boru**  
**Seamless Steel Pipe**

KOD CODE	Ø mm	L mm	Ø mm	g	TL/Ad.
0551 05 0001	22 - 30	460	25	700	1 684,00
0551 05 0002	32 - 41	610	27	1220	1 926,50
0551 05 0003	46 - 55	760	32.2	1880	1 1.387,25
0551 05 0004	60 - 100	860	38	2975	1 1.872,00

**0600**
**Kurbağacık Anahtar**  
**Adjustable Wrench**
  
**TS ISO 6787**

 **Yedek parça sayfa 255-259**  
**Spare parts page 255-259**

**İZELTAS YOUTUBE**
**Krom vanadyum, Krom kaplı, PVC izoleli**  
**Chrom vanadium, Chrom plated, PVC insulated**

KOD CODE	L mm	L inch	Ø mm	g	TL/Ad.
0600 01 1006	160	6"	19	120	5 672,00
0600 01 1008	208	8"	24	230	5 840,00
0600 01 1010	260	10"	27	400	5 1.082,50
0600 01 1012	308	12"	34	670	5 1.496,50
0600 01 1015	388	15"	41	1555	1 2.343,75

**0600 01 0010**
**1000V İzoleli Kurbağacık Anahtar**  
**Insulated Electrician Type Adjustable**  
**Wrench 1000V**
**TS ISO 6787**  
**△ 1000 V**  
**EC 60900**
**YENİ**  
**NEW**

 **Yedek parça sayfa 255-259**  
**Spare parts page 255-259**
**Krom vanadyum, Krom kaplı, Kalın PVC izoleli**  
**Chrom vanadium, Chrom plated, Triple PVC insulated**

KOD CODE	L mm	L inch	Ø mm	g	TL/Ad.
0600 01 0010	260	10"	27	440	5 1.577,00

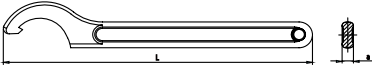

**Kanca Anahtar (dörtgen uçlu)**  
Hook WrenchTS 3798  
DIN 1810**Krom vanadyum, Krom kaplı**  
Chrom vanadium, Chrom plated

KOD CODE	 mm	L mm	a1 mm	 g		TL/Ad.
0860 05 2528	25/28	136	4	50	10	359,00
0860 05 3032	30/32	136	4	50	10	359,00
0860 05 3436	34/36	171	5	95	10	387,75
0860 05 4042	40/42	171	5	95	10	387,75
0860 05 4550	45/50	210	6	160	10	449,00
0860 05 5255	52/55	210	6	160	10	449,00
0860 05 5862	58/62	242	7	270	5	541,25
0860 05 6875	68/75	242	7	270	5	541,25
0860 05 8090	80/90	281	8	400	5	707,00
0860 05 9510	95/100	281	8	400	5	707,00



# LOKMA VE BİJON ANAHTARLARI

## SOCKET AND RIM WRENCHES

- Lokma Anahtarlar  
Socket Wrenches
- Lokma Takımları  
Socket Wrench Sets
- Kovan Anahtarlar  
Tubular Socket Wrenches
- Bijon Anahtarlar  
Rim Wrenches
- Tork Anahtarları  
Torque Wrenches



## Tork (Moment) ve Kuvvet / Torque (Moment) and Force

» Bilindiği üzere kuvvet bir cisme hareketini veren etkidir. Tork ise cismin bir kuvvet etkisinde döndürülmesidir. Bağlantı elemanlarını sıkma işlemlerinde genel olarak yıldız, çatal ya da lokma anahtar gibi çeşitli el aletleri kullanılır. Bu işlem fiziksel olarak işlevsel ve doğru olarak gözüke de vida, civata bağlantısının güvenilirliği açısından doğru bir çalışma şekli değildir. Bir vida-civata bağlantısının çözülmeye karşı en büyük emniyeti teorik olarak hesaplanmış olan tork değeri ile sıkılmasıdır. Bu da ancak çeşitli modern yöntemler ile sağlanabilir. Örneğin; tork anahtarı ile sıkmak, motor tahrikli sıkma işlemleri, ultrason ile sıkmak gibi. Çeşitli uygulamalar tork anahtarı kullanımının daha makul olduğunu göstermiştir.

» As you know, force is the effect which imparts movement to an object. Torque, is rotation of an object under effect of force. Various hand tools like a Philips head screwdriver, for spanner or socket wrench are used to tighten connection elements. While this process appears functional and correct, it is not an appropriate procedure for reliability of the threaded connection. The greatest safety of a threaded connection against loosening is being tightened at a certain torque level theoretically calculated beforehand. This can only be ensured with various modern methods. For example, tightening with a torque wrench, motor-driven tightening or ultrasound supported tightening. Various applications have shown that use of a torque wrench is more appropriate.



### Sıkma Torku Nedir ?

» Sıkma torku, kuvvet etkisiyle döndürme kolunun uç kısmındaki anahtar ağzında oluşturulur ve birimi Nm'dir. Bu sıkma torku vida bağlantısında bir ön gerilme yaratır. Sıkma torkunun olması gerekenden düşük olması, zamanla oluşabilecek titreşimler sebebiyle vida-civata bağlantısında gevşeme/çözülmeye yol açabilir. Ön gerilme kuvveti fazlaca oluşan bağlantılarda ise parçalara zarar verebilir, aynı zamanda vida üzerindeki dişlerde meydana gelecek aşınmalar bağlantıyı çözülemez kılabilir.

### What is Tightening Torque ?

» Tightening torque is generated at the wrench tip at the terminus of the rotating lever under the effect of force, and its unit is Nm. This tightening torque creates a pre-tension on the threaded connection. Tightening torque being lower than what is necessary can cause the threaded connection to loosen/unravel due to vibrations that might occur over time. On the other hand, pre-tension force being over what is necessary can cause damage on the connection parts, as well as causing the threads on the connection piece to wear off or causing the connection become non-severable.

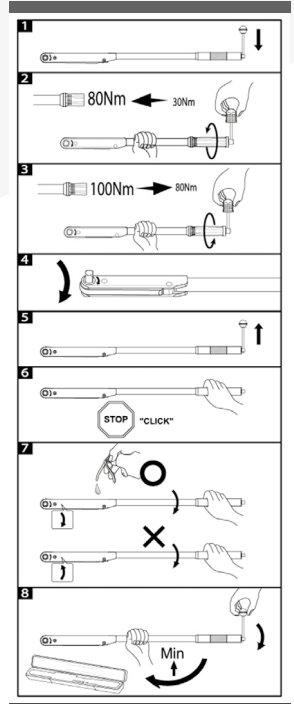



## Tork Anahtarlarının Doğru Kullanımı

- » Tork anahtarı ile çalışılırken dikkat edilmesi gereken bazı hususlar bulunmaktadır. Bunlardan başlıcaları;
- Hangi tip tork anahtarı olursa olsun döndürme yönünün aksine kuvvet uygulanmaması gereklidir.
  - Cırcır anahtarlar gibi tork anahtarlarının da sökme işlemi için kullanılmaması gerekir.
  - Klik sesli modellerde klik sesi duyulduğu anda ayarlanmış tork değerine ulaşılmış demektir, daha fazla kuvvet uygulanmamalıdır.
  - Gövdesi hasar görmüş, mekanizması bozulmuş tork anahtarlarını kullanmaya devam etmeyiniz.
  - Kuvvet, tork anahtarının sap kısmından uygulanmalıdır.
  - Kullanımdan sonra nemden ve kirden korumak için her zaman kutusunda muhafaza ediniz.
  - Her kullanımdan sonra tork anahtarındaki yükü "0 Nm" konumuna getiriniz.
  - Tork anahtarlarını kendi başınıza tamir etmeye çalışmayınız.



## Tork Anahtarlarının Kalibrasyonu

- » Tork anahtarlarının doğru çalışması ve bağlantıların sağlıklı sıkılabilmesi için kalibrasyon işlemi büyük önem arz etmektedir. TS EN ISO 6789-1 Standardına göre tork anahtarlarının ilk kullanımdan itibaren geçerli olmak üzere 12 aylık bir periyotta veya her 5000 kullanımlık çevrim sonunda kalibre edilmesi önerilmektedir.

## Calibration Of Torque Wrenches

- » Calibration process carries great importance for torque wrenches to function correctly and be able to tighten connections in a healthy fashion. TS EN ISO 6789-1 Standard stipulates torque wrenches should be calibrated with 12 month periods or after each cycle of 5000 uses starting from the first use.

## Correct Use Of Torque Wrenches

- » There are some important points that must be kept in mind when working with a torque wrench. Some of these include the following.
- No matter which type of torque wrench is used, force should not be applied at the opposite of rotating direction.
  - Torque wrenches like ratchet wrenches should not be used to loosen connections.
  - In models with click sound option, the click indicates the set torque value is achieved and further force should not be applied from then on.
  - Do not continue using torque wrenches with a damaged body or mechanism.
  - Force should be applied at the handle part of the torque wrench.
  - The tool should always be kept in its box after use to protect against moisture and dirt.
  - The load set of the torque wrench should be adjusted to "0 Nm" after each use.
  - Please do not attempt to repair torque wrenches on your own.

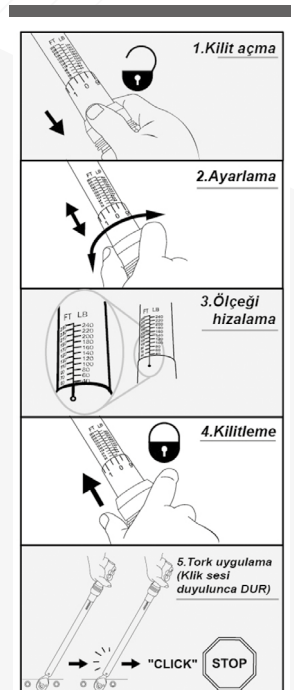

**Nikel üzeri krom kaplama ile korozyon direncinde üst seviye koruma**  
Corrosion protection with nickel over chrome plating

**Yüksek dayanım için üst toleranslarda tasarım**  
Improved durability with upper tolerance thickness

**En uygun temas yüzeyi için hassas dövülmüş altı köşe ağızlar**  
Precise forged hex shape for best contact area



**Bilya toplama yuvalı hassas işlenmiş kare kanal**  
Precise machined square adapter with ball stopper Groove

**Yüksek mukavemetli alaşımlı sıcak dövme çeliği**  
High strength alloyed forged steel

**Extra sürtünme kabiliyeti için tırtıklı tasarım**  
Extra friction capability with knurled design



1107

1/4" Altı Köşe Lokma Anahtar (mm)  
Socket Wrench 6 Points (mm)

TS ISO 2725 -1  
DIN 3124

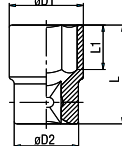

1/4"

Krom vanadyum, Krom kaplı  
Chrom vanadium, Chrom plated

KOD CODE	mm	ø D1 mm	ø D2 mm	L mm	L1 mm	g	TL/ Ad.
1107 06 0004	4	6.8	11.8	25	4	10	39,75
1107 06 0045	4.5	7.4	11.8	25	5	10	39,75
1107 06 0005	5	8	11.8	25	6	10	39,75
1107 06 0055	5.5	8.5	11.8	25	6	10	39,75
1107 06 0006	6	9.2	11.8	25	7	10	39,75
1107 06 0007	7	10.8	11.8	25	7	10	39,75
1107 06 0008	8	11.9	11.8	25	8	10	39,75
1107 06 0009	9	12.9	12.8	25	8	15	42,00
1107 06 0010	10	14.3	14.3	25	9	20	42,00
1107 06 0011	11	15.8	15.8	25	9	20	53,00
1107 06 0012	12	16.8	16.8	25	9	25	53,00
1107 06 0013	13	17.8	17.8	25	9	30	61,25

1107

1/4" Altı Köşe Derin Lokma Anahtar (mm)  
Deep Socket Wrench 6 Points (mm)

TS ISO 2725 -1

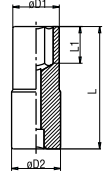

1/4"

Krom vanadyum, Krom kaplı  
Chrom vanadium, Chrom Plated

KOD CODE	mm	ø D1 mm	ø D2 mm	L mm	L1 mm	g	TL/ Ad.
1107 06 4004	4	6.8	11.8	50	6	10	74,50
1107 06 4005	5	8	11.8	50	7	20	74,50
1107 06 4055	5.5	8.7	11.8	50	9	20	74,50
1107 06 4006	6	9.2	11.8	50	9	25	84,00
1107 06 4007	7	10.8	11.8	50	15	25	84,00
1107 06 4008	8	11.8	11.8	50	15	25	84,00
1107 06 4009	9	13	13	50	15	30	90,00
1107 06 4010	10	14.5	14.5	50	15	40	90,00
1107 06 4011	11	15.8	15.8	50	21	45	96,00
1107 06 4012	12	16.8	16.8	50	21	50	96,00
1107 06 4013	13	17.8	17.8	50	21	55	96,00

1107 00 6014

1/4" Altı Köşe Derin Lokma Anahtar Set (14 parça, mm)  
Deep Socket Wrench Set Type 6 Points (14 pcs, mm)



1/4"

KOD CODE	LOKMA LAR Sockets	AVADAN LIKLAR Accessories	g	TL/Ad.
1107 00 6014	4-5-5,5-6 7-8-9-10 11-12-13 Altı Köşe Derin Lokma Wrench 6 Points	1/4" Cırcır Kol Ratchet Handle  1/4" Ara Kol Extension Bar 50 mm  1/4" Ara Kol Extension Bar 100 mm	1005	14 1.840,25





1107

**1/4" Lokmalı Allen Uç**  
Hexagonal Bit Socket Wrench



1/4"

Krom vanadyum, Krom Kaplı  
Chrom vanadium, Chrom Plated

KOD CODE	mm	L mm	g		TL/ Ad.
1107 06 1125	2.5	37	13	10	66,00
1107 06 1103	3	37	13	10	66,00
1107 06 1104	4	37	15	10	66,00
1107 06 1105	5	37	15	10	66,00
1107 06 1106	6	37	15	10	66,00
1107 06 1107	7	37	16	10	78,00
1107 06 1108	8	37	17	10	78,00
1107 06 1110	10	37	19	10	92,50

1107

**1/4" Lokmalı Star Delikli (Torx®) Uç**  
Tamper Resistant Torx Bit Socket Wrench



1/4"

Krom vanadyum, Krom Kaplı  
Chrom vanadium, Chrom Plated

KOD CODE		L mm	g		TL/ Ad.
1107 06 1308	TR8	37	13	10	79,25
1107 06 1309	TR9	37	13	10	79,25
1107 06 1310	TR10	37	13	10	79,25
1107 06 1315	TR15	37	14	10	79,25
1107 06 1320	TR20	37	14	10	79,25
1107 06 1325	TR25	37	14	10	79,25
1107 06 1327	TR27	37	14	10	79,25
1107 06 1330	TR30	37	15	10	79,25
1107 06 1340	TR40	37	16	10	91,25

1107

**1/4" Lokmalı Star (Torx®) Uç**  
Torx Bit Socket Wrench



1/4"

Krom vanadyum, Krom Kaplı  
Chrom vanadium, Chrom Plated

KOD CODE		L mm	g		TL/ Ad.
1107 06 1208	T8	37	12	10	68,50
1107 06 1209	T9	37	12	10	68,50
1107 06 1210	T10	37	13	10	68,50
1107 06 1215	T15	37	14	10	68,50
1107 06 1220	T20	37	14	10	68,50
1107 06 1225	T25	37	14	10	68,50
1107 06 1227	T27	37	14	10	68,50
1107 06 1230	T30	37	15	10	68,50
1107 06 1240	T40	37	16	10	68,50

1107

**1/4" Lokmalı Düz Uç**  
Slotted Bit Socket Wrench



1/4"

Krom vanadyum, Krom Kaplı  
Chrom vanadium, Chrom Plated

KOD CODE		L mm	g		TL/ Ad.
1107 06 1403	3	37	13	10	66,00
1107 06 1435	3.5	37	14	10	66,00
1107 06 1404	4	37	14	10	66,00
1107 06 1445	4.5	37	14	10	66,00
1107 06 1455	5.5	37	15	10	66,00
1107 06 1465	6.5	37	15	10	66,00
1107 06 1407	7	37	16	10	66,00
1107 06 1408	8	37	16	10	85,25
1107 06 1410	10	37	17	10	91,25

**1107**
**1/4" Lokmalı Yıldız Uç**  
**Phillips Bit Socket Wrench**

**1/4"**
**Krom vanadyum, Krom Kaplı**  
**Chrom vanadium, Chrom Plated**

KOD CODE	+	L mm	g	□	TL/Ad.
1107 06 1501	Ph 1	37	14	10	66,00
1107 06 1502	Ph 2	37	14	10	66,00
1107 06 1503	Ph 3	37	15	10	66,00
1107 06 1504	Ph 4	37	16	10	66,00

**1107 00 1042**
**1/4" Bits Uçlu Lokma Set (42 Parça)**  
**Bit Socket Wrench Set (42 Pcs)**

**1/4"**

KOD CODE	İÇERİK CONTENTS	□	TL/Ad.
1107 00 1042	1/4" Lokmalı Star Torx® Uçlar Torx® Bit Socket T8-T9-T10-T15-T20-T25-T27-T30-T40	42	3.827,50
	1/4" Lokmalı Star Delikli Torx® Uçlar Tamper Resistant Torx® Bit Socket Wrench TR8-TR9-TR10-TR15-TR20-TR25-TR27 TR30-TR40		
	1/4" Lokmalı Allen Uçlar Hexagonal Bit Socket Wrench 2.5-3-4-5-6-7-8-10		
	1/4" Lokmalı Düz Uç Slotted Bit Socket Wrench 3-3.5-4-4.5-5.5 6.5-7-8-10		
	1/4" Lokmalı Yıldız Uç Phillips Bit Socket Wrench Ph1-Ph2-Ph3-Ph4		
	1/4" Cırcır kolu Ratchet Handle		
	1/4" Ara Kol Extension Bar 100 mm		
1/4" Lokma Tornavida Adaptörü Spindle Handle			

**1507**
**1/4" Ara Kol**  
**Extension Bar**

 TS ISO 1174-1  
 TS ISO 3316  
 DIN 3123

**1/4"**
**Krom vanadyum, Krom kaplı**  
**Chrom vanadium, Chrom plated**

KOD CODE	L mm	g	□	TL/Ad.
1507 06 0050	50	25	5	98,50
1507 06 0100	100	45	5	105,75

**1507 06 3150**
**1/4" Ara Kol Flexible**  
**Flexible Extension**

**1/4"**
**Krom vanadyum, Krom kaplı**  
**Chrom vanadium, Chrom plated**

KOD CODE	L mm	g	□	TL/Ad.
1507 06 3150	150	70	5	428,50

**1507 06 0038**
**1/4" Mafsal**  
**Universal Joint**

 TS ISO 1174-1  
 DIN 3123

**1/4"**
**Krom vanadyum, Krom kaplı**  
**Chrom vanadium, Chrom plated**

KOD CODE	L mm	g	□	TL/Ad.
1507 06 0038	38	25	5	179,00

**1507 06 4115**
**1/4" T Kol**  
**Sliding T - Handle**

 TS ISO 3315  
 DIN 3122

**1/4"**
**Krom vanadyum, Krom kaplı**  
**Chrom vanadium, Chrom plated**

KOD CODE	L mm	g	□	TL/Ad.
1507 06 4115	115	45	5	175,25

1507 06 2140

1/4" Cırcır Kolu (45 Diş)  
Ratchet Handle (45 Teeth)

TS ISO 3315



1/4"

Krom vanadyum, Krom kaplı  
Chrom vanadium, Chrom plated

KOD CODE	L mm	g		TL/Ad.
1507 06 2140	140	140	5	692,50

1507 06 6140

1/4" Mandallı Cırcır Kolu (24 Diş)  
Ratchet With Latch (24 Teeth)

TS ISO 3315



1/4"

Krom vanadyum, Krom kaplı  
Chrom vanadium, Chrom plated

KOD CODE	L mm	g		TL/Ad.
1507 06 6140	140	140	5	991,25

1507 06 2150

1/4" Mafsallı Cırcır Kolu (72 Diş)  
Swivel Head Ratchet (72 Teeth)



1/4"

Krom vanadyum, Krom kaplı  
Chrom vanadium, Chrom plated

KOD CODE	L mm	g		TL/Ad.
★ 1507 06 2150	150	130	5	2.295,75

1507 06 2110

1/4" Lokma/Bits Tutuculu Cırcır Kolu (72 Diş)  
Socket/Bit Holder mini Ratchet (72 Teeth)



1/4"

Krom vanadyum, Krom kaplı  
Chrom vanadium, Chrom plated

KOD CODE	L mm	g		TL/Ad.
★ 1507 06 2110	110	100	5	1.441,25

1507 06 7115

1/4" Mafsallı T Kol Cırcır Kolu (72 Diş)  
Swivel Head, T Handle Ratchet (72 Teeth)

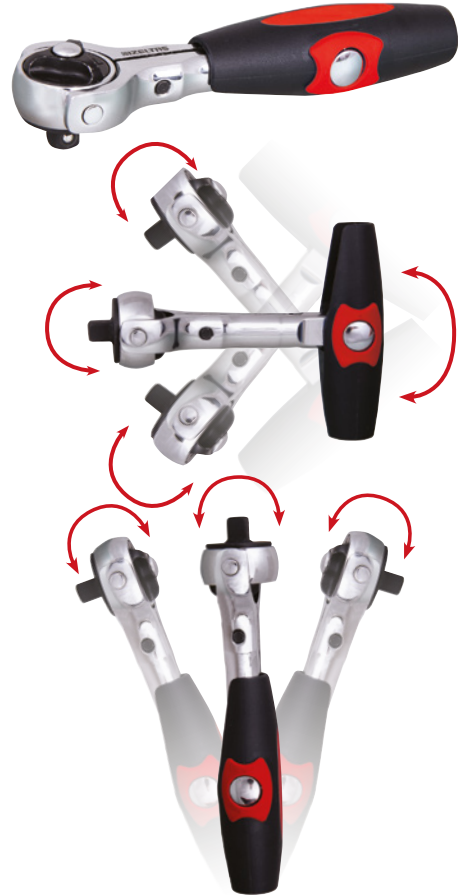

1/4"

Krom vanadyum, Krom kaplı  
Chrom vanadium, Chrom plated

KOD CODE	L mm	g		TL/Ad.
★ 1507 06 7115	115	110	5	2.205,75



1507 06 0004

1/4" Lokma Adaptörü  
Adapter

TS ISO 3316  
DIN 3123



1/4"

Krom vanadyum, Krom kaplı  
Chrom vanadium, Chrom plated

KOD CODE	inch	g		TL/Ad.
1507 06 0004	1/4"Fx3/8"M	20	5	90,00

1507 06 4080

1/4" Derin Lokma Tornavida Adaptörü  
Spindle Handle

TS ISO 3315  
DIN 3122

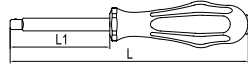

1/4"

Krom vanadyum, Krom kaplı, Selüloz Asetat Saplı  
Chrom vanadium, Chrom plated, Cellulose Acetate Handle

KOD CODE	L mm	L1 mm	g		TL/Ad.
1507 06 4080	150	65	100	10	206,50

1107 06 5010

1/4" Bits Tutucu Lokma (Mıknatıslı)  
Bit Holder Socket



1/4"

Krom vanadyum  
Chrom vanadium

KOD CODE	Inch	g		TL/Ad.
1107 06 5010	1/4" F - 1/4" F	15	5	144,00

1107 00 6015

1/4" Altı Köşe Lokma Anahtar Takımı (15 parça, mm)  
Socket Wrench Set 6 Points (15 pcs, mm)



1/4"

KOD CODE	LOKMALAR Sockets	AVADANLIKLAR Accessories	g		TL/Ad.
1107 00 6015	4 - 5 - 6	1/4" Cırcır kolu Ratchet Handle	960	15	1.701,00
	7 - 8 - 9 - 10 11 - 12 - 13 Altı Köşe Six Points	1/4" Mafsalsal Universal Joint 1/4" T Kol Sliding T Handle 1/4" Ara Kol Extension Bar 50 mm 1/4" Ara Kol Extension Bar 100 mm			



14000 005131

**1/4" Altı Köşe Lokma Anahtar ve Bits Set (48 parça, mm)**  
Socket Wrench 6 Points and Bits Set (48 Pcs, mm)

YENİ  
NEW



1/4"

KOD CODE	LOKMALAR Sockets	AVADANLIKLAR Accessories	g	TL/Ad.
14000 005131	4 - 4.5 - 5 5.5 - 6 - 7 - 8 9 - 10 - 11 - 12 13 - 14 Altı Köşe Lokma Anahtar Six Points	1/4" Cırcır kolu Ratchet Handle 1/4" Mafsalsal Universal Joint 1/4" Ara Kol Extension Bar 50 -100 mm 1/4" Bits Tutucu Lokma Bits Holder Socket 1/4" Derin Lokma Tornavida Adaptörü Spindle Handle	1450 48	4.491,75
		SL3 - SL4,5 - SL5 SL6.5 - SL8 PH0 - PH1 - PH2 PH3 H3 - H4 - H5 - H6 H7 - H8 - H10		

14000 005132

**1/4" Altı Köşe Lokma Anahtar ve Bits Set (27 parça, mm)**  
Socket Wrench 6 Points and Bits Set (27 Pcs, mm)

YENİ  
NEW

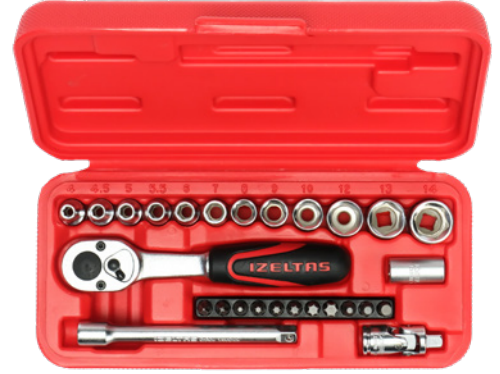

1/4"

KOD CODE	LOKMALAR Sockets	AVADANLIKLAR Accessories	g	TL/Ad.
14000 005132	4 - 4.5 - 5 5.5 - 6 - 7 - 8 9 - 10 - 12 13 - 14 Altı Köşe Lokma Anahtar Six Points	1/4" Cırcır Kolu Ratchet Handle 1/4" Mafsalsal Universal Joint 1/4" Ara Kol Extension Bar 100 mm 1/4" Bits Tutucu Lokma Bits Holder Socket	590 27	1.957,25
		PH1 - PH2 H3 - H4 - H5 T10 - T15 - T20 T25 - T30 - T40		

14000 005133

**1/4" Altı Köşe Lokma Anahtar ve Bits Set (45 parça, mm)**  
Socket Wrench 6 Points and Bits Set (45 Pcs, mm)

YENİ  
NEW



1/4"

KOD CODE	LOKMALAR Sockets	AVADANLIKLAR Accessories	g	TL/Ad.
14000 005133	4 - 5 5.5 - 6 - 7 - 8 9 - 10 - 11 - 12 13 - 14 Altı Köşe Lokma Anahtar Six Points	1/4" Cırcır kolu Ratchet Handle 1/4" Mafsalsal Universal Joint 1/4" Ara Kol Extension Bar 50 mm 1/4" Bits Tutucu Lokma Bits Holder Socket 1/4" Derin Lokma Tornavida Adaptörü Spindle Handle 1/4" Arakol Flexible Flexible Extension	1000 45	2.873,00
		SL4.5 - SL6.5 SL7 - SL8 PH1 - PH2 - PH3 PZ1 - PZ2 - PZ3 H2.5 - H3 - H4 - H5 H6 - H7 - H8 - H10 T8U - T9U - T10U T15U - T20U - T25U T27U - T30U - T40U		

Havali aletler ile kullanmayınız / Do not use with power-tools

1110

**3/8" Altı Köşe Lokma Anahtar (mm)**  
Socket Wrench 6 Points (mm)

TS ISO 2725 - 1  
DIN 3124

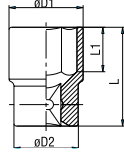

3/8"

**Krom vanadyum, Krom kaplı**  
Chrom vanadium, Chrom plated

KOD CODE	mm	ø D1 mm	ø D2 mm	L mm	L1 mm	g	TL/Ad.
1110 06 0006	6	9.8	17.8	27	9	25	10 99,75
1110 06 0007	7	10.8	17.8	27	9	25	10 99,75
1110 06 0008	8	12	17.8	27	9	25	10 99,75
1110 06 0009	9	13.2	17.8	27	9	25	10 99,75
1110 06 0010	10	14.5	17.8	27	9	25	10 99,75
1110 06 0011	11	15.8	17.8	27	9	30	10 99,75
1110 06 0012	12	16.8	17.8	27	9	30	10 99,75
1110 06 0013	13	17.8	16.8	27	9	30	10 105,75
1110 06 0014	14	19.6	17.5	29	11	35	10 105,75
1110 06 0015	15	20.8	18	29	11	45	10 105,75
1110 06 0016	16	21.8	19	29	11	45	10 110,50
1110 06 0017	17	23.4	20	29	11	55	10 110,50
1110 06 0018	18	24.7	21	29	13	60	10 115,25
1110 06 0019	19	25.8	22	29	13	65	10 132,00
1110 06 0021	21	27.8	24	32	13	80	10 149,00
1110 06 0022	22	29.7	26	32	15	85	10 159,75
1110 06 0023	23	29.7	26	32	15	90	10 159,75

1110 06 9208

**3/8" Buji Lokma Anahtar (Lastikli)**  
Spark Plug Socket with Rubber



3/8"

**Krom vanadyum, Krom kaplı**  
Chrom vanadium, Chrom plated

KOD CODE	mm	L mm	g	TL/Ad.
1110 06 9208	20.8	70	145	10 211,25

**3/8" Altı Köşe Derin Lokma Anahtar (mm)**  
Deep Socket Wrench 6 Points (mm)

TS ISO 2725 - 1  
DIN 3124



3/8"

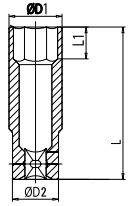

**Krom vanadyum, Krom kaplı**  
Chrom vanadium, Chrom plated

KOD CODE	mm	ø D1 mm	ø D2 mm	L mm	L1 mm	g	TL/Ad.
14000 004965	6	9.9	17.8	63	10	50	10 185,00
14000 004966	7	10.8	17.8	63	12	50	10 185,00
14000 004967	8	12	17.8	63	12	50	10 185,00
14000 004968	9	13.2	17.8	63	12	55	10 185,00
14000 004969	10	14.5	17.8	63	12	60	10 185,00
14000 004970	11	15.8	17.8	63	15	60	10 185,00
14000 004971	12	16.8	17.8	63	15	70	10 185,00
14000 004972	13	17.8	16.8	63	15	65	10 191,00
14000 004973	14	19.7	18	63	16	80	10 191,00
14000 004974	15	20.8	18	63	18	75	10 191,00
14000 004975	16	21.8	19	63	18	85	10 191,00
14000 004976	17	23.8	20	63	18	100	10 255,75
14000 004977	18	24.7	21	63	20	110	10 255,75
14000 004978	19	25.8	21	63	20	110	10 261,75
14000 004980	21	27.8	25	63	20	140	10 299,00
14000 004981	22	29.7	26	63	20	170	10 353,00

**3/8" Star (Torx®) Lokma Anahtar**  
Star Torx® Socket Wrench



3/8"

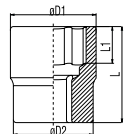

**Krom vanadyum, Krom kaplı**  
Chrom vanadium, Chrom plated

KOD CODE	mm	ø D1 mm	ø D2 mm	L mm	L1 mm	g	TL/Ad.
14000 005001	E4	6	16.8	28	3.6	20	10 140,50
14000 005002	E5	7	16.8	28	4	20	10 140,50
14000 005003	E6	8	16.8	28	5	20	10 140,50
14000 005004	E7	9	16.8	28	6	20	10 140,50
14000 005005	E8	10	16.8	28	6.5	25	10 140,50
14000 005006	E10	12	16.8	28	7	25	10 140,50
14000 005007	E11	12.8	16.8	28	8	25	10 140,50
14000 005008	E12	14.3	16.8	28	9	25	10 140,50
14000 005009	E14	15.9	17.8	28	9.5	30	10 140,50
14000 005010	E16	18	19.8	28	10.5	40	10 145,25
14000 005011	E18	20	21.8	28	11	55	10 150,00



**3/8" Lokmalı Allen Uç (mm)**  
Hexagonal Bits Socket Wrench



**3/8"**

Krom vanadyum, Krom kaplı  
Chrom vanadium, Chrom plated

KOD CODE	mm	L mm	g		TL/ Ad.
14000 004993	3	50	30	10	176,50
14000 004994	4	50	35	10	176,50
14000 004995	5	50	35	10	176,50
14000 004996	6	50	35	10	176,50
14000 004997	7	50	40	10	191,00
14000 004998	8	50	40	10	191,00
14000 004999	9	50	45	10	223,25
14000 005000	10	50	50	10	223,25

**3/8" Lokmalı Star (Torx®) Uç**  
Star Torx® Bits Socket Wrench



**3/8"**

Krom vanadyum, Krom kaplı  
Chrom vanadium, Chrom plated

KOD CODE		L mm	g		TL/ Ad.
14000 004983	T8	50	30	10	156,00
14000 004984	T9	50	30	10	156,00
14000 004985	T10	50	35	10	176,50
14000 004986	T15	50	35	10	176,50
14000 004987	T20	50	35	10	176,50
14000 004988	T25	50	35	10	176,50
14000 004989	T27	50	35	10	176,50
14000 004990	T30	50	35	10	176,50
14000 004991	T40	50	35	10	176,50
14000 004992	T45	50	40	10	201,75

Havali aletler ile kullanmayınız / Do not use with power-tools

**1510 06 0200**

**3/8" Cırcır Kolu (32 Diş)**  
Ratchet Handle (32 Teeth)

TS ISO 3315  
DIN 3122



**3/8"**

Krom vanadyum, Krom kaplı  
Chrom vanadium, Chrom plated

KOD CODE	L mm	g		TL/ Ad.
1510 06 0200	200	295	5	1.172,50

**1510**

**3/8" Ara Kol**  
Extension Bar

TS ISO 1174-1  
TS ISO 3316  
DIN 3123



**3/8"**

Krom vanadyum, Krom kaplı  
Chrom vanadium, Chrom plated

KOD CODE	L mm	g		TL/Ad.
1510 06 0075	75	75	5	179,00
1510 06 0150	150	145	5	270,00

**1510 06 0056**

**3/8" Mafsal**  
Universal Joint

TS ISO 3316  
DIN 3123



**3/8"**

Krom vanadyum, Krom kaplı  
Chrom vanadium, Chrom plated

KOD CODE	L mm	g		TL/ Ad.
1510 06 0056	56.5	60	5	289,25

**1510 06 1200**
**3/8" T Kol**  
Sliding T - Handle

 TS ISO 3315  
DIN 3122

**3/8"**

 Krom vanadyum, Krom kaplı  
Chrom vanadium, Chrom plated

KOD CODE	L mm	g		TL/Ad.
1510 06 1200	200	180	5	416,50

**1510 06 0007**
**3/8" Lokma Adaptörü**  
Adapter

 TS ISO 3316  
DIN 3123

**3/8"**

 Krom vanadyum, Krom kaplı  
Chrom vanadium, Chrom plated

KOD CODE	inch	g		TL/Ad.
1510 06 0007	3/8"Fx1/2"M	45	5	199,25

**1110 00 6019**
**3/8" Altı Köşe Lokma Anahtar Takımı (19 parça, mm)**  
6 Points Socket Wrench Set (19 Pcs, mm)

**3/8"**

KOD CODE	LOKMALAR Sockets	AVADANLIKLAR Accessories	g		TL/Ad.
1110 00 6019	6 - 7 - 8 - 9 10 - 11 - 12 13 - 14 - 17 19 - 21 - 23 Altı Köşe Six Points 20.8 Buji Lokma Lastikli Altı Köşe Spark Plug Socket With Rubber	3/8" Cırcır Kolu Ratchet Handle 3/8" Mafsal Universal Joint 3/8" T Kol Sliding T Handle 3/8" Ara Kol Extension Bar 75 mm 3/8" Ara Kol Extension Bar 150 mm	1089	19	3.999,50

**14000 005134**
**3/8" Altı Köşe Lokma Anahtar Set (24 parça, mm)**  
Socket Wrench Set 6 Points (24 Pcs, mm)

**YENİ NEW**

**3/8"**

KOD CODE	LOKMALAR Sockets	AVADANLIKLAR Accessories	g		TL/Ad.
14000 005134	7 - 8 - 9 10 - 11 - 12 13 - 14 - 15 16 - 17 - 19 Altı Köşe Six Points 8 - 10 - 11 12 - 13 - 14 16 - 17 - 19 Altı Köşe Derin Six Points Deep	3/8" Cırcır Kolu Ratchet Handle 3/8" Mafsal Universal Joint 3/8" Ara Kol Extension Bar 75 mm	2010	24	5.195,00

**14000 005135**
**3/8" Altı Köşe Lokma Anahtar & Lokmalı Allen Set (35 parça, mm)**  
Socket Wrench Set 6 Points and Hexagonal Bit Socket Wrench Set (35 Pcs, mm)

**YENİ NEW**

**3/8"**

KOD CODE	LOKMALAR Sockets	AVADANLIKLAR Accessories	g		TL/Ad.
14000 005135	6 - 7 - 8 - 9 10 - 11 - 13 14 - 17 - 19 Altı Köşe Six Points E4 - E5 - E6 E7 - E8 - E10 E12 - E14 - E16 E18 Star (Torx) Lokma Anahtar Torx Socket Wrench	3/8" Cırcır Kolu Ratchet Handle 3/8" Mafsal Universal Joint 3/8" Ara Kol Extension Bar 75 mm - 150 mm 3/8" T Kol Sliding T Handle H3 - H4 - H5 - H6 - H8 Lokma Allen Uç Hexagonal Bit Socket T20 - T25 - T27 T30 - T40 Lokmalı Star (Torx®) Uç	2240	35	4.688,50

Havalı aletler ile kullanmayınız / Do not use with power-tools

1113 00 6145

## 1/2" Lokma Anahtar Sehpası (145 Parça) Display Frame for Sockets (145 Pcs)

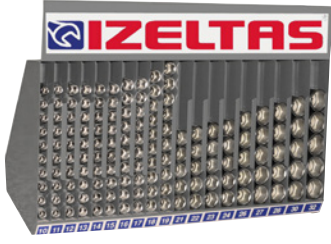

1/2"

KOD CODE	İÇERİK CONTENTS	g	□	TL/Ad.
1113 00 6145	Dolu/Full 10-11-12-13-14-15-16-17-18-19 10 adet / 10 Pcs 21-22-23-24-26-27-28-30-32 5 Adet / 5 Pcs	18.240	1	29.571,50

1113

## 1/2" Altı Köşe Lokma Anahtar (mm) Socket Wrench 6 Points (mm)



1/2"



TS ISO 2725 -1  
DIN 3124

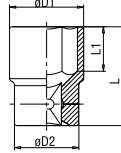

Krom vanadyum, Krom kaplı  
Chrom vanadium, Chrom plated

KOD CODE	mm	σ D1 mm	σ D2 mm	L mm	L1 mm	g	□	TL/Ad.
1113 06 1008	8	14	22	38	7	55	10	127,25
1113 06 1009	9	14.1	22	38	7	55	10	127,25
1113 06 1010	10	15.4	22	38	8	55	10	157,25
1113 06 1011	11	16.6	22	38	8	60	10	157,25
1113 06 1012	12	17.8	22	38	9	60	10	157,25
1113 06 1013	13	19	22	38	10	65	10	169,25
1113 06 1014	14	20.4	22	38	11	65	10	169,25
1113 06 1015	15	21.6	22	38	11	65	10	169,25
1113 06 1016	16	22.9	22	38	11	70	10	177,75
1113 06 1017	17	24	22	38	12	70	10	177,75
1113 06 1018	18	25.4	23	38	13	75	10	177,75
1113 06 1019	19	26.6	23	38	13	75	10	185,00
1113 06 1020	20	28	24	38	13	80	10	185,00
1113 06 1021	21	29.2	24	38	13	85	5	185,00
1113 06 1022	22	30.4	26	38	15	95	5	185,00
1113 06 1023	23	31.2	28	38	15	100	5	193,25
1113 06 1024	24	32.9	28	38	17	115	5	193,25
1113 06 1025	25	33.2	29	42	17	125	5	193,25
1113 06 1026	26	34	30	42	17	135	5	193,25
1113 06 1027	27	36.6	30	42	19	140	5	221,00
1113 06 1028	28	37.5	30	42	20	160	5	221,00
1113 06 1029	29	39.5	32	42	21	170	5	233,00
1113 06 1030	30	40	32	44	21	180	5	233,00
1113 06 1032	32	43	34	44	23	190	5	241,25

Havali aletler ile kullanmayınız / Do not use with power-tools

## 1000V 1/2" Altı Köşe Lokma Anahtar (mm) Socket Wrench 6 Points 1000V (mm)

TS ISO 2725 -1  
DIN 3124  
△ 1000 V  
IEC 60900

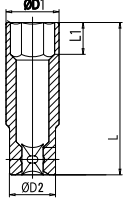

1/2"

Krom vanadyum, Krom kaplı  
Chrom vanadium, Chrom plated

KOD CODE	mm	σ D1 mm	σ D2 mm	L mm	L1 mm	g	□	TL/Ad.
13000 005148	10	19.5	27	40	7	55	1	659,00
13000 005149	11	20.7	27	40	7	55	1	655,25
13000 005150	12	22	27	40	8	55	1	667,25
13000 005151	13	23.2	27	40	8	60	1	669,75
13000 005152	14	24.5	27	40	9	60	1	674,50
13000 005153	15	25.7	27	40	10	65	1	678,00
13000 005154	16	27	27	40	11	65	1	691,25
13000 005155	17	28.2	27	40	11	65	1	701,00
13000 005156	19	30.7	27	42	11	70	1	715,25
13000 005157	22	34.5	27	44	12	70	1	733,25
13000 005158	24	37	27	46	13	75	1	747,75
13000 005159	27	40.7	27	48	13	75	1	882,00

1113

## 1/2" Buji Lokma Anahtar (Lastikli) Spark Plug Socket with Rubber



1/2"

Krom vanadyum, Krom kaplı  
Chrom vanadium, Chrom plated

KOD CODE	mm	L mm	g	□	TL/Ad.
1113 06 9160	16	70	80	10	227,00
1113 06 9208	21	70	155	10	293,00



**1114**
**1/2" Oniki Köşe Lokma Anahtar (mm)**  
 Socket Wrench 12 Points (mm)

 TS ISO 2725 - 1  
 DIN 3124

**1/2"**

 Krom vanadyum, Krom kaplı  
 Chrom vanadium, Chrom plated

KOD CODE	Ø mm	σ D1 mm	σ D2 mm	L mm	L1 mm	g	TL/Ad.
1114 06 1010	10	15	23.3	38	8	60	10 158,50
1114 06 1011	11	16.4	23.3	38	8	60	10 158,50
1114 06 1012	12	17.8	23.3	38	9	60	10 158,50
1114 06 1013	13	19	23.3	38	10	60	10 170,50
1114 06 1014	14	20.4	23.3	38	11	60	10 170,50
1114 06 1015	15	21.6	23.3	38	11	65	10 170,50
1114 06 1016	16	22.9	24	38	11	70	10 177,75
1114 06 1017	17	24	22.5	38	12	70	10 177,75
1114 06 1018	18	25.2	23	38	13	70	10 177,75
1114 06 1019	19	26.8	23	38	13	75	10 186,00
1114 06 1020	20	28	23	38	13	80	10 186,00
1114 06 1021	21	29.2	23	38	13	80	5 186,00
1114 06 1022	22	30.2	24	40	15	95	5 186,00
1114 06 1023	23	31.4	25	40	15	100	5 193,25
1114 06 1024	24	32.6	26	42	17	105	5 193,25
1114 06 1026	26	35.3	28	42	17	135	5 218,50
1114 06 1027	27	36.6	28	42	19	135	5 249,75
1114 06 1028	28	37.8	30	42	20	155	5 249,75
1114 06 1030	30	40	30	44	21	165	5 261,75
1114 06 1032	32	42.5	30	44	23	180	5 273,75

**1413**
**1/2" Oniki Köşe Lokma Anahtar (SAE)**  
 Socket Wrench 12 Points (SAE)

**1/2"**

 Krom vanadyum, Krom kaplı  
 Chrom vanadium, Chrom plated

KOD CODE	Ø inch	σ D1 mm	σ D2 mm	L mm	L1 mm	g	TL/Ad.
1413 06 1008	5/16"	13.2	21.8	37	6	45	10 185,00
1413 06 1095	3/8"	15	21.8	37	8	50	10 185,00
1413 06 1010	7/16"	16.4	23.3	37	9	60	10 191,00
1413 06 1011	15/32"	18	23.3	37	9	60	10 191,00
1413 06 1012	1/2"	19	23.3	37	9	60	10 199,25
1413 06 1013	9/16"	20.4	23.3	37	11	60	10 205,25
1413 06 1014	19/32"	21.6	23.3	37	11	65	10 205,25
1413 06 1015	5/8"	23.1	22	38	11	70	10 207,75
1413 06 1016	11/16"	24.5	22.5	38	11	70	10 215,00
1413 06 1017	3/4"	26.8	23	38	13	75	10 217,25
1413 06 1020	25/32"	28	23	38	13	75	10 224,50
1413 06 1021	13/16"	28.6	23	38	13	80	10 224,50
1413 06 1022	7/8"	30.2	24	40	15	90	5 224,50
1413 06 1024	15/16"	32.6	26	42	17	115	5 234,00
1413 06 1025	1"	35	28	42	17	130	5 234,00
1413 06 1027	1 1/16"	36.6	28	42	19	135	5 306,00
1413 06 1029	1 1/8"	38.8	30	42	19	170	5 306,00
1413 06 1030	1 3/16"	40	29.5	44	20	170	5 306,00
1413 06 1032	1 1/4"	42.5	30	44	22	185	5 306,00

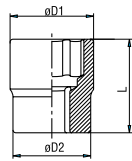
**14000 005130**
**1/2" Twist Lokma Anahtar Set (10 parça, mm)**  
 Twist Socket Wrench Set (10 Pcs,mm)

**1/2"**

 Krom molibden, Fosfat kaplamalı  
 Chrom molybdenum, Phosphate finish

KOD CODE	mm	σ D1 mm	σ D2 mm	L mm	Ad. Boy	g	TL/Ad.
	10	16	22	34	-		1
	11	17.5	22	34	-		1
	12	18.5	22	34	-		1
	13	20.4	22	34	-		1
	14	21.5	25	34	-		1
14000 005130	15	22.5	25	34	-	790	1 5.646,00
	16	23.5	25	34	-		1
	17	25.8	25	34	-		1
	19	28.7	27	34	-		1
	Adaptör / Adapter					80	1

**YENİ  
NEW**

Havalı aletler ile kullanmayınız / Do not use with power-tools

1108

1/2" Altı Köşe Derin Lokma Anahtar (mm)  
Deep Socket Wrench 6 Points (mm)

TS ISO 2725 - 1  
DIN 3124

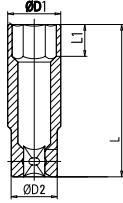

Krom vanadyum, Krom kaplı  
Chrom vanadium, Chrom plated

KOD CODE	mm	øD1 mm	øD2 mm	L mm	L1 mm	g	TL/ Ad.
1108 06 0010	10	15,2	22	75	6	110	10 294,00
1108 06 0011	11	16,7	24	75	7	110	10 294,00
1108 06 0012	12	18	24	75	8	110	10 294,00
1108 06 0013	13	19	24	75	8	120	10 315,75
1108 06 0014	14	20,5	24	75	10	120	10 315,75
1108 06 0015	15	21,7	24	75	10	140	10 315,75
1108 06 0016	16	22	25,5	75	10	140	10 330,00
1108 06 0017	17	24	25,5	75	10	140	10 330,00
1108 06 0018	18	25,5	25,5	75	12	150	10 330,00
1108 06 0019	19	26	26,7	75	12	150	10 345,75

1108 00 6010

1/2" Altı Köşe Derin Lokma Anahtar Takımı (10 parça mm)  
Deep Socket Wrench 6 Points (10 Pcs, mm)



KOD CODE	İÇERİK CONTENTS	g	TL/ Ad.
1108 00 6010	10-11-12-13-14-15 16-17-18-19	1290	10 3.165,00

1113

1/2" Star (Torx®) Lokma Anahtar  
Star Torx® Socket Wrench

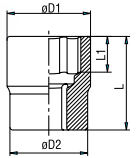

Krom vanadyum, Krom kaplı  
Chrom vanadium, Chrom plated

KOD CODE	mm	øD1 mm	øD2 mm	L mm	L1 mm	g	TL/ Ad.
1113 06 0210	E10	13,2	23,8	37	7,5	60	10 151,25
1113 06 0212	E12	15	23,8	37	9	65	10 151,25
1113 06 0214	E14	16,4	23,8	37	10	65	10 151,25
1113 06 0216	E16	18,8	23,8	37	11	70	10 151,25
1113 06 0218	E18	20,5	23,8	39	12,5	75	10 151,25
1113 06 0220	E20	23	23,8	39	14	75	10 170,50

1113 00 6007

1/2" Star (Torx®) Lokma Anahtar Takımı (7 Parça)  
Star Torx® Socket Wrench Set (7 Pcs)



KOD CODE	İÇERİK CONTENTS	g	TL/ Ad.
1113 00 6007	Star Lokma / Star Socket E10 - E12 - E14 - E16 - E18 - E20 125 mm Ara Kol / Extension Bar	1075	7 1.258,00

**1113**
**1/2" Lokmalı Allen Uç (mm)**  
 Hexagonal Bit Socket Wrench

**1/2"**

 Krom vanadyum, Krom kaplı  
 Chrom vanadium, Chrom plated

KOD CODE	mm	L mm	g		TL/Ad.
1113 06 1105	5	60	70	10	201,75
1113 06 1106	6	60	70	10	201,75
1113 06 1107	7	60	75	10	201,75
1113 06 1108	8	60	75	10	201,75
1113 06 1110	10	60	85	10	230,50
1113 06 1112	12	60	100	10	230,50
1113 06 1114	14	60	115	10	230,50
1113 06 4105	5	100	90	10	239,00
1113 06 4106	6	100	90	10	239,00
1113 06 4107	7	100	90	10	239,00
1113 06 4108	8	100	95	10	239,00
1113 06 4110	10	100	105	10	276,00
1113 06 4112	12	100	145	10	276,00
1113 06 4114	14	100	155	10	331,25
1113 06 4117	17	100	200	10	443,00

**1113**
**1/2" Lokmalı Star (Torx®) Uç**  
 Star (Torx) Bit Socket Wrench

**1/2"**

 Krom vanadyum, Krom kaplı  
 Chrom vanadium, Chrom plated

KOD CODE		L mm	g		TL/Ad.
1113 06 1220	T20	55	70	10	248,50
1113 06 1225	T25	55	70	10	248,50
1113 06 1227	T27	55	70	10	248,50
1113 06 1230	T30	55	70	10	248,50
1113 06 1240	T40	55	70	10	248,50
1113 06 1245	T45	55	70	10	248,50
1113 06 1250	T50	55	75	10	248,50
1113 06 1255	T55	55	80	10	248,50
1113 06 1260	T60	55	100	10	264,00
1113 06 4220	T20	100	78	10	281,00
1113 06 4225	T25	100	79	10	281,00
1113 06 4227	T27	100	80	10	281,00
1113 06 4230	T30	100	80	10	281,00
1113 06 4240	T40	100	80	10	281,00
1113 06 4245	T45	100	82	10	281,00
1113 06 4250	T50	100	82	10	281,00
1113 06 4255	T55	100	100	10	281,00
1113 06 4260	T60	100	134	10	291,75

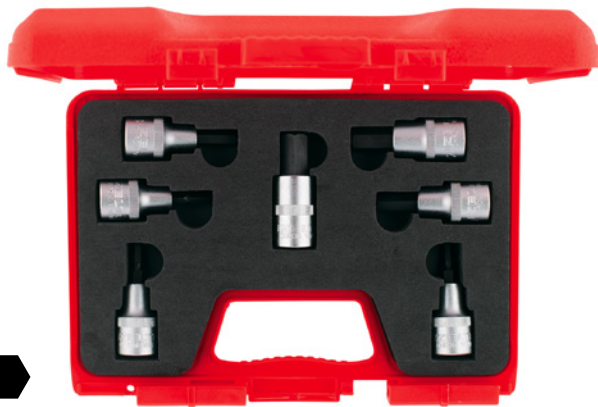
**1113 00 1107**
**1/2" Lokmalı Allen Uç Takımı (60 mm, 7 Parça)**  
 Hexagonal Bits Socket Wrench Set (60 mm, 7 Pcs)

**1/2"**

KOD CODE	İÇERİK CONTENTS	g		TL/Ad.
1113 00 1107	Allen Uçlar 60mm Hex Bit Socket 5-6-7-8-10-12-14	1040	7	1.498,50

**1113 00 6009**
**1/2" Lokmalı Star (Torx®) Uç Takımı (55 mm, 9 parça)**  
 Torx® Bits Socket Wrench Set (55 mm, 9 Pcs)

**1/2"**

KOD CODE	İÇERİK CONTENTS	g		TL/Ad.
1113 00 6009	Torx® Uçlar 55mm Star Socket T20 - T25 - T27 - T30 - T40 - T45 T50 - T55 - T60	1125	9	2.252,00



**1113 00 6017**
**1/2" Lokmalı Allen Uç ve Star (Torx®) Uç Takımı (17 Parça)**  
 Hex Bit Sockets - Torx Bit Sockets Set (17 Pcs)

**1/2"**

KOD CODE	İÇERİK CONTENTS	g		TL/Ad.
1113	T Kol (1/2") Sliding T Handle			
1113	5 - 6 - 7 - 8 - 10 - 12 - 14 Lokmalı Allen Uç 60mm Hex Bit Socket			
1113	T20 - T25 - T27 T30 - T40 T45 - T50 - T55 - T60 Lokmalı Star (Torx) Uç 55mm Torx Bit Socket		17	4.473,00

**1114**
**1/2" Oniki Köşe Lokmalı Bits Uç Yivli (XZN)**  
 Hex Bit Socket 12 Points (XZN)

**1/2"**

 Krom vanadyum, Krom kaplı  
 Chrom vanadium, Chrom plated

KOD CODE		L mm	g		TL/Ad.
1114 06 4005	M5	60	60	10	182,50
1114 06 4006	M6	60	62	10	182,50
1114 06 4008	M8	60	62	10	182,50
1114 06 4010	M10	60	78	10	182,50
1114 06 4012	M12	60	84	10	217,25
1114 06 4106	M6	80	69	10	230,50
1114 06 4108	M8	80	70	10	230,50
1114 06 4110	M10	80	84	10	254,50
1114 06 4112	M12	80	103	10	263,00
1114 06 4114	M14	80	133	10	281,00
1114 06 4208	M8	140	96	10	259,25
1114 06 4210	M10	140	125	10	317,00
1114 06 4212	M12	140	161	10	356,50
1114 06 4214	M14	140	210	10	401,00
1114 06 4216	M16	140	281	10	581,00

Havalı aletler ile kullanmayınız / Do not use with power-tools

**1114**
**1/2" Lokmalı Ribe Bits Uç**  
 Socket Wrench 6 Points

**1/2"**

 Krom vanadyum, Krom kaplı  
 Chrom vanadium, Chrom plated

KOD CODE		L mm	g		TL/Ad.
1114 06 5004	4	100	75	10	251,00
1114 06 5005	5	100	76	10	251,00
1114 06 5006	6	100	76	10	251,00
1114 06 5007	7	100	77	10	251,00
1114 06 5008	8	100	78	10	251,00
1114 06 5009	9	100	85	10	253,25
1114 06 5010	10	100	96	10	253,25
1114 06 5011	10.5	100	96	10	259,25
1114 06 5012	12	100	121	10	323,00
1114 06 5013	13	100	148	10	354,00
1114 06 5014	14	100	150	10	354,00
1114 06 5016	16	100	198	10	479,00

**1513 06 0032**
**1/2" Cırcır Kolu (32 Diş)**  
 Ratchet Handle (32 Teeth)

 TS ISO 3315  
 DIN3122

**1/2"**

 Krom vanadyum, Krom kaplı  
 Chrom vanadium, Chrom plated

KOD CODE	L mm	g		TL/Ad.
1513 06 0032	250	580	5	1.305,75

**13000 005277**
**1000V 1/2" Cırcır Kolu (36 Diş)**  
 Ratchet Handle 1000V (36 Teeth)

 1000 V  
 IEC 60900

**1/2"**

KOD CODE	L mm	g		TL/Ad.
13000 005277	275	540	1	6.356,50

**1513**
**1/2" Ara Kol**  
 Extension Bar

 TS ISO 3316  
 TS ISO 1174-1  
 DIN 3123

 ⚡ 1000 V  
 IEC 60900

**1/2"**

 Krom vanadyum, Krom kaplı  
 Chrom vanadium, Chrom plated

KOD CODE	L mm	g	□	TL/Ad.
1513 06 4075	75	140	5	296,50
1513 06 4125	125	215	5	331,25
1513 06 4250	250	420	5	503,00

**1000V 1/2" Ara Kol**  
 Extension Bar 1000V

 ⚡ 1000 V  
 IEC 60900

**1/2"**

 Krom vanadyum, Krom kaplı  
 Chrom vanadium, Chrom plated

KOD CODE	L mm	g	□	TL/Ad.
13000 005262	75	140	1	1.685,00
13000 005263	125	215	1	1.868,50
13000 005264	250	420	1	2.537,00

**1513 06 5250**
**1/2" T Kol Adaptörü**  
 Adapter

**1/2"**

 Krom vanadyum, Krom kaplı  
 Chrom vanadium, Chrom plated

KOD CODE	inch	g	□	TL/Ad.
1513 06 5250	3/8"Fx1/2"M	90	5	308,50

**1513 06 2250**
**1/2" T Kol**  
 Sliding T Handle

 TS ISO 3315  
 DIN 3122

**1/2"**

 Krom vanadyum, Krom kaplı  
 Chrom vanadium, Chrom plated

KOD CODE	L mm	g	□	TL/Ad.
1513 06 2250	250	355	5	722,50

**13000 005541**
**1000V 1/2" T Kol**  
 1000V Sliding T - Handle

**1/2"**

 Krom vanadyum, Krom kaplı  
 Chrom vanadium, Chrom plated

KOD CODE	L mm	g	□	TL/Ad.
13000 005541	200	660	5	1.549,25

**1513 06 4070**
**1/2" Mafsal**  
 Universal Joint

 TS ISO 3316  
 DIN 3123

**1/2"**

 Krom vanadyum, Krom kaplı  
 Chrom vanadium, Chrom plated

KOD CODE	L mm	g	□	TL/Ad.
1513 06 4070	70	140	5	420,00

**1513**
**1/2" Lokma Adaptörü**  
 Adapter

 TS ISO 3316  
 DIN 3123

**1/2"**

 Krom vanadyum, Krom kaplı  
 Chrom vanadium, Chrom plated

KOD CODE	inch	g	□	TL/Ad.
1513 06 0002	1/2"Fx3/8"M	55	5	156,00
1513 06 0003	1/2"Fx3/4"M	115	5	243,75

**1113 06 5010**
**1/2" Bits Tutucu Lokma**  
 Bit Holder Socket

**1/2"**

 Krom vanadyum, Krom kaplı  
 Chrom vanadium, Chrom plated

KOD CODE	inch	g	□	TL/Ad.
1113 06 5010	1/2" F x 1/4" F	355	5	177,75

Havalı aletler ile kullanmayınız / Do not use with power-tools

**1/4" - 1/2" Altı Köşe Lokma Anahtar Takımı (35 Parça)**  
Socket Wrench Set 6 Point 1/4" - 1/2" (35 Pcs)

1/4"

1/2"

KOD CODE	LOKMALAR Sockets	AVADANLIKLAR Accessories	g		TL/Ad.
1113 00 1038	4 - 5 - 6 7 - 8 - 9 - 10 11 - 12 - 13 Altı Köşe Six Points	1/4" Cırcır kolu Ratchet Handle  1/4" Mafsal Universal Joint  1/4" T Kol Sliding T Handle  1/4" Ara Kol Extension Bar 50 mm  1/4" Ara Kol Extension Bar 100 mm	4000	35	7.071,00
	10 - 11 - 12 13 - 14 - 15 16 - 17 - 18 19 - 21 - 22 24 - 27 - 30 32 Altı Köşe Six Points	1/2" Cırcır Kolu Ratchet Handle  1/2" T Kol Adaptör Sliding T Handle Adapter  1/2" Ara Kol Extension Bar 75 mm  1/2" Ara Kol Extension Bar 250 mm			



**1113 00 2017**

1/2" Altı Köşe Lokma Anahtar Takımı (17 Parça, mm)  
Socket Wrench Set 6 Points (17 pcs, mm)

**1113 00 2024**

1/2" Altı Köşe Lokma Anahtar Takımı (24 Parça, mm)  
Socket Wrench Set 6 Points (24 pcs, mm)



KOD CODE	LOKMALAR Sockets	AVADANLIKLAR Accessories	g	TL/Ad.
1113 00 2017		1/2" Cırcır Kolu Ratchet Handle	2880	17
		1/2" T Kol Adaptör Sliding T Handle Adapter		
	10 - 11 - 12 13 - 14 - 15 17 - 19 - 22 24 - 27 - 30 32	1/2" Mafsal Universal Joint		
		1/2" Ara Kol Extension Bar 250 mm		
				4.953,00

KOD CODE	LOKMALAR Sockets	AVADANLIKLAR Accessories	g	TL/Ad.
1113 00 2024		1/2" Cırcır Kolu Ratchet Handle	3650	24
		1/2" Mafsal Universal Joint		
	10 - 11 - 12 13 - 14 - 15 16 - 17 - 18 19 - 21 - 22 23 - 24 - 26 27 - 28 - 30 32	1/2" T Kol Adaptör Sliding T Handle Adapter		
		1/2" Ara Kol Extension Bar 125 mm		
		1/2" Ara Kol Extension Bar 250 mm		
				6.432,25

**1114 00 6024**

1/2" Oniki Köşe Lokma Anahtar Takımı (24 Parça, mm)  
Socket Wrench Set 12 Points (24 pcs, mm)

**1413 00 6024**

1/2" Oniki Köşe Lokma Anahtar Takımı (24 parça, SAE)  
Socket Wrench Set 12 Points (24 pcs, SAE)



KOD CODE	LOKMALAR Sockets	AVADANLIKLAR Accessories	g	TL/Ad.
1114 00 6024		1/2" Cırcır Kolu Ratchet Handle	4150	24
		1/2" Mafsal Universal Joint		
	10 - 11 - 12 13 - 14 - 15 16 - 17 - 18 19 - 21 - 22 23 - 24 - 26 27 - 28 - 30 32	1/2" T Kol Adaptör Sliding T Handle Adapter		
		1/2" Ara Kol Extension Bar 125 mm		
		1/2" Ara Kol Extension Bar 250 mm		
				6.586,75

KOD CODE	LOKMALAR Sockets	AVADANLIKLAR Accessories	g	TL/Ad.
1413 00 6024		1/2" Cırcır Kolu Ratchet Handle	4150	24
		1/2" Mafsal Universal Joint		
	5/16" - 3/8" 7/16" - 15/32" 1/2" - 9/16" 19/32" - 5/8" 11/16" - 3/4" 25/32" - 13/16" 7/8" - 15/16" 1" - 1 1/16" 1 1/8" - 1 3/16" 1 1/4"	1/2" T Kol Adaptör Sliding T Handle Adapter		
		1/2" Ara Kol Extension Bar 125 mm		
		1/2" Ara Kol Extension Bar 250 mm		
				7.235,75



**Yeni Lokma Setleri**  
*New Socket Wrench Sets*



Ürün Kodu:  
**14000 005131**



Ürün Kodu:  
**14000 005133**



Ürün Kodu:  
**14000 005130**



Ürün Kodu:  
**14000 005132**



Ürün Kodu:  
**14000 005134**



Ürün Kodu:  
**14000 005135**



**1119**
**3/4" Altı Köşe Lokma Anahtar (mm)**  
 Socket Wrench 6 Points (mm)

 TS ISO 2725 -1  
 DIN 3124

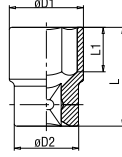
**3/4"**

 Krom vanadyum, Krom kaplı  
 Chrom vanadium, Chrom plated

KOD CODE	mm	σ D1 mm	σ D2 mm	L mm	L1 mm	g	TL/Ad.
1119 06 1022	22	33	36	52	16	225	5 391,25
1119 06 1024	24	35	36	52	16	230	5 391,25
1119 06 1027	27	38	36	52	19	235	5 403,25
1119 06 1030	30	42	38	54	21	300	5 434,50
1119 06 1032	32	44	38	56	23	320	5 452,50
1119 06 1034	34	47	42	58	24	400	5 596,50
1119 06 1036	36	50	42	58	25	440	5 596,50
1119 06 1038	38	52	45	60	27	500	5 596,50
1119 06 1041	41	56	45	64	29	580	1 875,00
1119 06 1046	46	62	48	68	33	730	1 932,50
1119 06 1050	50	68	48	72	34	885	1 1.119,75
1119 06 1055	55	74	48	76	37	1070	1 1.424,50
1119 06 1060	60	80	48	78	38	1170	1 1.701,75

**1120**
**3/4" Oniki Köşe Lokma Anahtar (mm)**  
 Socket Wrench 12 Points (mm)

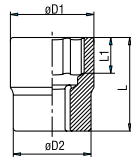
 TS ISO 2725 - 1  
 DIN 3124

**3/4"**

 Krom vanadyum, Krom kaplı  
 Chrom vanadium, Chrom plated

KOD CODE	mm	σ D1 mm	σ D2 mm	L mm	L1 mm	g	TL/Ad.
1120 06 1022	22	33	36	52	16	220	5 413,00
1120 06 1024	24	35	36	52	17	225	5 413,00
1120 06 1027	27	38	36	52	19	225	5 426,00
1120 06 1030	30	42	38	54	21	285	5 458,50
1120 06 1032	32	44	38	56	23	310	5 479,00
1120 06 1034	34	47	42	57	24	385	5 630,00
1120 06 1036	36	50	42	58	25	435	5 630,00
1120 06 1041	41	56	45	64	29	560	1 930,00
1120 06 1046	46	62	47	68	34	685	1 989,00
1120 06 1050	50	68	48	72	34	840	1 1.183,25

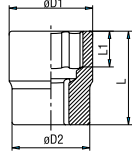
**1419**
**3/4" Oniki Köşe Lokma Anahtar (SAE)**  
 Socket Wrench 12 Points (SAE)

**3/4"**

 Krom vanadyum, Krom kaplı  
 Chrom vanadium, Chrom plated

KOD CODE	inch	σ D1 mm	σ D2 mm	L mm	L1 mm	g	TL/Ad.
1419 06 1022	7/8"	33	36	52	16	220	5 433,25
1419 06 1024	15/16"	35	36	52	16	220	5 433,25
1419 06 1025	1"	35	36	52	17	220	5 434,50
1419 06 1027	1 1/16"	38	36	52	19	225	5 446,50
1419 06 1028	1 1/8"	40	38	52	19	225	5 446,50
1419 06 1032	1 1/4"	44	38	56	23	315	5 500,50
1419 06 1033	1 5/16"	46	38	56	23	355	5 623,00
1419 06 1035	1 3/8"	48	42	58	25	400	5 623,00
1419 06 1036	1 7/16"	50	42	58	25	425	5 651,75
1419 06 1038	1 1/2"	52	45	60	27	475	5 651,75
1419 06 1041	1 5/8"	56	45	64	29	555	1 966,00
1419 06 1044	1 3/4"	60	47	66	31	660	1 1.019,00
1419 06 1046	1 13/16"	62	47	68	34	685	1 1.025,00
1419 06 1047	1 7/8"	64	48	70	34	730	1 1.230,00
1419 06 1050	2"	68	48	72	34	805	1 1.238,50

**1519 06 4510**
**3/4" Cırcır Kolu (45 Diş)**  
 Ratchet Handle (45 Teeth)

 TS ISO 3315  
 DIN 3122

**3/4"**

 Krom vanadyum, Krom kaplı  
 Chrom vanadium, Chrom plated

KOD CODE	L mm	g	TL/Ad.
1519 06 4510	510	2230	5 3.867,75

**1519**
**3/4" Ara Kol**  
 Extension Bar

 TS ISO 1174-1  
 TS ISO 3316  
 DIN 3123

**3/4"**

 Krom vanadyum, Krom kaplı  
 Chrom vanadium, Chrom plated

KOD CODE	L mm	g	TL/Ad.
1519 06 4200	200	730	5 1.021,25
1519 06 4400	400	1370	5 1.848,00



1519 06 4500

**3/4" T Kol**  
Sliding T - Handle

TS ISO 3315  
DIN 3122



**3/4"**

**Krom vanadyum, Krom kaplı**  
Chrom vanadium, Chrom plated

KOD CODE	L mm	g		TL/Ad.
1519 06 4500	500	1485	5	2.055,75

1519

**3/4" Lokma Adaptörü**  
Adapter

TS ISO 3316  
DIN 3123



**3/4"**

**Krom vanadyum, Krom kaplı**  
Chrom vanadium, Chrom plated

KOD CODE	inch	g		TL/Ad.
1519 06 0008	3/4"Fx1/2"M	140	5	408,00
1519 06 0001	3/4"Fx1"M	300	5	551,00

1119 00 6114

**3/4" Altı Köşe Lokma Anahtar Takımı (14 parça, mm)**  
Socket Wrench Set 6 Points (14 pcs, mm)



**3/4"**

KOD CODE	LOKMALAR Sockets	AVADANLIKLAR Accessories	g		TL/Ad.
1119 00 6114	22 - 24 - 27 30 - 32 - 34 36 - 41 - 46 50	3/4" Cırcır Kolu Ratchet Handle	10180	14	14.985,75
		3/4" T Kol Sliding T Handle			
		3/4" Ara Kol Extension Bar 200 mm			
		3/4" Ara Kol Extension Bar 400 mm			

1120 00 6014

**3/4" Oniki Köşe Lokma Anahtar Takımı (14 parça, mm)**  
Socket Wrench Set 12 Points (14 pcs, mm)



**3/4"**

KOD CODE	LOKMALAR Sockets	AVADANLIKLAR Accessories	g		TL/Ad.
1120 00 6014	22 - 24 - 27 30 - 32 - 34 36 - 41 - 46 50	3/4" Cırcır Kolu Ratchet Handle	13700	14	15.344,50
		3/4" T Kol Sliding T Handle			
		3/4" Ara Kol Extension Bar 200 mm			
		3/4" Ara Kol Extension Bar 400 mm			

1419 00 6114

**3/4" Oniki Köşe Lokma Anahtar Takımı (14 parça, SAE)**  
Socket Wrench Set 12 Points (14 pcs, SAE)



**3/4"**

KOD CODE	LOKMALAR Sockets	AVADANLIKLAR Accessories	g		TL/Ad.
1419 00 6114	15/16" - 11/16" 11/8" - 11/4" 15/16" 13/8" 11/2" - 15/8" 17/8" - 2"	3/4" Cırcır Kolu Ratchet Handle	10180	14	15.951,75
		3/4" T Kol Sliding T Handle			
		3/4" Ara Kol Extension Bar 200 mm			
		3/4" Ara Kol Extension Bar 400 mm			

**1225**
**1" Oniki Köşe Lokma Anahtar (mm)**  
 Socket Wrench 12 Points (mm)

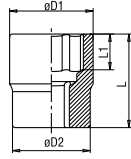
 TS ISO 2725-1  
 DIN 3124

**1"**
**Krom vanadyum, Krom kaplı**  
 Chrom vanadium, Chrom plated

KOD CODE	mm	ø D1 mm	ø D2 mm	L mm	L1 mm	g	TL/Ad.
1225 06 0036	36	52	48	65	26	525	1 1.220,50
1225 06 0041	41	58	50	70	29	665	1 1.328,50
1225 06 0046	46	65	54	75	32	900	1 1.610,50
1225 06 0050	50	70	57	75	34	1040	1 1.907,00
1225 06 0055	55	76	57	83	42	1250	1 2.442,00
1225 06 0060	60	82	60	87	46	1505	1 3.174,00

**1525 06 0005**
**1" Lokma Adaptörü**  
 Adapter

 TS ISO 3316  
 DIN 3123

**1"**
**Krom vanadyum, Krom kaplı**  
 Chrom vanadium, Chrom plated

KOD CODE	inch	g	TL/Ad.
1525 06 0005	1"Fx3/4"M	330	5 785,00

**1800**
**Kovan Anahtar İki Ağız (mm)**  
 Double Ended Tubular Socket Wrench (mm)

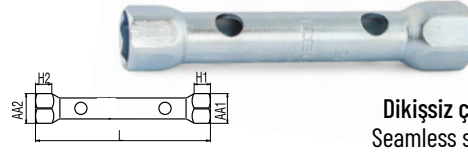
 TS ISO 3793  
 DIN 896

**Dikişsiz çelik boru, Çinko kaplı**  
 Seamless steel tube, Zinc plated

KOD CODE	mm	L mm	AA1 mm	AA2 mm	H1 mm	H2 mm	g	TL/Ad.
1800 07 0607	6x7	105	8.6	9.6	7	8	25	5 182,50
1800 07 0809	8x9	105	11.2	12.2	9	10	35	5 199,25
1800 07 1011	10x11	120	13.6	14.6	11	11.5	55	5 272,50
1800 07 1213	12x13	135	16	17	12	12.5	80	5 289,25
1800 07 1415	14x15	135	18.5	19.5	13	13.5	110	5 318,00
1800 07 1617	16x17	150	21	22	14	14.5	150	5 341,00
1800 07 1819	18x19	150	23	24	15	15.5	170	5 354,00
1800 07 2022	20x22	165	25.4	27.4	16	18	220	5 389,00
1800 07 2224	22x24	180	27.4	29.4	18	20	330	5 437,00
1800 07 2427	24x27	180	30.4	33.4	20	23	400	5 564,00

**1800 00 2108**
**Kovan Anahtar Takımı İki Ağız (mil dahil, mm)**  
 Double Ended Tubular Socket Wrench Set  
 with Tommy Bars (mm)

KOD CODE	mm	g	TL/Ad.
1800 00 2108	6x7 - 8x9 - 10x11 - 12x13 - 14x15 16x17 - 18x19 - 20x22 Mil/Handle Bars 5x125-8x180 mm	920	10 2.528,00

**1841 07 0021**
**Kovan Anahtar Bir Ağız (mil dahil)**  
 Single Ended Tubular Socket Wrench with Tommy Bar

**Dikişsiz çelik boru, Çinko kaplı**  
 Seamless steel tube, Zinc plated

KOD CODE	mm		L mm	øD mm	Mil Handle bar mm	g	TL/Ad.
	mm	inch					
1841 07 0021	21	13/16"	120	20	10x120	215	5 302,50

1850

**Kovan Anahtar Mili**  
Tommy Bar

TS ISO 3793  
DIN 900



KOD CODE	σDxL mm	g	□	TL/Ad.
1850 07 5125	5x125	20	10	72,00
1850 07 8180	8x180	70	10	110,50
1850 07 1120	10x120	75	10	125,00
1850 07 1200	10x200	120	10	140,50

1870

**Ağır Tip Bijon Anahtarı İki Ağız Uzun**  
Double Ended Rim Wrench (long)

TSEK

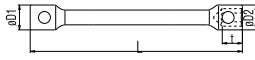

**Yüksek alaşımli çelik, Nikel kaplı**  
Special steel, Nickel plated

KOD CODE	mm	L mm	t mm	σD1 mm	σD2 mm	g	□	TL/Ad.
1870 09 2427	24x27	400	34.5	36	40	1135	10	770,50
1870 09 2730	27x30	400	34.5	40	44	1380	10	884,50
1870 09 2732	27x32	400	34.5	40	46	1380	10	884,50
1870 09 3032	30x32	400	34.5	44	46	1380	10	915,75
1870 09 3233	32x33	400	34.5	46	47	1450	10	1.016,50

1874

**Ağır Tip Bijon Anahtarı İki Ağız Kısa**  
Double Ended Rim Wrench (short)

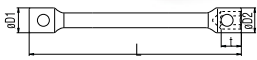

**Yüksek alaşımli çelik, Nikel kaplı**  
Special steel, Nickel plated

KOD CODE	mm	L mm	t mm	σD1 mm	σD2 mm	g	□	TL/Ad.
1874 09 2224	22x24	170	34.5	34	36	720	10	488,50
1874 09 2427	24x27	200	34.5	36	40	800	10	624,00

1850 09 1630

**Bijon Anahtar Mili**  
Tommy Bar

TS ISO 3793  
DIN 900

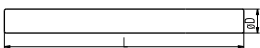

KOD CODE	σDxL mm	g	□	TL/Ad.
1850 09 1630	18x630	1260	1	449,00

1975 09 1719

**Bijon Anahtarı İstavroz Tipi**  
Cross Rim Wrench

TSE  
TS ISO 6788

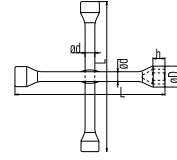

**Yüksek alaşımli çelik, Krom kaplı**  
Special steel, Chrom plated

KOD CODE	mm	inch	σD mm	h mm	L mm	σd mm	g	□	TL/Ad.
	17	11/16"	28	17					
1975 09 1719	19	3/4"	30	18.5	420	16	1422	10	953,00
	21	13/16"	32	19.5					
	22	7/8"	34	20.5					

1975 09 1322

**1/2" Adaptörlü Bijon Anahtarı İstavroz Tipi**  
Cross Rim Wrench (with 1/2" adapter)

TSE  
TS ISO 6788

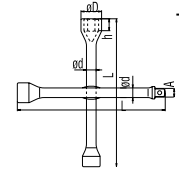

**Yüksek alaşımli çelik, Krom kaplı**  
Special steel, Chrom plated

KOD CODE	mm	inch	σD mm	h mm	L mm	A mm	σd mm	g	□	TL/Ad.
	17	11/16"	28	17						
1975 09 1322	19	3/4"	30	18.5	420	12.65	16	1375	10	957,75
	22	7/8"	34	20.5						
		1/2"								

1940

**Bijon Anahtarı Pipo Tipi (Tornavida Ağızlı)**  
Offset Socket Wrench with Screwdriver

TSEK

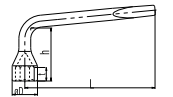

**Yüksek alaşımli çelik, Nikel kaplı**  
Special steel, Nickel plated

KOD CODE	mm	inch	L mm	σD mm	h mm	g	□	TL/Ad.
1940 09 0017	17	11/16"	285	28	65	485	10	479,00
1940 09 0019	19	3/4"	285	30	65	470	10	506,50
1940 09 0021	21	13/16"	320	32	85	575	10	547,25

1840 08 0500

**1/2" Mafsallı T Kol**  
Swivel Handle With Sliding T 1/2"

1/2"



**Özel alaşım çelik, Krom kaplı**  
Special steel, Chrom plated

KOD CODE	mm	L mm	g	□	TL/Ad.
1840 08 0500	1/2"	600	740	10	1.953,75



1610

3/8" Tork Anahtarı  
Torque Wrench

TS EN ISO 6789-1  
TS EN ISO 6789-2



3/8"

KOD CODE	ÖLÇÜ SIZE	L mm	g		TL/Ad.
1610 06 0100	2.5 - 11 Nm - 0.3 - 1.2 Kg	310	515	1	10.809,75
1610 06 0300	7 - 33 Nm - 0.5 - 3.4 Kg	425	640	1	11.177,00

1613

1/2" Tork Anahtarı  
Torque Wrench

TS EN ISO 6789-1  
TS EN ISO 6789-2



1/2"

KOD CODE	ÖLÇÜ SIZE	L mm	g		TL/Ad.
1613 06 1200	25 - 135 Nm - 3 - 14 Kg	550	1430	1	11.541,75
1613 06 2000	50 - 225 Nm - 5 - 23 Kg	600	2165	1	11.912,50
1613 06 3000	70 - 330 Nm - 7 - 35 Kg	830	2870	1	14.496,00

1619 06 2080

3/4" Tork Anahtarı  
Torque Wrench

TS EN ISO 6789-1  
TS EN ISO 6789-2



3/4"



İZELTAS USTA İŞİ  
SOHBETLER

KOD CODE	ÖLÇÜ SIZE	L mm	g		TL/Ad.
1619 06 2080	200 - 800 Nm - 22 - 82 kg	1030	8860	1	44.667,75

1607 06 0420

1/4" Cırcırlı Tork Anahtar  
Torque Wrench With Reversible Ratchet-Head

TS EN ISO 6789-1  
TS EN ISO 6789-2



İZELTAS YOUTUBE

1/4"

KOD CODE	ÖLÇÜ SIZE	L mm	g		TL/Ad.
1607 06 0420	4 - 20 Nm	320	640	1	8.557,25

1610 06 2010

3/8" Cırcırlı Tork Anahtar  
Torque Wrench With Reversible Ratchet-Head

TS EN ISO 6789-1  
TS EN ISO 6789-2



3/8"

KOD CODE	ÖLÇÜ SIZE	L mm	g		TL/Ad.
1610 06 2010	20 - 100 Nm	435	1300	1	9.661,25

1613

1/2" Cırcırlı Tork Anahtar  
Torque Wrench With Reversible Ratchet-Head

TS EN ISO 6789-1  
TS EN ISO 6789-2



1/2"

KOD CODE	ÖLÇÜ SIZE	L mm	g		TL/Ad.
1613 06 4020	40 - 200 Nm	520	1590	1	11.316,00
1613 06 6034	60 - 340 Nm	610	1810	1	11.864,50

1619 06 1060

3/4" Cırcırlı Tork Anahtar  
Torque Wrench With Reversible Ratchet-Head

TS EN ISO 6789-1  
TS EN ISO 6789-2



3/4"

KOD CODE	ÖLÇÜ SIZE	L mm	g		TL/Ad.
1619 06 1060	100 - 600 Nm	1050	5600	1	31.376,50

## 1/2" CIRCIR KOL / RATCHET HANDLE

**Lokmayı salmayan bilya tasarımı  
(kare adaptörlü bilyalı tasarım)**  
Square adaptor with ball design to lock sockets

**Değiştirilebilir iç mekanizma**  
Inter-changeable inner mechanism

**Yüksek dayanım için güçlü 32 diş**  
32 teeth for high endurance

**Çift yönlü kullanım sağlayan mandal tasarımı**  
Bi-directional latch design

**Yüksek mukavemetli alaşımlı sıcak dövme çeliği**  
High strength alloyed cold work tool steel

**Nikel üzerine krom kaplama ile korozyon direncinde üst seviye koruma**  
High corrosion resistance with chrome over nickel plating

**Dayanımı yüksek sert plastikten ve konforlu tutuş sağlayan yumuşak elastomer malzemeden imal edilmiş çift komponentli ergonomik sap**  
Two component ergonomic handle with high strength and soft grip plastic



İZELTAS USTA İŞİ  
SOHBETLER



İZELTAS YOUTUBE

**IZELTAS®**

# HAVALI LOKMA GRUBU

IMPACT SOCKET

- Havalı Lokma Anahtarlar  
Impact Socket Wrenches





### 3/8" Altı Köşe Havalı Lokma Anahtar (mm) Impact Socket Wrench 6 Points (mm)

TS ISO 2725-2

### 3/8" Altı Köşe Havalı Derin Lokma Anahtar (mm) Impact Socket Wrench 6 Points Long Type (mm)

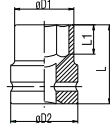

3/8"

Krom molibden, Fosfat kaplamalı  
Chrom molybdenum, Phosphate finish

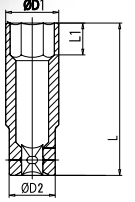

3/8"

Krom molibden, Fosfat kaplamalı  
Chrom molybdenum, Phosphate finish

KOD CODE	Ø mm	Ø D1 mm	Ø D2 mm	L mm	L1 mm	g	TL/ Ad.
14000 004583	6	10.6	19	32	5	33	10 176,50
14000 004584	7	11.8	19	32	5	33	10 176,50
14000 004585	8	13.2	19	32	6	35	10 176,50
14000 004586	9	14.5	19	32	6	35	10 176,50
14000 004587	10	15.5	19	32	7	40	10 176,50
14000 004588	11	17	19	32	7	40	10 176,50
14000 004589	12	18.2	19	32	8	40	10 176,50
14000 004590	13	19.4	22	32	9	55	10 183,75
14000 004591	14	20.7	22	32	9	55	10 183,75
14000 004592	15	22	22	32	10	55	10 209,00
14000 004593	16	23.8	22	32	10	60	10 209,00
14000 004594	17	24.8	22	32	11	60	10 209,00
14000 004595	18	25.8	22	32	11	60	10 209,00
14000 004596	19	27.6	22	32	13	65	10 235,25
14000 004597	20	28.3	22	32	13	70	10 242,50
14000 004598	21	29.5	22	32	13	75	10 248,50
14000 004599	22	30.8	22	32	13	85	10 281,00
14000 004600	23	32	22	32	13	90	10 281,00

KOD CODE	Ø mm	Ø D1 mm	Ø D2 mm	L mm	L1 mm	g	TL/ Ad.
14000 004601	6	10.6	19	65	10	50	10 338,50
14000 004602	7	11.8	19	65	10	55	10 338,50
14000 004603	8	13.2	19	65	12	70	10 338,50
14000 004604	9	14.5	19	65	12	65	10 338,50
14000 004605	10	15.5	19	65	12	80	10 338,50
114000 004606	11	17	19	65	13	75	10 338,50
14000 004607	12	18.2	19	65	14	90	10 338,50
14000 004608	13	19.4	22	65	14	100	10 353,00
14000 004609	14	20.7	22	65	14	110	10 353,00
14000 004610	15	22	22	65	16	110	10 361,25
14000 004611	16	23.8	22	65	16	125	10 361,25
14000 004612	17	24.8	22	65	17	145	10 404,50
14000 004613	18	25.8	22	65	18	135	10 411,75
14000 004614	19	27.6	22	65	20	170	10 411,75
14000 004615	20	28.3	22	65	20	155	10 428,50
14000 004616	21	29.5	22	65	22	160	10 429,75
14000 004617	22	30.8	22	65	22	180	10 429,75
14000 004618	23	32	22	65	24	180	10 451,25



### 3/8" Havalı Lokma Ara Kol Impact Socket Extension Bar

TS ISO 1174-2

**YENİ  
NEW**



**3/8"**

Krom molibden, Fosfat kaplamalı  
Chrom molybdenum, Phosphate finish

KOD CODE	L mm	g	□	TL/Ad.
14000 004619	75	100	10	380,50
14000 004620	125	150	10	504,00

### 14000 004621

### 3/8" Havalı Lokma Adaptör Impact Socket Adapter



**3/8"**

Krom molibden, Fosfat kaplamalı  
Chrom molybdenum, Phosphate finish

KOD CODE	□ inch	g	□	TL/Ad.
14000 004621	3/8"Fx1/2"M	55	10	273,75

### 14000 004622

### 3/8" Havalı Lokma Mafsıl Impact Socket Universal Joint

**YENİ  
NEW**



**3/8"**

Krom molibden, Fosfat kaplamalı  
Chrom molybdenum, Phosphate finish

KOD CODE	□ inch	g	□	TL/Ad.
14000 004622	3/8"	90	10	823,25

### 1113 00 9003

### 1/2" Alaşımli Jant Lokma Takımı (3 Parça, mm) Impact Socket Wrench 6 Points (3 Pcs., mm)



**1/2"**

KOD CODE	LOKMALAR Sockets	g	□	TL/Ad.
1113 00 9003	17-19-21	800	3	2.054,50

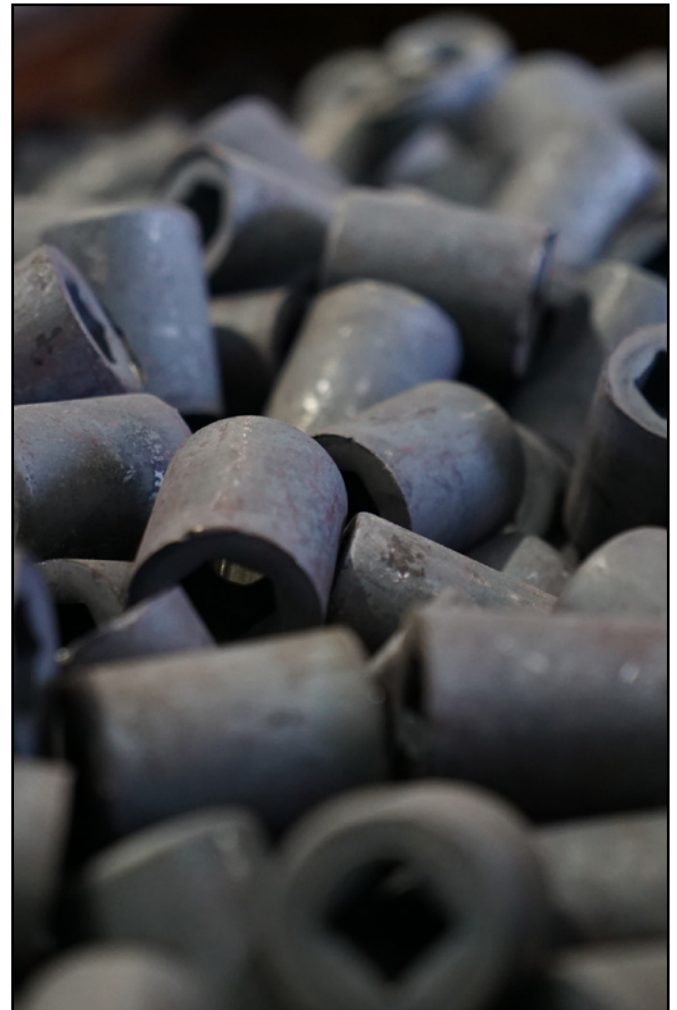

**1/2" Altı Köşe Havalı Lokma Anahtar (mm)**  
 Impact Socket Wrench 6 Points (mm)

TS ISO 2725-2

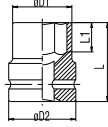

İZELTAS YOUTUBE

**1/2"**

 Krom molibden, Fosfat kaplamalı  
 Chrom molybdenum, Phosphate finish

KOD CODE	mm	σ D1 mm	σ D2 mm	L mm	L1 mm	g	TL/ Ad.
1113 06 7008	8	15	25	38	7	65	10 177,75
1113 06 7009	9	16.5	25	38	7	70	10 177,75
1113 06 7010	10	17.6	25	38	8	70	10 180,00
1113 06 7011	11	18.8	25	38	8	70	10 180,00
1113 06 7012	12	20	25	38	9	75	10 180,00
1113 06 7013	13	21.2	25	38	10	75	10 193,25
1113 06 7014	14	22.5	25	38	10	80	10 193,25
1113 06 7015	15	23.8	30	38	11	115	10 222,00
1113 06 7016	16	25	30	38	11	120	10 231,75
1113 06 7017	17	26.2	30	38	12	120	10 233,00
1113 06 7018	18	27.5	30	38	13	125	10 233,00
1113 06 7019	19	28.8	30	38	13	115	10 237,75
1113 06 7020	20	29.5	30	38	13	115	10 248,50
1113 06 7021	21	30	30	40	14	120	10 251,00
1113 06 7022	22	32.4	30	40	14	130	10 285,75
1113 06 7023	23	33.2	30	40	15	145	10 299,00
1113 06 7024	24	34.4	30	42	15	140	10 296,50
1113 06 7025	25	36	30	42	15	155	10 349,25
1113 06 7026	26	37	30	42	15	175	10 353,00
1113 06 7027	27	37.8	30	44	16	175	10 375,75
1113 06 7028	28	39.8	30	44	16	205	10 403,25
1113 06 7029	29	39.8	30	44	17	200	10 409,25
1113 06 7030	30	41.8	30	44	17	205	10 439,25
1113 06 7032	32	46	30	44	19	240	10 479,00

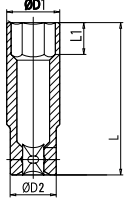
**1/2" Altı Köşe Havalı Derin Lokma Anahtar (mm)** TS ISO 2725-2  
 Impact Socket Wrench 6 Point, Long Type (mm)

**1/2"**

 Krom molibden, Fosfat kaplamalı  
 Chrom molybdenum, Phosphate finish

KOD CODE	mm	σ D1 mm	σ D2 mm	L mm	L1 mm	g	TL/ Ad.
1108 06 7008	8	15	24.8	78	12	125	10 341,00
1108 06 7009	9	16.3	24.8	78	12	135	10 341,00
1108 06 7010	10	17.6	24.8	80	12	150	10 342,00
1108 06 7011	11	18.8	24.8	80	13	155	10 342,00
1108 06 7012	12	20	24.8	80	14	165	10 342,00
1108 06 7013	13	21.2	24.8	80	14	170	10 371,00
1108 06 7014	14	22.5	24.8	80	14	170	10 371,00
1108 06 7015	15	23.8	29.8	80	16	225	10 414,00
1108 06 7016	16	25	29.8	80	16	235	10 414,00
1108 06 7017	17	26.2	29.8	80	16	240	10 414,00
1108 06 7018	18	27.5	29.8	80	17	245	10 414,00
1108 06 7019	19	28.8	29.8	80	18	255	10 414,00
1108 06 7020	20	29	29.8	80	20	245	10 429,75
1108 06 7021	21	29.8	29.8	80	20	245	10 432,00
1108 06 7022	22	32.4	30	80	22	280	10 432,00
1108 06 7023	23	33.2	30	80	24	315	10 452,50
1108 06 7024	24	34.4	30	80	24	295	10 456,00
1108 06 7025	25	36	30	80	24	325	10 535,25
1108 06 7026	26	37	30	80	27	365	10 541,25
1108 06 7027	27	37.8	30	80	27	365	10 602,50
1108 06 7028	28	39.8	30	80	27	425	10 606,00
1108 06 7029	29	39.8	30	80	27	405	10 606,00
1108 06 7030	30	41.8	30	80	30	420	10 675,75
1108 06 7032	32	46	30	80	32	505	10 720,00

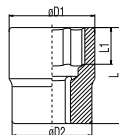
**1/2" Havalı Star (Torx®) Lokma Anahtar**  
 Impact Socket Star (Torx®) Wrench

 Krom molibden, Fosfat kaplamalı  
 Chrom molybdenum, Phosphate finish

**1/2"**

KOD CODE	mm	σ D1 mm	σ D2 mm	L mm	L1 mm	g	TL/ Ad.
14000 004539	E10	14	25	38	7.5	70	10 353,00
14000 005160	E12	15.9	25	38	9	70	10 353,00
14000 004540	E14	17.7	25	38	10	70	10 353,00
14000 004541	E16	20	25	38	11	75	10 353,00
14000 004542	E18	22	25	38	12.5	80	10 395,00
14000 004543	E20	24.5	30	38	14	120	10 422,50
14000 004544	E22	26	30	38	15	120	10 459,75
14000 004545	E24	28	30	38	16	120	10 479,00



## 1/2" Havalı Allen Uç Lokma Anahtar Impact Socket Hexagonal Bits Socket Wrench



1/2"

Krom molibden, Fosfat kaplamalı  
Chrom molybdenum, Phosphate finish

KOD CODE	mm	L mm	g		TL/Ad.
14000 004546	H4	80	70	10	451,25
14000 004547	H5	80	75	10	451,25
14000 004548	H6	80	75	10	451,25
14000 004549	H8	80	85	10	493,25
14000 004550	H10	80	100	10	493,25
14000 004551	H12	80	120	10	493,25
14000 004552	H14	80	140	10	493,25
14000 004553	H17	80	220	10	522,00
14000 004554	H19	80	245	10	620,50

## 1/2" Havalı Star (Torx®) Uç Lokma Anahtar Impact Socket Star (Torx®) Bits Socket Wrench



1/2"

Krom molibden, Fosfat kaplamalı  
Chrom molybdenum, Phosphate finish

KOD CODE		L mm	g		TL/Ad.
14000 004573	T20	100	70	10	522,00
14000 004574	T25	100	70	10	522,00
14000 004575	T27	100	75	10	522,00
14000 004576	T30	100	75	10	522,00
14000 004577	T40	100	80	10	522,00
14000 004578	T45	100	90	10	535,25
14000 004579	T50	100	100	10	549,75
14000 004580	T55	100	120	10	549,75
14000 004581	T60	100	140	10	549,75
14000 004582	T80	100	180	10	620,50

1513 06 7125

## 1/2" Havalı Lokma Ara Kol Impact Socket Extension Bar

TS ISO 1174-2



1/2"

Krom molibden, Fosfat kaplamalı  
Chrom molybdenum, Phosphate finish

KOD CODE	L mm	g		TL/Ad.
1513 06 7125	125	275	5	680,50

1513

## 1/2" Havalı Lokma Adaptörü Impact Socket Adapter



1/2"

Krom molibden, Fosfat kaplamalı  
Chrom molybdenum, Phosphate finish

KOD CODE	inch	g		TL/Ad.
1513 06 7002	1/2"Fx3/8"M	95	5	450,00
1513 06 7003	1/2"Fx3/4"M	175	5	513,75

1513 06 7075

## 1/2" Havalı Lokma Mafsalsal Impact Socket Universal Joint



1/2"

Krom molibden, Fosfat kaplamalı  
Chrom molybdenum, Phosphate finish

KOD CODE	L mm	g		TL/Ad.
1513 06 7075	75	220	5	864,00

**3/4" Altı Köşe Havalı Lokma Anahtar (mm)**  
**Impact Socket Wrench 6 Points (mm)**

TS ISO 2725-2

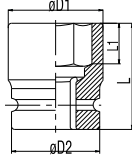
**3/4"**
**Krom molibden, Fosfat kaplamalı**  
**Chrom molybdenum, Phosphate finish**

KOD CODE	Ø mm	σ D1 mm	σ D2 mm	L mm	L1 mm	g	TL/Ad.
1119 06 7017	17	29	44	50	10	310	5 677,00
1119 06 7018	18	30	44	50	10	315	5 677,00
1119 06 7019	19	32	44	50	10	325	5 677,00
1119 06 7020	20	33	44	50	10	335	5 677,00
1119 06 7021	21	35	44	50	13	335	5 677,00
1119 06 7022	22	36	44	50	13	340	5 677,00
1119 06 7023	23	37	44	50	15	340	5 677,00
1119 06 7024	24	38	44	50	15	345	5 677,00
1119 06 7025	25	41	44	53	15	365	5 677,00
1119 06 7026	26	40	44	53	15	365	5 677,00
1119 06 7027	27	42	44	53	18	380	5 677,00
1119 06 7028	28	44	44	53	18	390	5 677,00
1119 06 7029	29	45	44	53	18	400	5 677,00
1119 06 7030	30	46	44	53	20	350	1 677,00
1119 06 7032	32	48	44	57	20	455	1 677,00
1119 06 7033	33	50	44	57	20	480	1 761,00
1119 06 7034	34	51	44	57	22	490	1 870,00
1119 06 7035	35	53	44	57	22	500	1 775,25
1119 06 7036	36	53	44	57	22	510	1 870,00
1119 06 7038	38	56	44	57	22	555	1 845,00
1119 06 7041	41	59	44	58	24	585	1 1.343,00
1119 06 7044	44	64	44	62	24	706	1 1.421,00
1119 06 7046	46	66	44	62	24	730	1 1.427,00
1119 06 7050	50	71	44	65	26	870	1 1.633,25
1119 06 7055	55	77	54	70	30	1200	1 1.859,00
1119 06 7060	60	84	54	70	32	1425	1 2.281,25

**3/4" Altı Köşe Havalı Derin Lokma Anahtar (mm)**  
**Impact Socket Wrench 6 Points, Long Type (mm)**

TS ISO 2725-2

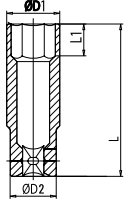
**3/4"**
**Krom molibden, Fosfat kaplamalı**  
**Chrom molybdenum, Phosphate finish**

KOD CODE	Ø mm	σ D1 mm	σ D2 mm	L mm	L1 mm	g	TL/Ad.
14000 004504	17	29	44	90	15	480	5 1.028,50
14000 004505	18	30	44	90	15	500	5 1.028,50
14000 004506	19	32	44	90	16	545	5 1.028,50
14000 004507	20	32	44	90	17	545	5 1.028,50
14000 004508	21	35	44	90	18	565	5 1.028,50
14000 004509	22	36	44	90	18	580	5 1.028,50
14000 004510	23	37	44	90	23	600	5 1.028,50
14000 004511	24	38	44	90	23	600	5 1.028,50
14000 004512	25	40	44	90	25	630	5 1.028,50
14000 004513	26	40	44	90	25	600	5 1.028,50
14000 004514	27	42	44	90	27	625	5 1.028,50
14000 004515	28	44	44	90	27	665	5 1.056,00
14000 004516	29	45	44	90	27	665	5 1.070,50
14000 004517	30	46	44	90	27	695	1 1.070,50
14000 004518	32	48	44	90	30	730	1 1.070,50
14000 004519	33	50	44	90	30	790	1 1.154,50
14000 004520	34	51	44	90	32	795	1 1.197,75
14000 004521	35	52	44	90	32	810	1 1.296,00
14000 004522	36	53	44	90	32	820	1 1.296,00
14000 004523	38	56	44	90	34	880	1 1.436,50
14000 004524	41	59	44	90	34	935	1 1.718,50
14000 004525	46	66	44	95	38	1240	1 1.886,50
14000 004526	50	71	44	95	40	1315	1 2.352,00
14000 004527	55	77	54	100	45	1800	1 2.813,00

**3/4" Havalı Allen Uç Lokma Anahtar (mm)**  
**Impact Socket Hexagonal Bits Socket Wrench (mm)**

**Krom molibden, Fosfat kaplamalı**  
**Chrom molybdenum, Phosphate finish**

**3/4"**

KOD CODE	Ø mm	L mm	g	TL/Ad.
14000 004528	H14	87	310	5 1.647,75
14000 004529	H17	87	340	5 1.647,75
14000 004530	H19	87	365	5 1.647,75
14000 004531	H21	87	510	5 1.647,75
14000 004532	H22	87	525	5 1.647,75
14000 004533	H24	87	545	5 1.775,00
14000 004534	H27	87	600	5 1.775,00
14000 004535	H30	87	710	1 1.775,00
14000 004536	H32	87	750	1 1.957,25
14000 004537	H36	87	830	1 2.028,00

1519

**3/4" Havalı Lokma Ara Kol**  
Impact Socket Extension Bar

TS ISO 1174-2



1519 06 7108

**3/4" Havalı Lokma Mafsal**  
Impact Socket Universal Joint



3/4"

Krom molibden, Fosfat kaplamalı  
Chrom molybdenum, Phosphate finish

KOD CODE	L mm	g	TL/ Ad.
1519 06 7175	175	865	5 1.483,25
1519 06 7250	250	1155	5 2.120,50
1519 06 7330	330	1425	5 3.217,25

3/4"

Krom molibden, Fosfat kaplamalı  
Chrom molybdenum, Phosphate finish

KOD CODE	L mm	g	TL/ Ad.
1519 06 7108	108	735	5 2.469,75

1519

**3/4" Havalı Lokma Adaptörü**  
Impact Socket Adapter



3/4"

Krom molibden, Fosfat kaplamalı  
Chrom molybdenum, Phosphate finish

KOD CODE	inch	g	TL/ Ad.
1519 06 7011	3/4"Fx1/2"M	315	5 857,00
1519 06 7012	3/4"Fx1"M	445	5 1.112,50





**1" Altı Köşe Havalı Lokma Anahtar (mm)**  
**Impact Socket Wrench 6 Points (mm)**

TS ISO 2725-2

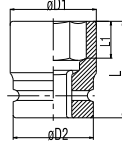
**1"**
**Krom molibden, Fosfat kaplamalı**  
**Chrom molybdenum, Phosphate finish**

KOD CODE	Ø mm	σ D1 mm	σ D2 mm	L mm	L1 mm	g	TL/Ad.
1125 06 7021	21	37	54	58	15	540	1 999,75
1125 06 7022	22	38	54	58	15	550	1 999,75
1125 06 7023	23	39	54	58	17	545	1 999,75
1125 06 7024	24	41	54	58	17	560	1 999,75
1125 06 7025	25	42	54	58	17	560	1 999,75
1125 06 7026	26	43	54	58	19	565	1 999,75
1125 06 7027	27	44	54	58	19	565	1 999,75
1125 06 7028	28	45	54	58	19	570	1 999,75
1125 06 7029	29	47	54	58	19	590	1 999,75
1125 06 7030	30	48	54	60	20	590	1 1.103,00
1125 06 7032	32	51	54	62	20	645	1 1.116,00
1125 06 7033	33	52	54	62	20	660	1 1.116,00
1125 06 7034	34	53	54	62	20	665	1 1.122,00
1125 06 7035	35	54	54	62	20	665	1 1.124,50
1125 06 7036	36	56	54	65	20	720	1 1.127,00
1125 06 7038	38	58	54	65	22	735	1 1.173,75
1125 06 7041	41	61	54	70	22	825	1 1.430,50
1125 06 7046	46	68	54	75	26	1035	1 1.577,00
1125 06 7048	48	70	54	75	26	1060	1 1.682,50
1125 06 7050	50	73	54	75	26	1170	1 1.682,50
1125 06 7055	55	79	54	83	32	1435	1 2.229,75
1125 06 7060	60	86	54	87	32	1695	1 2.787,75
1125 06 7065	65	92	54	90	34	1750	1 3.097,25
1125 06 7070	70	97	54	93	34	2035	1 4.082,50
1125 06 7075	75	104	86	95	36	3120	1 5.490,00
1125 06 7080	80	110	86	95	43	3390	1 6.335,00
1125 06 7085	85	115	86	95	43	3530	1 8.447,00
1125 06 7090	90	122	86	100	43	4005	1 10.277,00

**1" Altı Köşe Havalı Derin Lokma Anahtar (mm)**  
**Impact Socket Wrench 6 Points, Long Type (mm)**

TS ISO 2725-2

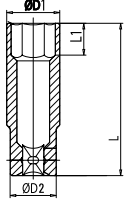
**YENİ  
NEW**

**1"**
**Krom molibden, Fosfat kaplamalı**  
**Chrom molybdenum, Phosphate finish**

KOD CODE	Ø mm	σ D1 mm	σ D2 mm	L mm	L1 mm	g	TL/Ad.
14000 004462	21	38	54	90	25	810	1 1.380,00
14000 004463	22	39	54	90	25	840	1 1.380,00
14000 004464	23	40	54	90	25	850	1 1.380,00
14000 004465	24	41	54	90	25	875	1 1.380,00
14000 004466	25	42	54	90	25	890	1 1.380,00
14000 004467	26	43	54	90	25	910	1 1.380,00
14000 004468	27	44	54	90	25	870	1 1.380,00
14000 004469	28	45	54	90	25	890	1 1.409,00
14000 004470	29	47	54	90	15	900	1 1.409,00
14000 004471	30	48	54	90	28	910	1 1.409,00
14000 004472	32	51	54	90	28	955	1 1.518,00
14000 004473	33	51	54	92	28	1015	1 1.518,00
14000 004474	34	53	54	92	28	990	1 1.577,00
14000 004475	35	54	54	92	28	1020	1 1.675,25
14000 004476	36	56	54	92	32	1035	1 1.675,25
14000 004477	38	58	54	92	32	1050	1 1.915,25
14000 004478	41	61	54	92	32	1095	1 2.055,75
14000 004479	46	68	54	95	35	1330	1 2.365,25
14000 004480	50	73	54	95	35	1380	1 2.816,50
14000 004481	55	70	54	100	40	1705	1 3.660,00
14000 004482	60	86	54	100	42	2020	1 4.787,00
14000 004483	65	92	54	110	50	2135	1 6.222,00
14000 004484	70	97	54	110	59	2285	1 7.911,75
14000 004485	75	104	86	120	60	3400	1 9.348,00
14000 004486	80	110	86	120	60	4200	1 10.727,00
14000 004487	85	115	86	120	60	3980	1 17.597,00
14000 004488	90	122	86	125	65	5000	1 20.412,00



1525

1" Havalı Lokma Ara Kol  
Impact Socket Extension Bar

TS ISO 1174-2



1"

Krom molibden, Fosfat kaplamalı  
Chrom molybdenum, Phosphate finish

KOD CODE	L mm	g		TL/Ad.
1525 06 7175	175	1395	5	2.705,00
1525 06 7250	250	1890	5	3.475,25
1525 06 7330	330	2455	5	4.224,00

1525 06 7128

1" Havalı Lokma Mafsal  
Impact Socket Universal Joint



1"

Krom molibden, Fosfat kaplamalı  
Chrom molybdenum, Phosphate finish

KOD CODE	L mm	g		TL/Ad.
1525 06 7128	128	1530	1	5.042,50

1525 06 7015

1" Havalı Lokma Adaptörü  
Impact Socket Adapter



1"

Krom molibden, Fosfat kaplamalı  
Chrom molybdenum, Phosphate finish

KOD CODE	inch	g		TL/Ad.
1525 06 7015	1"Fx3/4"M	560	5	1.035,75









# BORU ANAHTARLARI VE PENSELER

PIPE WRENCHES AND PLIERS

- Boru Anahtarları  
Pipe Wrenches
- Fort Penseler  
Water Pump Pliers
- Ayarlı Penseler  
Grip Wrenches
- Penseler  
Pliers
- Kargaburunlar  
Nose Pliers
- Yan Keskiler  
Side Cutters
- Segman Penseler  
Circlip Pliers
- Özel Amaçlı Penseler  
Special Pliers
- Elektronikçi Penseler  
Electronic Pliers
- Kerpetenler  
Carpenter Pincers



**Güçlü kavrama sağlayan  
tırnaklı tutma yüzeyleri**  
Toothed surface for strong grip

**Isıl işlem sonrasında indüksiyonda  
sertleştirme ile kullanım ömrü  
artırılmış kesici ağızlar**  
Heat-treated and induction hardened  
cutting edges for long lifetime

**Siyah fosfat kaplama ile  
korozyon direnci**  
High corrosion resistance  
with manganese phosphate coating

**Yüksek karbonlu  
sıcak dövme çeliği  
ile arttırılmış  
dayanım**  
High carbon forged  
steel for improved  
durability

**Düşmelere ve darbeye dayanıklı,  
P.P. ergonomik sap**  
Impact resistant P.P. handle



2100

**Stilson Boru Anahtarı**  
Pipe Wrench, Stilson



TS 3796



Yedek parça sayfa 255-259  
Spare parts page 255-259

**Krom vanadyum, Dişler indüksiyonda sertleştirilmiş, Elektrostatik boyanmış**  
Chrom vanadium, Teeth induction hardened, Electrostatically painted

KOD CODE	L mm	L inch	mm	ÖLÇÜ SIZE mm	g	TL/Ad.
2100 10 0008	200	8"	27	6-20	280	1 1.207,25
2100 10 0010	250	10"	34	6-26	550	1 1.452,00
2100 10 0012	300	12"	42	10-32	725	1 1.633,25
2100 10 0014	350	14"	50	13-38	1030	1 2.005,25
2100 10 0018	450	18"	60	26-52	1775	1 2.545,25
2100 10 0024	600	24"	76	38-65	2775	1 4.098,00

2201

**Maşalı Boru Anahtarı (85°)**  
Pipe Wrench (85°)



TS 3796  
DIN 5234



Yedek parça sayfa 255-259  
Spare parts page 255-259

**Krom vanadyum, Dişler indüksiyonda sertleştirilmiş, Elektrostatik boyanmış**  
Chrom vanadium, Teeth induction hardened, Electrostatically painted

KOD CODE	L mm	mm	ÖLÇÜ SIZE Inch	g	TL/Ad.
2201 10 0010	325	40	1"	870	1 1.229,00
2201 10 0015	430	60	1 1/2"	1585	1 1.903,25
2201 10 0020	585	70	2"	2700	1 2.849,00
2201 10 0030	690	100	3"	4270	1 4.317,75
2201 10 0040	760	130	4"	5800	1 6.475,25

2110

**Ağır Tip Boru Anahtarı**  
Pipe Wrench, Heavy Duty



Yedek parça sayfa 255-259  
Spare parts page 255-259

**Krom vanadyum, Dişler indüksiyonda sertleştirilmiş, Elektrostatik boyanmış**  
Chrom vanadium, Teeth induction hardened, Electrostatically painted

KOD CODE	L mm	L inch	mm	ÖLÇÜ SIZE Inch	g	TL/Ad.
2110 10 0008	200	8"	34	1"	425	1 1.603,25
2110 10 0010	250	10"	42	1 1/4"	795	1 1.989,75
2110 10 0012	300	12"	50	1 1/2"	1245	1 2.277,75
2110 10 0014	350	14"	60	2"	1710	1 2.652,00
2110 10 0018	450	18"	75	2 1/2"	2685	1 3.699,75
2110 10 0024	600	24"	90	3"	4370	1 5.965,25
2110 10 0036	900	36"	140	5"	7600	1 13.211,00
2110 10 0048	1200	48"	165	6"	15600	1 27.055,25

**Zincirli Boru Anahtarı**  
Chain Pipe Wrench

**YENİ NEW**

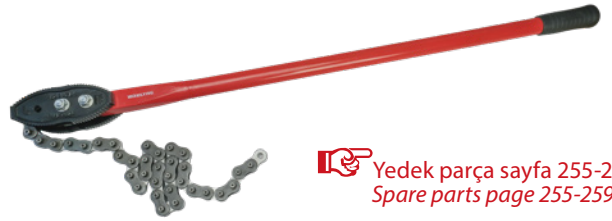

Yedek parça sayfa 255-259  
Spare parts page 255-259

**Dişler indüksiyonda sertleştirilmiş, Elektrostatik boyanmış**  
Teeth induction hardened, Electrostatically painted

KOD CODE	L mm	mm	ÖLÇÜ SIZE Inch	g	TL/Ad.
14000 005036	940	115	4"	4770	1 9.854,50
14000 005037	1125	165	6"	8580	1 13.374,00
14000 005140	1280	220	8"	12820	1 22.524,00

**Zincirli Boru Anahtarı Yedek Zinciri**  
Spare Chain For Chain Pipe Wrench

**YENİ NEW**



KOD CODE	ÖLÇÜ SIZE Inch	L mm	g	TL/Ad.
14000 005039	4"	555	840	1 2.421,75
14000 005038	6"	785	1635	1 4.224,00
14000 005139	8"	990	2400	1 4.927,25



2400

**Üniversal Fort Pense**  
Waterpump Pliers Universal



TS 60 TS ISO 8976  
DIN ISO 8976



IZELTAS YOUTUBE

**Krom vanadyum, Krom kaplı, PVC izoleli**  
Chrom vanadium, Chrom plated, PVC insulated

KOD CODE	L mm	L inch	mm	g	TL/ Ad.
2400 11 0160	160	6 1/4"	30	125	5 753,75
2400 11 0240	240	9 1/2"	35	355	5 1.052,50
2400 11 0315	315	12 1/2"	40	530	5 1.723,25

2400 11 6240

**1000V İzoleli Üniversal Fort Pense**  
Insulated Type Waterpump  
Pliers Universal 1000V

TS 60  
TS ISO 8976  
1000 V  
IEC 60900



**Krom vanadyum, Krom kaplı, Çift komponent saplı**  
Chrom vanadium, Chrom plated, Two component handle

KOD CODE	L mm	L inch	mm	g	TL/ Ad.
2400 11 6240	240	9 1/2"	35	370	5 1.221,75

2415 11 0240

**Yaylı Fort Pense**  
Waterpump Pliers With Spring

**YENİ TASARIM**  
NEW DESIGN



IZELTAS USTA İŞİ  
SOHBETLER

**Karartma, PVC izoleli**  
Black finish, PVC insulated

KOD CODE	L mm	L inch	mm	g	TL/ Ad.
2415 11 0240	240	9 1/2"	43	300	5 1.419,75



2500 11 0250

**Üniversal Ayarlı Pense**  
Universal Grip



Çeneler krom vanadyum çeliğinden dövülmüştür, Nikel kaplama,  
Kullanım sahası: Yuvarlak ve düz malzemeler  
Jaws Chrom vanadium forged, Nickel plated  
Application field : Flat and round materials

KOD CODE	L mm	L inch	mm	g	TL/ Ad.
2500 11 0250	250	10"	30	560	5 1.254,00

2510 11 0250

**Spesiyal Ayarlı Pense**  
Special Grip



Çeneler krom vanadyum çeliğinden dövülmüştür, Nikel kaplama,  
Kullanım sahası: Yuvarlak ve düz malzemeler  
Jaws Chrom vanadium forged, Nickel plated  
Application field: Flat and round materials

KOD CODE	L mm	L inch	mm	g	TL/ Ad.
2510 11 0250	250	10"	30	550	5 1.254,00

2505 11 0250

**Standart Ayarlı Pense**  
Standard Grip



Çeneler krom vanadyum çeliğinden dövülmüştür, Nikel kaplama  
Kullanım sahası: Düz malzemeler  
Jaws, Chrom vanadium forged, Nickel plated  
Application field: Flat materials

KOD CODE	L mm	L inch	mm	g	TL/ Ad.
2505 11 0250	250	10"	30	535	5 1.254,00

2511 11 0280

**C Tipi Ayarlı Pense**  
Clamp Grip C-type



Çeneler krom vanadyum çeliğinden dövülmüştür, Nikel kaplama,  
Kullanım sahası: Açılı profillerin tutulmasında  
Jaws Chrom vanadium forged, Nickel plated  
Application field: For Gripping angled sheet metal

KOD CODE	L mm	L inch	mm	g	TL/ Ad.
2511 11 0280	280	11"	70	700	1 2.095,25

**2512 11 0200****Kaynakçı Ayarlı Pense (Düz Ağız)**  
Lock Grip With Flat Jaws

Özel alaşımli çelikten imal edilmiş, Nikel kaplama,  
Kullanım sahası: 80 mm düz çeneleri ile kıvrık metal levhaları  
Made from special alloy steel, Nickel plated,  
Application field: Gripping sheet metals with 80 mm Flat jaws

KOD CODE	L mm	L inch	mm	g	TL/Ad.
2512 11 0200	200	8"	30	485	1 2.114,50

**2515 11 0270****Kaportacı Ayarlı Pense**  
Welding Grip

Özel alaşımli çelikten imal edilmiş- Nikel kaplama,  
Kullanım sahası: Yassı ve köşeli malzemelerde  
Made from special alloy steel, Nickel plated  
Application field : Angled corners and edges

KOD CODE	L mm	L inch	mm	g	TL/Ad.
2515 11 0270	270	10 5/8"	50	765	1 1.679,00

**2513 11 0280****Kaynakçı Ayarlı Pense (Boru İçin)**  
Grip For Tubes

Özel alaşımli çelikten imal edilmiş, Nikel kaplama,  
Kullanım sahası: Boru malzemeler  
Made from special alloy steel, Nickel plated,  
Application field: Tubes

KOD CODE	L mm	L inch	mm	g	TL/Ad.
2513 11 0280	280	11"	50	800	1 2.114,50

**3020****Kombine Pense Opak Seri**  
Combination Pliers

TS 60  
TS ISO 5746  
DIN ISO 5746



IZELTAS YOUTUBE

Özel alaşımli çelik, Kesici ağızlar indüksiyonda sertleştirilmiş  
Special steel, Cutters induction hardened

KOD CODE	L mm	L inch	g	TL/Ad.
3020 12 2160	160	6 1/4"	205	5 655,25
3020 12 2180	180	7 1/8"	275	5 743,00
3020 12 2200	200	8"	315	5 837,75



**3020**
**Kombine Pense Kraft Seri**  
 Combination Pliers

 TS 60  
 TS ISO 5746  
 DIN ISO 5746

 Özel alaşımlı çelik, Kesici ağızlar indüksiyonda sertleştirilmiş  
 Special steel, Cutters induction hardened

KOD CODE	L mm	L inch	g	□	TL/Ad.
3020 12 3160	160	6 1/4"	225	5	801,75
3020 12 3180	180	7 1/8"	285	5	896,50
3020 12 3200	200	8"	380	5	1.013,00

**3020**
**1000V İzoleli Elektrikçi Kombine Pense**  
 Electrician Type Insulated  
 Combination Pliers 1000V

 TS 60  
 TS ISO 5746  
 DIN ISO 5746  
 ⚡ 1000 V  
 IEC 60900

 Özel alaşımlı çelik, Kesici ağızlar indüksiyonda sertleştirilmiş, Krom kaplı  
 Special steel, Cutters induction hardened, Chrom plated

KOD CODE	L mm	L inch	g	□	TL/Ad.
3020 12 6160	160	6 1/4"	205	5	900,00
3020 12 6180	180	7 1/8"	260	5	965,00
3020 12 6200	200	8"	345	5	1.088,50

**13000 005118**
**Kombine Pense Black Line**  
 Combination Pliers

 TS 60  
 TS ISO 5746  
 DIN ISO 5746

 Özel alaşımlı çelik, Mangan fosfat kaplı,  
 Kesici ağızlar indüksiyonda sertleştirilmiş  
 Special steel, Phosphate finish, Cutters induction hardened

KOD CODE	L mm	L inch	g	□	TL/Ad.
13000 005118	180	7 1/8"	275	5	1.085,00

**3030**
**Kombine Pense Ağır Tip (çelik tel için)**  
 Combination Pliers Heavy Duty  
 (for piano wire)

 Özel alaşımlı çelik, Kesici ağızlar indüksiyonda sertleştirilmiş,  
 Special steel, Cutters induction hardened

KOD CODE	L mm	L inch	g	□	TL/Ad.
3030 12 2180	180	7 1/8"	285	5	1.118,50
3030 12 2200	200	8"	380	5	1.279,25

3220

Kargaburun Düz Uçlu Opak Seri  
Long Nose Pliers (Flat)



TS 60 - TS ISO 5745  
DIN ISO 5745



İZELTAS YOUTUBE

Özel alaşımli çelik, Kesici ağızlar indüksiyonda sertleştirilmiş  
Special steel, Cutters induction hardened

KOD CODE	L mm	L inch	g	TL/Ad.
3220 13 2140	140	5 1/2"	110	644,50
3220 13 2160	160	6 1/4"	135	729,75
3220 13 2180	180	7 1/8"	170	801,75
3220 13 2200	200	8"	205	849,75

3220

Kargaburun Düz Uçlu Kraft Seri  
Long Nose Pliers (Flat)



TS 60 - TS ISO 5745  
DIN ISO 5745



Özel alaşımli çelik, Kesici ağızlar indüksiyonda sertleştirilmiş  
Special steel, Cutters induction hardened

KOD CODE	L mm	L inch	g	TL/Ad.
3220 13 3140	140	5 1/2"	120	795,75
3220 13 3160	160	6 1/4"	155	897,75
3220 13 3180	180	7 1/8"	185	987,75
3220 13 3200	200	8"	210	1.047,75

3220

1000V İzoleli Elektrikçi Kargaburun Düz Uçlu  
Insulated Electrician Type  
Long Nose Pliers 1000V



TS 60  
TS ISO 5745  
DIN ISO 5745  
△ 1000 V  
IEC 60900



Özel alaşımli çelik, Kesici ağızlar indüksiyonda sertleştirilmiş, Krom kaplı  
Special steel, Cutters induction hardened, Chrom plated

KOD CODE	L mm	L inch	g	TL/Ad.
3220 13 6140	140	5 1/2"	110	921,75
3220 13 6160	160	6 1/4"	140	1.019,00
3220 13 6180	180	7 1/8"	160	1.143,75
3220 13 6200	200	8"	170	1.188,00

13000 005117

Düz Kargaburun Black Line  
Long Nose Pliers (Flat)



TS 60 - TS ISO 5745  
DIN ISO 5745



Özel alaşımli çelik, Mangano fosfat kaplı,  
Kesici ağızlar indüksiyonda sertleştirilmiş  
Special steel, Phosphate finish, Cutters induction hardened

KOD CODE	L mm	L inch	g	TL/Ad.
13000 005117	180	7 1/8"	170	1.287,75

**3225**
**Kargaburun Eğri Uçlu Opak Seri**  
 Long Nose Pliers (Bent)

  
 TS 60 - TS ISO 5745

 Özel alaşımlı çelik, Kesici ağızlar indüksiyonda sertleştirilmiş  
 Special steel, Cutters induction hardened

KOD CODE	L mm	L inch	g	□	TL/Ad.
3225 13 2160	160	6 1/4"	140	5	770,50
3225 13 2180	180	7 1/8"	170	5	870,00
3225 13 2200	200	8"	175	5	929,00

**3225**
**Kargaburun Eğri Uçlu Kraft Seri**  
 Long Nose Pliers (Bent)

  
 TS 60 - TS ISO 5745

 Özel alaşımlı çelik, Kesici ağızlar indüksiyonda sertleştirilmiş  
 Special steel, Cutters induction hardened

KOD CODE	L mm	L inch	g	□	TL/Ad.
3225 13 3160	160	6 1/4"	150	5	926,50
3225 13 3180	180	7 1/8"	190	5	1.016,50
3225 13 3200	200	8"	195	5	1.118,50

**3020 00 2003**
**Opak Pense Seti 160mm (3 Parça)**  
 Opak Pliers Set 160mm (3 Pcs)

KOD CODE	L mm	İÇERİK CONTENTS	□	TL/Ad.
3020 12 2160	160	Kombine Pense Opak Seri Combination Pliers 160mm	1	2.206,00
3220 13 2160	160	Kargaburun Düz Uçlu Opak Seri Long Nose Pliers (Flat) 160mm	1	
3700 16 2160	160	Yan Keski Opak Seri Side Cutting Pliers 160mm	1	

**3020 00 1002**
**Pense Kontrol Kalem Seti (2 Parça)**  
 Opak Pliers Set, Voltage Tester (Flat) 2 Pcs

**Anahtarlık Hediye!**  
 Gift Key Chain

KOD CODE	L mm	İÇERİK CONTENTS	□	TL/Ad.
3020 12 2160	160	Kombine Pense Opak Seri Combination Pliers 160mm	1	831,75
4550 17 0190	190	Elektrik Kontrol Kalem (Düz Uçlu) Voltage Tester (Flat) 190mm	1	



3700

**Yan Keski Opak Seri**  
Side Cutting Pliers



TS 60 - TS ISO 5749  
DIN ISO 5749



IZELTAS YOUTUBE

Özel alaşımli çelik, Kesici ağızlar indüksiyonda sertleştirilmiş  
Special steel, Cutters induction hardened

KOD CODE	L mm	L inch	g	TL/Ad.
3700 16 2140	140	5 1/2"	165	681,75
3700 16 2160	160	6 1/4"	230	821,00
3700 16 2180	180	7 1/8"	240	956,50

3700

**Yan Keski Kraft Seri**  
Side Cutting Pliers



TS 60 - TS ISO 5749  
DIN ISO 5749



Özel alaşımli çelik, Kesici ağızlar indüksiyonda sertleştirilmiş  
Special steel, Cutters induction hardened

KOD CODE	L mm	L inch	g	TL/Ad.
3700 16 3140	140	5 1/2"	190	822,00
3700 16 3160	160	6 1/4"	240	986,50
3700 16 3180	180	7 1/8"	255	1.149,75

3700

**1000V İzoleli Elektrikçi Yan Keski**  
Insulated Electrician Type Side Cutter 1000V

TS 60  
TS ISO 5749  
DIN ISO 5749  
1000 V  
IEC 60900



Özel alaşımli çelik, Kesici ağızlar indüksiyonda sertleştirilmiş, Krom kaplı  
Special steel, Cutters induction hardened, Chrom plated

KOD CODE	L mm	L inch	g	TL/Ad.
3700 16 6140	140	5 1/2"	165	1.033,25
3700 16 6160	160	6 1/4"	215	1.172,50
3700 16 6180	180	7 1/8"	225	1.311,75

13000 005119

**Yan Keski Black Line**  
Side Cutting Pliers



TS 60 - TS ISO 5749  
DIN ISO 5749



Özel alaşımli çelik, Mangan fosfat kaplı,  
Kesici ağızlar indüksiyonda sertleştirilmiş  
Special steel, Phosphate finish, Cutters induction hardened

KOD CODE	L mm	L inch	g	TL/Ad.
13000 005119	160	6 1/4"	230	1.320,00

13000 005133

**Black Line Set (5 Parça)**  
Black Line Set (5 Pcs)



KOD CODE	İÇERİK CONTENTS		TL/Ad.
13000 005118	Kombine Pense 180 mm Combination Pliers	1	4.238,75
13000 005117	Kargaburun Düz Uçlu 180 mm Long Nose Pliers (Flat)	1	
13000 005119	Yan Keski 160 mm Side Cutting Pliers	1	
13000 005116	Düz Uçlu Tornavida 6x100 Screwdriver Flat	1	
13000 005120	Yıldız Uçlu Tornavida 6x100 Screwdriver Phillips	1	

**İnce Uçlu Yan Keski (Plastikler İçin)**  
 Side Cutter For Plastics

 TS 60  
 TS ISO 5749

 Özel alaşımlı çelik, Kesici ağızlar indüksiyonda sertleştirilmiş, PVC izoleli  
 Special steel, Cutters induction hardened, PVC insulated

KOD CODE	L mm	L inch	g	TL/Ad.
3705 16 5160	160	6 1/4"	220	5 1.067,00

**Yan Keski Ağır Tip (Çelik Tel İçin)**  
 Side Cutter Heavy Duty (for piano wire)

 Özel alaşımlı çelik, Kesici ağızlar indüksiyonda sertleştirilmiş  
 Special steel, Cutters induction hardened

KOD CODE	L mm	L inch	g	TL/Ad.
3730 16 2160	160	6 1/4"	200	5 1.163,00
3730 16 2200	200	8"	320	5 1.511,00

**Segman Pense Takımı (4 Parça)**  
 Circlip Pliers Set (4 Pcs)

İZELTAS YOUTUBE

KOD CODE	L mm	İÇERİK CONTENTS	TL/ Ad.
3301 12 0180	180	Dış Segman Pense (Düz) Circlip Pliers, External (Flat)	1
3311 12 0170	170	Dış Segman Pense (Eğri) Circlip Pliers, External (Bent)	1
3321 12 0180	180	İç Segman Pense (Düz) Circlip Pliers, Internal (Flat)	1 3.265,75
3331 12 0170	170	İç Segman Pense (Eğri) Circlip Pliers, Internal (Bent)	1

 330112 0180  
 Dış Segman Pense (Düz) ● 19-60

 3311 12 0170  
 Dış Segman Pense (Eğri) ● 19-60

 3321 12 0180  
 İç Segman Pense (Düz) ● 19-60

 3331 12 0170  
 İç Segman Pense (Eğri) ● 19-60





**3301**

**Dış Segman Pense (Düz)**  
Circlip Pliers, External (Flat)



TS 60  
DIN 5254

**Krom vanadyum, Krom kaplı, PVC izoleli**  
Chrom vanadium, Chrom plated, PVC insulated

KOD CODE	L mm		 g		TL/Ad.
3301 12 0140	140	10 - 25	90	5	769,25
3301 12 0180	180	19 - 60	195	5	811,25
3301 12 0225	225	40 - 100	235	5	1.014,00
3301 12 0295	295	85 - 140	445	5	1.718,50



**3321**

**İç Segman Pense (Düz)**  
Circlip Pliers Internal (Flat)



TS 60  
DIN 5256

**Krom vanadyum, Krom kaplı, PVC izoleli**  
Chrom vanadium, Chrom plated, PVC insulated

KOD CODE	L mm		 g		TL/Ad.
3321 12 0140	140	12 - 25	100	5	709,25
3321 12 0180	180	19 - 60	185	5	747,75
3321 12 0225	225	40 - 100	250	5	930,00
3321 12 0310	310	85 - 140	445	5	1.596,00



**3311**

**Dış Segman Pense (Eğri)**  
Circlip Pliers, External (Bent)



TS 60  
DIN 5254

**Krom vanadyum, Krom kaplı, PVC izoleli**  
Chrom vanadium, Chrom plated, PVC insulated

KOD CODE	L mm		 g		TL/Ad.
3311 12 0125	125	10 - 25	105	5	860,50
3311 12 0170	170	19 - 60	190	5	905,00
3311 12 0210	210	40 - 100	250	5	1.040,50
3311 12 0275	275	85 - 140	445	5	1.803,75



**3331**

**İç Segman Pense (Eğri)**  
Circlip Pliers Internal (Bent)



TS 60  
DIN 5256

**Krom vanadyum, Krom kaplı, PVC izoleli**  
Chrom vanadium, Chrom plated, PVC insulated

KOD CODE	L mm		 g		TL/Ad.
3331 12 0130	130	12 - 25	105	5	762,00
3331 12 0170	170	19 - 60	185	5	801,75
3331 12 0210	210	40 - 100	250	5	1.001,00
3331 12 0290	290	85 - 140	440	5	1.716,00

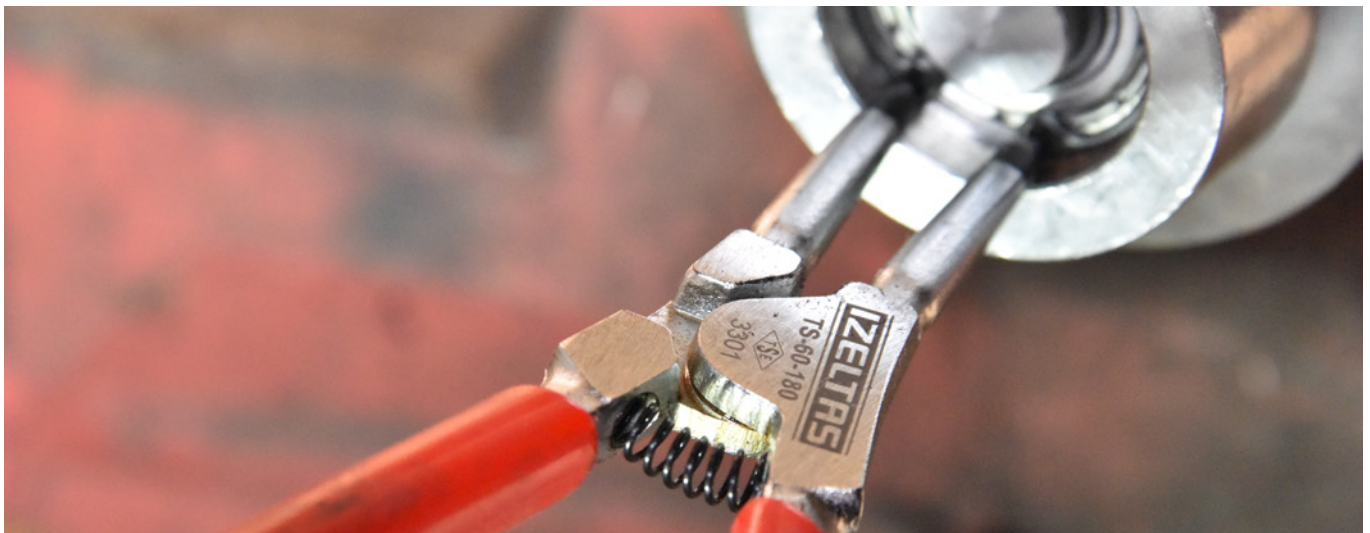

**3420 12 0220****Hortum Kelepçe Pensesi**  
Hose Clamp Pliers

KOD CODE	L mm	L inch	g	TL/Ad.	
3420 12 0220	220	8 3/4"	185	5	1.367,00

**3425 12 0220****Hortum Kelepçe Pensesi (Sıkıştırma Tipi)**  
Hose Clamp Pliers

KOD CODE	L mm	L inch	g	TL/Ad.	
3425 12 0220	235	9 1/4"	355	5	1.400,50

**3852 24 0225****Delik Zimba**  
Revolving Punch PliersÖlçü / Size  $\emptyset 2 - \emptyset 2.5 - \emptyset 3 - \emptyset 3.5 - \emptyset 4 - \emptyset 4.5$ 

KOD CODE	L mm	L inch	g	TL/Ad.	
3852 24 0225	225	9"	270	5	957,75

**3720 16 0220****Çift Ağızlı Kablo Kesici**  
Cable Cutter, Double Cutter**YENİ TASARIM**  
NEW DESIGNÖzel alaşımli çelik, Kesici ağızlar indüksiyonda sertleştirilmiş, PVC izoleli  
Special steel, Cutters induction hardened, PVC insulated

KOD CODE	L mm	L inch	g	TL/Ad.	
3720 16 0220	200	8"	265	5	1.178,50



3715 16 0165

Tek Ağızlı Kablo Kesici  
Cable Cutter



Özel alaşımlı çelik, Kesici ağızlar indüksiyonda sertleştirilmiş, PVC izoleli  
Special steel, Cutters induction hardened, PVC insulated

KOD CODE	L mm	L inch	g		TL/Ad.
3715 16 0165	165	6 1/4	210	5	879,75

3715 16 6165

1000V İzoleli Tek Ağızlı Kablo Kesici  
Cable Cutter 1000V

⚡ 1000 V  
IEC 60900



Özel alaşımlı çelik, Kesici ağızlar indüksiyonda sertleştirilmiş  
Special steel, Cutters induction hardened

KOD CODE	L mm	L inch	g		TL/Ad.
3715 16 6165	165	6 1/4	230	5	1.035,75



**3550 14 0125****Elektronikçi Yan Keski**

Electronic Diagonal Side Cutting Pliers

Özel alaşımli çelik  
Special steel

KOD CODE	L mm	g	TL/Ad.
3550 14 0125	125	76	5 933,75

**3553 14 0150****Elektronikçi Düz Uçlu Kargaburun**

Electronic Flat Nose Pliers

Özel alaşımli çelik  
Special steel

KOD CODE	L mm	g	TL/Ad.
3553 14 0150	150	88	5 842,50

**3551 14 0125****Elektronikçi Tepe Keski**

Electronic End Cutting Pliers

Özel alaşımli çelik  
Special steel

KOD CODE	L mm	g	TL/Ad.
3551 14 0125	125	77	5 871,25

**3554 14 0150****Elektronikçi Uzun Kargaburun**

Electronic Long Nose Pliers

Özel alaşımli çelik  
Special steel

KOD CODE	L mm	g	TL/Ad.
3554 14 0150	150	88	5 842,50

**3552 14 0125****Elektronikçi Yuvarlak Uçlu Kargaburun**

Electronic Round Nose Pliers

Özel alaşımli çelik  
Special steel

KOD CODE	L mm	g	TL/Ad.
3552 14 0125	125	78	5 846,00

**3555 14 0150****Elektronikçi Sivri Uçlu Düz Kargaburun**

Electronic Needle Flat Nose Pliers

Özel alaşımli çelik  
Special steel

KOD CODE	L mm	g	TL/Ad.
3555 14 0150	150	86	5 842,50

**3556 14 0150**
**Elektronikçi Sivri Uçlu Eğri Kargaburun**  
 Electronic Needle Bent Nose Pliers

 Özel alaşımli çelik  
 Special steel

KOD CODE	L mm	g	□	TL/Ad.
3556 14 0150	150	85	5	842,50

**3557 14 0125**
**Elektronikçi Pense**  
 Electronic Pliers

 Özel alaşımli çelik  
 Special steel

KOD CODE	L mm	g	□	TL/Ad.
3557 14 0125	125	80	5	846,00

**3560 00 2104**
**Elektronikçi Keski ve Pense Seti (4 Parça)**  
 Electronic Cutter & Pliers Set (4 Pcs)

KOD CODE	L mm	İÇERİK CONTENTS	□	TL/Ad.
3550 14 0125	125	Elektronikçi Yan Keski Electronic Diagonal Side Cutting Pliers	1	3.493,50
3551 14 0125	125	Elektronikçi Tepe Keski Electronic End Cutting Pliers	1	
3554 14 0150	150	Elektronikçi Uzun kargaburun Electronic Long Nose Pliers	1	
3557 14 0125	125	Elektronikçi Pense Electronic Pliers	1	

**3565 00 2104**
**Elektronikçi Kargaburun Seti (4 Parça)**  
 Electronic Long Nose Pliers Set (4 Pcs)

KOD CODE	L mm	İÇERİK CONTENTS	□	TL/Ad.
3552 14 0125	125	Elektronikçi Yuvarlak Uçlu Kargaburun Electronic Round Nose Pliers	1	3.373,50
3553 14 0150	150	Elektronikçi Düz Uçlu Kargaburun Electronic Flat Nose Pliers	1	
3555 14 0150	150	Elektronikçi Sivri Uçlu Düz Kargaburun Electronic Needle Nose Pliers	1	
3556 14 0150	150	Elektronikçi Sivri Uçlu Eğri Kargaburun Electronic Bent Needle Nose Pliers	1	

3800

**Kerpeten**  
Carpenter Pincers



TS 60 - TS ISO 9243  
DIN ISO 9243



Özel alaşımli çelik, Kesici ağızlar indüksiyonda sertleştirilmiş,  
Mangan Fosfat Kaplı, PVC izoleli  
Special steel, Cutters induction hardened, Black finish, PVC insulated

KOD CODE	L mm	L inch	g		TL/Ad.
3800 15 0160	160	6 1/4"	220	5	785,50
3800 15 0180	180	7 1/8"	295	5	813,50
3800 15 0200	200	8"	330	5	967,50
3800 15 0250	250	10"	530	5	1.013,00

3830

**Betoncu Kerpeteni**  
Tower Pincers



TS 60 - TS ISO 9242  
DIN ISO 9242



Özel alaşımli çelik, Kesici ağızlar indüksiyonda sertleştirilmiş,  
Mangan Fosfat Kaplı, PVC izoleli  
Special steel, Cutters induction hardened, Black finish, PVC insulated

KOD CODE	L mm	L inch	g		TL/Ad.
3830 15 0225	225	9"	345	5	836,50
3830 15 0250	250	10"	395	5	924,00
3830 15 0280	280	11"	450	5	1.103,00

3831 15 0280

**Betoncu Kerpeteni Yaylı**  
Tower Pincers with spring



TS 60 - TS ISO 9242  
DIN ISO 9242



Özel alaşımli çelik, Kesici ağızlar indüksiyonda sertleştirilmiş,  
Mangan Fosfat Kaplı, PVC izoleli  
Special steel, Cutters induction hardened, Black finish, PVC insulated

KOD CODE	L mm	L inch	g		TL/Ad.
3831 15 0280	280	11"	455	5	1.106,50

3835 15 0280

**Ağır Tip Betoncu Kerpeteni**  
Heavy Tower Pincers

TS 60 - TS ISO 9242  
DIN ISO 9242



İZELTAS YOUTUBE

Özel alaşımli çelik, Kesici ağızlar indüksiyonda sertleştirilmiş,  
Mangan Fosfat Kaplı, PVC izoleli  
Special steel, Cutters induction hardened, Black finish, PVC insulated

KOD CODE	L mm	L inch	g		TL/Ad.
3835 15 0280	280	11"	400	5	1.097,00

3850 12 0200

**Danallya**  
Shoemaker Pliers



Özel alaşımli çelik, İndüksiyonda sertleştirilmiş  
Special steel, Induction hardened

KOD CODE	L mm	L inch	g		TL/Ad.
3850 12 0200	200	8"	360	5	1.362,00



**IZELTAS®**

# 1000V İZOLELİ ALETLER

1000V INSULATED TOOLS



İZELTAS YOUTUBE

## VDE BELGELİ ÜRÜNLERİMİZ / VDE CERTIFIED PRODUCTS



- » El aletleri sektörünün lider markası İZELTAS'ın VDE belgeli ürünleri elektrik sektöründe fark yaratıyor.
- Bu ürünler elektrik sektöründe 1000V izolasyon sağlamak için özel olarak tasarlanmış yanmaz sapları ile kullanıcıya güven verir.
  - Elektrik akımının bulunduğu alanlarda güvenli kullanım sağlar.
  - Yanma, 1000V elektrik direnci, soğuk ve sıcak havalarda sap sökme deneyleri başta olmak üzere pek çok özel testten geçirilen ürünler, Alman VDE firmasından onaylıdır.
  - Ergonomik sap tasarımı ile tutuş ve kullanım kolaylığı sağlar.



- » As the leading brand in hand tools sector, CDE certified products of İZELTAS make a difference in electrical sector.
- These products assure the user with their handles specially designed to provide isolation up to 1000 V.
  - They provide safe use in areas with electrical current.
  - The products are certified by German VDE institution, being subjected to various tests particularly including fire resistance, 1000 V electrical resistance and handle detachment tests in hot and cold air conditions.
  - They provide ease of grip and use with an ergonomic design.



### Çalışma sırasında nelere dikkat edilmelidir?

- Elektrik akımının var olduğu alanlarda yalnızca özel eğitilmiş ve alanında uzman kişiler çalışmalıdır.
- Her kullanım öncesinde VDE belgeli ürünlerde ve izolelerinde hasar olup olmadığı kontrol edilmelidir.
- VDE belgeli ürünler amacı dışında ya da birleştirilerek kullanılmamalıdır.
- VDE belgeli ürünler ile koruyucu ekipmanlarınızı da güvenlik amacıyla kullanmalısınız.



### Important points for use

- Only specially trained and expert personnel should engage in work in areas with electrical current.
- Before each use VDE certified products and their isolation materials should be checked against damage.
- VDE certified products should not be used outside their purpose or in combination.
- Protective equipment should also be used to protect personnel in addition to VDE certified products.



**VDE belgeli ürünlerimiz,  
ilgili uluslararası standartlara göre  
kontrol edildikten sonra ek olarak  
beş ayrı teste tabi tutulur**

**Our VDE certified products  
are controlled in accord with the applicable  
international standards and then are  
subjected to five different tests:**

» 1- Voltaj Testi: 3 dakika boyunca 10.000V'a tabi tutulan izoleli el aletinde kaçak yada elektrik akımı atlama olmamalıdır.

» 1- Voltage Test: No residual current or electrical arc should be seen on the isolated hand tool subjected to 10,000 V for 3 minutes.

2- Soğuk Şoklama Testi : -24 derece 2 saat bekletilmiş (şoklanmış) el aletine 60-80 cm yükseklikten 600gr ağırlık ile darbeler uygulanır. İzolede kırılma ya da çatlama olmamalıdır.

2- Cold Shock Test: Hand tools left in -24 °C for 2 hours (shocked) are subjected to impacts with a 600 gr weight dropped from a height of 60-80 cm. No breakage or cracking should be seen on the isolation material.

3- Dayanıklılık Testi: +70 derece 1 hafta bekletilmiş el aletine 50kg yük ile sap sökme testi uygulanır. Sap yerinden çıkamamalıdır.

3- Durability Test: Hand tools left in +70 °C for 1 week are subjected to handle detachment test with a load of 50 kg. The handle should not detach.

4- Geçirgenlik Testi: 5000V elektrik akımına karşı 3 dakika boyunca 2kg sivri uçlu ağırlıkta baskı yapılarak elektrik verilir. Kaçak ya da elektrik atlama olmamalıdır.

4- Perviousness Test: Pointed tips under 2 kg load are used to apply 5000 V electrical current for 3 minutes. There should be no residual current or electrical arc.

5- Yanma Testi: Yüksek yoğunluktaki alev 20 saniye maruz bırakılarak teste tabi tutulur. Alevden uzaklaştırılan izole yanmaya devam etmemelidir.

5- Fire Test: The tool is subjected to high intensity flames for 20 seconds. After contact with the flame is ended the isolation material should not continue burning.

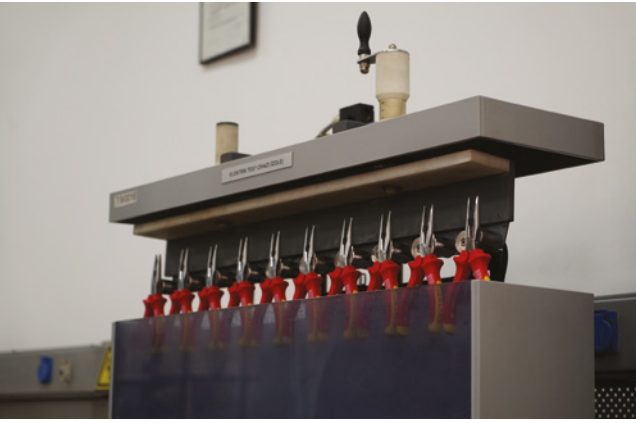



**Güçlü kavrama sağlayan  
tırnaklı tutma yüzeyleri**  
Toothed surface for strong grip

**Isıl işlem sonrasında indüksiyonda  
sertleştirme ile kullanım  
ömrü artırılmış kesici ağızlar**  
Heat-treated and induction hardened cutting  
edges for long lifetime

**Nikel üzerine krom kaplama ile  
korozyon direncinde  
üst seviye koruma**  
High corrosion resistance  
with chrome over nickel plating

**Yüksek karbonlu  
sıcak dövme çeliği  
ile artırılmış  
dayanım**  
High carbon forged steel  
for improved durability

**VDE/GS belgeli, 1000V dayanımlı,  
sert plastikten ve konforlu tutuş  
sağlayan yumuşak elastomer  
malzemeden imal edilmiş  
dayanımı yüksek çift  
komponentli ergonomik sap**  
VDE/GS certified, insulated for 1000V  
usage. Two component ergonomic  
handle with high strength and  
soft grip plastic



İZELTAS YOUTUBE

**0255**
**Süper İzole Çatal Bir Ağız Anahtar (mm)**  
 Single Ended Open Jaw Wrench  
 Super Insulated (mm)

 ⚡ 1000 V  
 IEC 60900

 Krom vanadyum, Krom kaplı, Kalın PVC izoleli  
 Chrom vanadium, Chrom plated, Triple PVC insulated

KOD CODE	mm	L mm	g		TL/Ad.
0255 01 0010	10	110	40	10	313,25
0255 01 0011	11	120	45	10	331,25
0255 01 0012	12	130	50	10	347,00
0255 01 0013	13	140	60	10	373,25
0255 01 0014	14	155	75	10	386,50
0255 01 0017	17	170	100	10	474,00
0255 01 0019	19	185	150	10	555,75
0255 01 0022	22	200	200	10	747,75
0255 01 0024	24	220	280	10	914,50

**0435**
**Süper İzoleli Yıldız Bir Ağız Anahtar (mm)**  
 Single Ended Ring Wrench  
 Super Insulated (mm)

 ⚡ 1000 V  
 IEC 60900

 Krom vanadyum, Krom kaplı, Kalın PVC izoleli  
 Chrom vanadium, Chrom plated, Triple PVC insulated

KOD CODE	mm	L mm	g		TL/Ad.
0435 03 0010	10	170	100	10	417,75
0435 03 0011	11	175	110	10	417,75
0435 03 0012	12	180	130	10	474,00
0435 03 0013	13	185	150	10	474,00
0435 03 0014	14	190	180	10	498,00
0435 03 0017	17	205	220	10	564,00
0435 03 0019	19	220	270	10	672,00
0435 03 0022	22	245	310	10	737,00
0435 03 0024	24	270	420	10	984,00

**0600 01 0010**
**1000V İzoleli Kurbağacık Anahtar**  
 Insulated Electrician Type Adjustable  
 Wrench 1000V

 TS ISO 6787  
 ⚡ 1000 V  
 IEC 60900

**YENİ NEW**

 Krom vanadyum, Krom kaplı, Kalın PVC izoleli  
 Chrom vanadium, Chrom plated, Triple PVC insulated

KOD CODE	L mm	L inch	mm	g		TL/Ad.
0600 01 0010	260	10"	28	440	5	1.577,00

**1000V 1/2" Altı Köşe Lokma Anahtar (mm)**  
 Socket Wrench 6 Points 1000V (mm)

 TS ISO 2725-1  
 DIN 3124  
 ⚡ 1000 V  
 IEC 60900

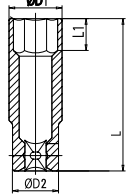
**YENİ NEW**

**1/2"**

 Krom vanadyum, Krom kaplı  
 Chrom vanadium, Chrom plated

KOD CODE	mm	σ D1 mm	σ D2 mm	L mm	L1 mm	g		TL/ Ad.
13000 005148	10	19,5	27	40	7	55	1	659,00
13000 005149	11	20,7	27	40	7	55	1	655,25
13000 005150	12	22	27	40	8	55	1	667,25
13000 005151	13	23,2	27	40	8	60	1	669,75
13000 005152	14	24,5	27	40	9	60	1	674,50
13000 005153	15	25,7	27	40	10	65	1	678,00
13000 005154	16	27	27	40	11	65	1	691,25
13000 005155	17	28,2	27	40	11	65	1	701,00
13000 005156	19	30,7	27	42	11	70	1	715,25
13000 005157	22	34,5	27	44	12	70	1	733,25
13000 005158	24	37	27	46	13	75	1	747,75
13000 005159	27	40,7	27	48	13	75	1	882,00

**13000 005277**
**1000V 1/2" Cırcır Kolu (36 Diş)**  
 Ratchet Handle 1000V (36 Teeth)

 ⚡ 1000 V  
 IEC 60900

**YENİ NEW**

**1/2"**

KOD CODE	L mm	g		TL/Ad.
13000 005277	275	540	1	6.356,50

**1000V 1/2" Ara Kol**  
Extension Bar 1000V

⚡ 1000 V  
IEC 60900

**YENİ  
NEW**



**1/2"**

**Krom vanadyum, Krom kaplı**  
Chrom vanadium, Chrom plated

KOD CODE	L mm	g		TL/Ad.
13000 005262	75	140	1	1.685,00
13000 005263	125	215	1	1.868,50
13000 005264	250	420	1	2.537,00

**13000 005541**

**1000V 1/2" T Kol**  
1000V Sliding T - Handle

⚡ 1000 V  
IEC 60900

**YENİ  
NEW**



**1/2"**

**Krom vanadyum, Krom kaplı**  
Chrom vanadium, Chrom plated

KOD CODE	L mm	g		TL/Ad.
13000 005541	200	660	5	1.549,25

**2400 11 6240**

**1000V İzoleli Üniversal Fort Pense**  
Insulated Type Waterpump  
Pliers Universal 1000V

TS 60  
TS ISO 8976  
⚡ 1000 V  
IEC 60900



**Krom vanadyum, Krom kaplı, çift komponent saplı**  
Chrom vanadium, Chrom plated, Two component handle

KOD CODE	L mm	L inch	mm	g		TL/Ad.
2400 11 6240	240	9 1/2"	35	370	5	1.221,75

**3715 16 6165**

**1000V İzoleli Tek Ağızlı Kablo Kesici**  
Cable Cutter 1000V

⚡ 1000 V  
IEC 60900



**Özel alaşımli çelik, Kesici ağızlar indüksiyonda sertleştirilmiş**  
Special steel, Cutters induction hardened

KOD CODE	L mm	L inch	g		TL/Ad.
3715 16 6165	165	6 1/4	150	5	1.035,75

**03753 50 026**

**Elektro Mekanik Kablo Sıyırıcı**  
Mechanical Cable Stripper

**YENİ  
NEW**



KOD CODE	ÖLÇÜ SIZE	g		TL/Ad.
03753 50 026	0.2 / 6	105	5	1.731,75



**3020**
**1000V İzoleli Elektrikçi Kombine Pense**  
 Insulated Electrician Type Combination Pliers 1000V

 TS 60  
 TS ISO 5746  
 DIN ISO 5746  
 ⚡ 1000 V  
 IEC 60900

 Özel alaşımli çelik, Kesici ağızlar indüksiyonda sertleştirilmiş, Krom kaplı  
 Special steel, Cutters induction hardened, Chrom plated

KOD CODE	L mm	L inch	g	□	TL/Ad.
3020 12 6160	160	6 1/4"	205	5	900,00
3020 12 6180	180	7 1/8"	260	5	965,00
3020 12 6200	200	8"	345	5	1.088,50

**3700**
**1000V İzoleli Elektrikçi Yan Keski**  
 Insulated Electrician Type Side Cutter 1000V

 TS 60  
 TS ISO 5749  
 DIN ISO 5749  
 ⚡ 1000 V  
 IEC 60900

 Özel alaşımli çelik, Kesici ağızlar indüksiyonda sertleştirilmiş, Krom kaplı  
 Special steel, Cutters induction hardened, Chrom plated

KOD CODE	L mm	L inch	g	□	TL/Ad.
3700 16 6140	140	5 1/2"	165	5	1.033,25
3700 16 6160	160	6 1/4"	215	5	1.172,50
3700 16 6180	180	7 1/8"	225	5	1.311,75

**3220**
**1000V İzoleli Elektrikçi Kargaburun Düz Uçlu**  
 Insulated Electrician Type Nose Pliers 1000V

 TS 60  
 TS ISO 5745  
 DIN ISO 5745  
 ⚡ 1000 V  
 IEC 60900

 Özel alaşımli çelik, Kesici ağızlar indüksiyonda sertleştirilmiş, Krom kaplı  
 Special steel, Cutters induction hardened, Chrom plated

KOD CODE	L mm	L inch	g	□	TL/Ad.
3220 13 6140	140	5 1/2"	110	5	921,75
3220 13 6160	160	6 1/4"	140	5	1.019,00
3220 13 6180	180	7 1/8"	160	5	1.143,75
3220 13 6200	200	8"	170	5	1.188,00

**3020 00 6003**
**1000V İzoleli Elektrikçi Seti (3 Parça)**  
 1000V Insulated Tool Set (3 Pcs)

KOD CODE	İÇERİK CONTENTS	□	TL/Ad.
3020 12 6160	160 mm 1000V İzoleli Elektrikçi Kombine Pense Insulated Electrician Type Combination Pliers	1	3.091,50
3220 13 6160	160 mm 1000V İzoleli Elektrikçi Kargaburun Düz Uçlu Insulated Electrician Type Nose Pliers	1	
3700 16 6160	160 mm 1000V İzoleli Elektrikçi Yan Keski Insulated Electrician Type Side Cutter	1	

4140

## 1000V İzoleli Elektrikçi Düz Uçlu Tornavida Insulated Electrician Type Flat Screwdriver 1000V

TS ISO 2380-1  
DIN ISO 2380-1  
⚡ 1000 V  
IEC 60900

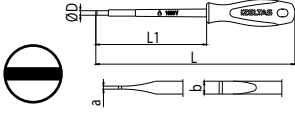

Krom vanadyum, Siyah oksit kaplı  
Chrom vanadium, Black finish

KOD CODE	øDxL1 mm	⊖		L mm	g	□	TL/Ad.
		a mm	b mm				
4140 17 2575	2.5x75	0.4	2.5	150	25	10	149,00
4140 17 4100	4x100	0.8	4	185	40	10	174,00
4140 17 5512	5.5x125	1	5.5	220	70	10	229,25
4140 17 6515	6.5x150	1.2	6.5	245	90	10	255,75

4145

## 1000V İzoleli Elektrikçi Yıldız Uçlu Tornavida Insulated Electrician Type Phillips Screwdriver 1000V

TS 59-5 ISO 8764  
DIN ISO 8764  
⚡ 1000 V  
IEC 60900

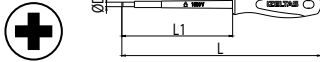

Krom vanadyum, Siyah oksit kaplı  
Chrom vanadium, Black finish

KOD CODE	øDxL1 mm	+	L mm	g	□	TL/Ad.
4145 18 0360	3x60	Ph0	135	25	10	155,00
4145 18 4580	4.5x80	Ph1	165	45	10	218,50
4145 18 6100	6x100	Ph2	195	70	10	255,75

4140 00 9106

## 1000V İzoleli Elektrikçi Tornavida Seti (6 Parça) Insulated Electrician Set (6 Pcs) Screwdriver 1000V



KOD CODE	İÇERİK CONTENTS	g	□	TL/Ad.
4140 00 9106	⊖ 2.5x75 - 4x100	340	6	1.282,25
	⊖ 5.5x125 - 6.5x150			
	⊖ Düz uçlu / Flat			
	⊕ 4.5x80 - 6x100			
	⊕ Yıldız uçlu / Phillips			

4773

## 1000V Süngüsü İzoleli Lokma Uçlu Tornavida Nut Spinner, Electrician Blade Insulated 1000V

⚡ 1000 V  
IEC 60900

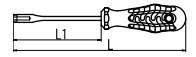

Krom vanadyum, iki komponent saplı  
Chrome vanadium, Two component handle

KOD CODE	⊖ mm	L mm	L1 mm	g	□	TL/Ad.
4773 19 0040	4	220	125	90	10	481,25
4773 19 0050	5	220	125	90	10	481,25
4773 19 0055	5.5	220	125	90	10	481,25
4773 19 0060	6	220	125	90	10	481,25
4773 19 0070	7	230	125	110	10	516,00
4773 19 0080	8	230	125	120	10	516,00
4773 19 0090	9	230	125	125	10	557,00
4773 19 0100	10	230	125	125	10	557,00
4773 19 0110	11	230	125	140	10	607,25
4773 19 0120	12	230	125	145	10	651,75
4773 19 0130	13	230	125	150	10	702,00
4773 19 0140	14	230	125	150	10	776,50

4773 00 8108

## 1000V Süngüsü İzoleli Lokma Uçlu Tornavida Takımı (8 Parça) Nut Spinner, Electrician Blade Insulated Set (8 Pcs) 1000V



KOD CODE	İÇERİK CONTENTS	g	□	TL/Ad.
4773 00 8108	6 - 7 - 8 - 9 - 10 - 11 - 12 - 13	2225	8	4.588,25

4783 19 6120

1000V Sngs İzoleli Manyetik Bits Tutucu Tornavida  
Screwdriver, Magnetic Bit Holder Insulated 1000V

⚡ 1000 V  
IEC 60900

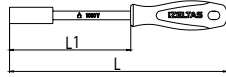

Krom vanadyum, iki komponent saplı  
Chrome vanadium, Two component handle

KOD CODE	mm	L mm	L1 mm	g	TL/Ad.
4783 19 6120	6.3	230	120	115	10 541,25



1000V İzoleli T Tipi Allen Anahtar (mm)  
Hex Key Wrench T - Handle Insulated 1000V

YENİ  
NEW

⚡ 1000 V  
IEC 60900

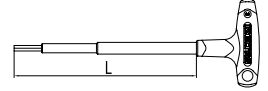

Krom vanadyum, iki komponent saplı  
Chrome vanadium, Two component handle

KOD CODE	mm	L mm	g	TL/Ad.
13000 005610	2.5	88	15	5 218,50
13000 005611	3	102	20	5 222,00
13000 005612	4	110	30	5 249,75
13000 005613	5	125	55	5 266,50
13000 005614	6	140	85	5 303,75
13000 005615	7	150	110	5 319,25
13000 005616	8	154	150	5 374,50
13000 005617	10	180	230	5 582,00

13000 008092

1000V İzoleli T Tipi Allen Anahtar Takımı (8 Parça)  
Hex Key Wrench T - Handle Set Insulated 1000V (8 Pcs)

YENİ  
NEW



KOD CODE	İÇERİK CONTENTS	g	TL/Ad.
13000 008092	2.5 - 3 - 4 - 5 6 - 7 - 8 - 10	695	8 2.535,75



**1000V İzoleli Elektro Slim Tornavida Seti (14 Parça)**  
**Insulated Electro Slim Screwdriver Set 1000V (14 Pcs)**
**ELEKTROSLIM**

**YENİ  
NEW**

KOD CODE	İÇERİK CONTENTS	g		TL/Ad
14000 005342	1000V İzoleli Elektro Slim Düz Uçlu Tornavida 2.5x75 - 3x100 - 3.5x100 - 4x100 - 5.5x100 - 6.5x100 Insulated Electro Slim Type Flat Screwdriver 1000V		6	2.995,25
	1000V İzoleli Elektro Slim Yıldız Uçlu Tornavida Ph1 - Ph2 Insulated Electro Slim Type Phillips Screwdriver 1000V		2	
	1000V İzoleli Elektro Slim Pozidriv Yıldız Uçlu Tornavida Pz2 Insulated Electro Slim Type Phillips Pozidriv Screwdriver 1000V	685	1	
	1000V İzoleli Elektro Slim Torx Uçlu Tornavida T10 - T15 - T20 Insulated Electro Slim Type Torx Screwdriver 1000V		3	
	1000V İzoleli Elektro Slim Oto Tornavida Sap Insulated Electro Slim Screwdriver Handle 1000V		1	
	1000V İzoleli Elektro Slim tornavida Klemens Tutucu Başlık Insulated Electro Slim Screwdriver Head 1000V		1	

**14000 005335**
**1000V İzoleli Elektro Slim Oto Tornavida Sap**  
**Insulated Electro Slim Screwdriver Handle 1000V**
 $\triangle$  1000 V  
IEC 60900

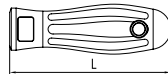
**YENİ  
NEW**

KOD CODE	L mm	g		TL/Ad
14000 005335	100	45	1	189,75

**14000 005334**
**1000V İzoleli Elektro Slim Klemens Tutucu Başlık**  
**Insulated Electro Slim Screwdriver Head 1000V**
 $\triangle$  1000 V  
IEC 60900

**YENİ  
NEW**

KOD CODE	g		TL/Ad
14000 005334	5	10	19,25

### 1000V İzoleli Elektro Slim Düz Uçlu Tornavida Insulated Electro Slim Type Flat Screwdriver 1000V

△1000 V  
IEC 60900

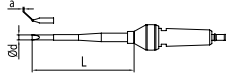

KOD CODE	Ød x L mm	a mm	g		TL/Ad
14000 005328	2.5x75	0,4	30	1	159,75
14000 005330	3x100	0,5	35	1	165,75
14000 005329	3.5x100	0,6	35	1	165,75
14000 005331	4x100	0,6	35	1	165,75
14000 005332	5.5x100	1	45	1	182,50
14000 005333	6.5x100	1,2	55	1	182,50

### 1000V İzoleli Elektro Slim Torx Uçlu Tornavida Insulated Electro Slim Type Torx Screwdriver 1000V

△1000 V  
IEC 60900

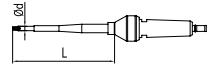

KOD CODE	Ød x L mm		g		TL/Ad
14000 005336	3,5x100	T10	35	1	165,75
14000 005337	3,5x100	T15	35	1	165,75
14000 005338	4,5x100	T20	40	1	165,75

### 1000V İzoleli Elektro Slim Yıldız Uçlu Tornavida Insulated Electro Slim Type Phillips Screwdriver 1000V

△1000 V  
IEC 60900

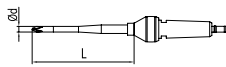

KOD CODE	Ød x L mm		g		TL/Ad
14000 005339	4,5x80	Ph1	50	1	174,00
14000 005340	6x100	Ph2	60	1	174,00

### 1000V İzoleli Elektro Slim Pozidriv Yıldız Uçlu Tornavida Insulated Electro Slim Type Phillips Pozidriv Screwdriver 1000V

△1000 V  
IEC 60900

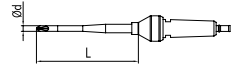

KOD CODE	Ød x L mm		g		TL/Ad
14000 005341	6x100	Pz2	60	1	174,00

**19" Plastik Takım Çantası Elektrikçi Set (23 Parça)**  
**Plastic Tool Box for Electrician 19" (23 Pcs)**

KOD CODE	İÇERİK CONTENTS	TL/ Ad.
8440 33 1019	19" Plastik Takım Çantası Plastic Tool Box	1
3700 16 6160	160 mm 1000V İzoleli Elektrikçi Yan Keski Insulated Electrician Type Side Cutter 1000V	1
3020 12 6180	180 mm 1000V İzoleli Elektrikçi Kombine Pense Insulated Electrician Type Combination Pliers 1000V	1
3220 13 6160	160 mm 1000V İzoleli Elektrikçi Kargaburun Düz Uçlu Insulated Electrician Type Nose Pliers 1000V	1
4773 19 0100	1000V Süngüsü İzoleli Lokma Uçlu Tornavida 10mm Nut Spinner, Electrician Blade Insulated 1000V	1
4773 19 0130	1000V Süngüsü İzoleli Lokma Uçlu Tornavida 13mm Nut Spinner, Electrician Blade Insulated 1000V	1
3715 16 6165	165mm 1000V İzoleli Elektrikçi Tek Ağız Kablo Kesici Cable Cutter 1000V	1
4520 18 0360	3x60 Klemens Yıldız Tornavida Electronic Screwdriver, Phillips	1 8.830,00
4520 18 0480	4x80 Klemens Yıldız Tornavida Electronic Screwdriver, Phillips	1
4500 17 0380	3x80 Klemens Düz Tornavida Electronic Screwdriver, Flat	1
4500 17 0480	4x80 Klemens Düz Tornavida Electronic Screwdriver, Flat	1
4140 17 4100	4x100 1000V İzoleli Elektrikçi Düz Tornavida Insulated Electrician Type Flat Screwdriver 1000V	1
4145 18 4580	4,5x80 1000V İzoleli Elektrikçi Yıldız Tornavida Insulated Electrician Type Phillips Screwdriver 1000V	1
4145 18 6100	6x100 1000V İzoleli Elektrikçi Yıldız Tornavida Insulated Electrician Type Phillips Screwdriver 1000V	1
4550 17 0190	190 mm Kontrol Kalemi Voltage Tester Flat	1
4560 18 0190	190 mm Yıldız Kontrol Kalemi Voltage Tester Phillips	1
4783 19 6120	6.3x120 1000V İzoleli Elektrikçi Manyetik Bits Tutucu Tornavida Screwdriver, Magnetic Bit Holder Insulated 1000V	1
4800 00 8106	6 li Bits Set ( 25 mm ) Bit Set 6 Pcs	6



13000 005538

**Elektro Takım Çantası (24 Parça)**  
Electro Tool Bag (24 Pcs)



KOD CODE	İÇERİK CONTENTS	☐	TL/Ad.
03752 50 625	Kablo Sıyırıcı Cable Stripper	1	
05881 50 005	Plastik Şerit Metre Plastic Steel Case, Measuring tapes	1	
3020 12 6180	1000V İzoleli Elektrikçi Kombine Pense 180mm Insulated Electrician Type Combination Pliers 1000V	1	
3220 13 6180	1000V İzoleli Elektrikçi Kargaburun Düz Uçlu 180mm Insulated Electrician Type Nose Pliers 1000V	1	
3700 16 6160	1000V İzoleli Elektrikçi Yan Keski 160mm Insulated Electrician Type Side Cutter 1000V	1	
4140	1000V İzoleli Elektrikçi Düz Uçlu Tornavida Insulated Electrician Type Flat Screwdriver 1000V 2.5x75 - 4x100 - 5.5x125	3	22.152,75
4145	1000V İzoleli Elektrikçi Yıldız Uçlu Tornavida Insulated Electrician Type Phillips Screwdriver 1000V 3x60 - 4.5x80 - 6x100	3	
4550 17 0190	Elektrik Kontrol Kalem 190mm (Düz Uçlu) Voltage Tester (Flat)	1	
13000 005263	1000V 1/2" Altı Köşe Lokma Anahtar (mm) Socket Wrench 6 Points 1000V (mm) 10 - 11 - 12 - 13 - 14 - 15 - 16 - 17 - 19	9	
13000 005277	1000V Ara Kol 125mm Extension Bar 1000V	1	
13000 005277	1000V 1/2" Cırcır Kolu (32 Diş) Ratchet Handle 1000V (32 Teeth)	1	

8795 00 6005

**1000V İzoleli Elektrikçi Seti (5 Parça)**  
1000V Insulated Tool Set (5 Pcs)



İZELTAS YOUTUBE



KOD CODE	İÇERİK CONTENTS	☐	TL/ Ad.
3020 12 6180	180 mm 1000V İzoleli Elektrikçi Kombine Pense Insulated Electrician Type Combination Pliers 1000V	1	
3220 13 6200	200 mm 1000V İzoleli Elektrikçi Kargaburun Insulated Electrician Type Nose Pliers	1	
3700 16 6160	160 mm 1000V İzoleli Elektrikçi Yan Keski Insulated Electrician Type Nose	1	3.810,50
4140 17 5512	5.5x125 1000V Elektrikçi Düz Uçlu Tornavida Insulated Electrician Type Flat Screwdriver 1000V	1	
4145 18 6100	6x100 1000V İzoleli Elektrikçi Yıldız Uçlu Tornavida Insulated Electrician Type Phillips Screwdriver 1000V	1	







**IZELTAS®**

# TORNAVİDA VE ALLEN ANAHTARLAR

SCREWDRIVERS AND HEX KEY WRENCHES

- Kontrol Kalemleri  
Testers
- Tornavidalar  
Screwdrivers
- Bits Uçlar ve Aparatları  
Bits
- Allen Anahtarlar  
Hex Key Wrenches



İZELTAS YOUTUBE





## ELEKTRİK KONTROL KALEMİ / VOLTAGE TESTER

**Tam sızdırmazlık sağlayan açılmayan pirinç kapak**  
Tightly pressed brass cover

**110V-220V arasında çalışan elektrik direnci ve kolay görünebilen neon lamba**  
Neon lamp working in the range of 110V-220V

**Elektrik yalıtkanlığı sağlayan, darbe dayanımı yüksek şeffaf sap**  
High insulation and impact resistant clear cellulose handle

**İzoleli süngü**  
Insulated blade

**Metal yüzeye basılı logo**  
Logo marked on the innermetal surface

**Yüksek tork mukavemetine sahip, alaşımli çelik (izolesiz uç kısmının uzunluğu15mm)**  
High torque strength alloyed steel ( non-insulated blade tip length 15mm)

**Nikel kaplama ile korozyon direncinde üst seviye koruma**  
High corrosion resistance with nickel plating

**Vida yuvalarına tam oturmayı sağlayan hassas işlenmiş uçlar**  
Precise machined slot to mate screw heads

**4550**
**Elektrik Kontrol Kalemı (Düz Uçlu)**  
 Voltage Tester (Flat)

TS 13108

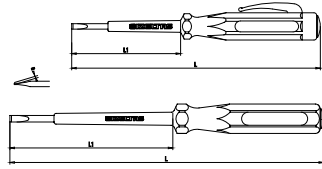
**Krom vanadyum, Nikel kaplı**  
 Chrom vanadium, Nickel plated

KOD CODE	L mm	⊖		L1 mm	g	□	TL/ Ad.
		a mm	b mm				
4550 17 0135	135	0.5	3	60	20	10	138,00
4550 17 0190	190	0.8	4	100	40	10	176,50

**4555 17 0165**
**Master Elektrik Kontrol Kalemı (Düz Uçlu)**  
 Voltage Tester Master (Flat)

TS 13108

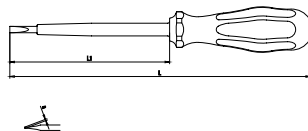
**Krom vanadyum, Nikel kaplı**  
 Chrom vanadium, Nickel plated

KOD CODE	L mm	⊖		L1 mm	g	□	TL/ Ad.
		a mm	b mm				
★ 4555 17 0165	165	0.5	3.5	88	40	10	189,75

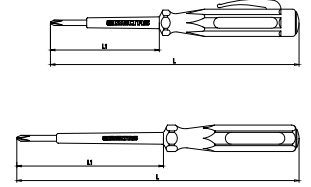
**4560**
**Elektrik Kontrol Kalemı (Yıldız Uçlu)**  
 Voltage Tester (Phillips)

**Krom vanadyum, Nikel kaplı**  
 Chrom vanadium, Nickel plated

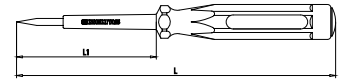
KOD CODE	L mm	L1 mm	⊕	g	□	TL/ Ad.
4560 18 0190	190	100	Ph0	40	10	207,75

**4565 17 0135**
**Oto Kontrol Kalemı**  
 Car Voltage Tester

**Krom vanadyum, Krom kaplı**  
 Chrom vanadium, Chrom plated

Tüm otomobil ve ağır vasıta araçlarda 6-24V arası elektrik tesisatının kontrol edilmesinde kullanılır. Sivri uçlu olması sebebiyle kablo ve soketleri yerinden sökmeden kontrol kolaylığı sağlar.

Tool is used to control 6-24V electrical wiring in all cars and heavy duty vehicles. With its point tip, wires and sockets are not required to be disassembled.

KOD CODE	L mm	L1 mm	●	Kablo L (m)	g	□	TL/ Ad.

★ Stoklarla Sınırlıdır / It is Limited by Stocks.

**Kraft Seri Düz Uçlu Tornavida**  
 Screwdriver, Kraft, Flat

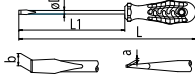
 TS ISO 2380 - 1  
 DIN ISO 2380-1

**Krom vanadyum, Krom kaplı, Ucu siyah oksit, Selüloz asetat saplı**  
 Chrom vanadium, Chrom plated and black tip, Cellulose acetate handle

KOD CODE	øDxL1 mm	⊖		L mm	g	□	TL/Ad.
		a mm	b mm				
4100 17 0340	3x40	0.5	3	105	20	10	116,50
4100 17 0380	3x80	0.5	3	155	35	10	123,75
4100 17 0480	4x80	0.8	4	165	50	10	133,25
4100 17 4100	4x100	0.8	4	185	50	10	153,75
4100 17 0580	5x80	1.0	5.5	175	70	10	163,25
4100 17 5100	5x100	1.0	5.5	195	75	10	179,00
4100 17 5125	5x125	1.0	5.5	220	80	10	204,00
4100 17 5150	5x150	1.0	5.5	245	80	10	223,25
4100 17 6100	6x100	1.2	6.5	195	85	10	182,50
4100 17 6125	6x125	1.2	6.5	220	90	10	210,00
4100 17 6150	6x150	1.2	6.5	245	95	10	230,50
4100 17 6175	6x175	1.2	6.5	270	100	10	295,25
4100 17 7125	7x125	1.2	8	230	120	10	233,00
4100 17 7150	7x150	1.2	8	255	130	10	269,00
4100 17 7175	7x175	1.2	8	280	135	10	308,50
4100 17 8150	8x150	1.6	10	255	145	10	306,00
4100 17 8175	8x175	1.6	10	280	150	10	326,50
4100 17 8200	8x200	1.6	10	305	160	10	399,75
4100 17 9200	9x200	2.0	12	305	190	10	425,00
4100 17 1125	11x250	2.5	14	365	305	10	540,00

**Kraft Seri Düz Uçlu Tornavida Takımı (8 Parça)**  
 Screwdriver, Flat, Kraft Set (8 Pcs)

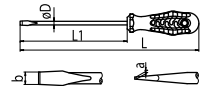
KOD CODE	İÇERİK CONTENTS	g	□	TL/ Ad.
4100 00 8108	3x80 - 4x80 - 4x100 5x100 - 5x125 - 6x100 6x125 - 6x150 ⊖ Düz uçlu / Flat	550	8	1.416,75

**Kraft Seri Süngüsü Uzun Düz Uçlu Tornavida**  
 Screwdriver, Kraft, Flat, Long

**Krom vanadyum, Krom kaplı, Ucu siyah oksit, Selüloz asetat saplı**  
 Chrom vanadium, Chrom plated and black tip, Cellulose acetate handle

KOD CODE	øDxL1 mm	⊖		L mm	g	□	TL/Ad.
		a mm	b mm				
4100 17 4300	4x300	0.8	4	385	70	10	375,75
4100 17 5250	5x250	1.0	5.5	345	95	10	421,25
4100 17 5350	5x350	1.0	5.5	445	115	10	474,00
4100 17 6350	6x350	1.2	6.5	445	125	10	503,00



4120

**Kraft Seri Yıldız Uçlu Tornavida**  
Screwdriver, Kraft, Phillips



TS 59 - 5 ISO 8764-1  
DIN ISO 8764-1

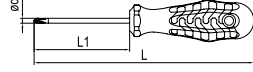

Krom vanadyum, Krom kaplı, Ucu siyah oksit, Selüloz asetat saplı  
Chrom vanadium, Chrom plated and black tip, Cellulose acetate handle

KOD CODE	ødxL1 mm	+	L mm	g	TL/Ad.
4120 18 0360	3x60	Ph0	135	30	131,00
4120 18 4580	4,5x80	Ph1	165	55	187,25
4120 18 5100	4,5x100	Ph1	185	55	209,00
4120 18 5150	4,5x150	Ph1	235	60	249,75
4120 18 6100	6x100	Ph2	195	85	224,50
4120 18 6150	6x150	Ph2	245	95	269,00
4120 18 6200	6x200	Ph2	295	105	349,25
4120 18 8150	8x150	Ph3	255	150	426,00
4120 18 1200	10x200	Ph4	315	240	657,75

4120

**Kraft Seri Süngüsü Uzun Yıldız Uçlu Tornavida**  
Screwdriver, Kraft, Phillips, Long

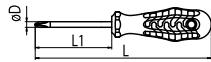

Krom vanadyum, Krom kaplı, Ucu siyah oksit, Selüloz asetat saplı  
Chrom vanadium, Chrom plated and black tip, Cellulose acetate handle

KOD CODE	øDxL1 mm	+	L mm	g	TL/Ad.
4120 18 5300	4,5x300	Ph1	385	80	587,00
4120 18 6300	6x300	Ph2	395	125	607,25

4120 00 8106

**Kraft Seri Yıldız Uçlu Tornavida Takımı (6 parça)**  
Screwdriver, Kraft, Phillips, Set (6 Pcs)



KOD CODE	İÇERİK CONTENTS	g	TL/Ad.
4120 00 8106	3x60 - 4,5x80 4,5x100 - 4,5x150 6x100 - 6x150 Yıldız uçlu / Phillips	380	6 1.270,50

4100 00 8107

**Kraft Seri Tornavida Seti (7 parça)**  
Screwdriver Set, Kraft (7 Pcs)



KOD CODE	İÇERİK CONTENTS	g	TL/Ad.
4100 00 8107	3x80 - 4x80 - 4x100 5x125 - 6x150 Düz uçlu / Flat 4,5x80 - 6x100 Yıldız uçlu / Phillips	445	7 1.257,00

4110

**Kraft Seri Düz Uçlu Topaç Tornavida**  
Screwdriver, Kraft, Stubby, Flat



TS ISO 2380-1

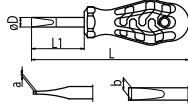

Krom vanadyum, Krom kaplı, Ucu siyah oksit, Selüloz asetat saplı  
Chrom vanadium, Chrom plated and black tip, Cellulose acetate handle

KOD CODE	σDxL1 mm	⊖		L mm	g	□	TL/Ad.
		a mm	b mm				
4110 17 5525	5.5x25	1	5.5	70	30	5	133,25
4110 17 5540	5.5x40	1	5.5	105	45	5	180,00
4110 17 6525	6.5x25	1.2	6.5	70	35	5	149,00
4110 17 6540	6.5x40	1.2	6.5	105	50	5	204,00

4130

**Kraft Seri Yıldız Uçlu Topaç Tornavida**  
Screwdriver, Kraft, Stubby, Phillips



TS 59-5 ISO 8764

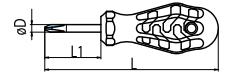

Krom vanadyum, Krom kaplı, Ucu siyah oksit, Selüloz asetat saplı  
Chrom vanadium, Chrom plated and black tip, Cellulose acetate handle

KOD CODE	σDxL1 mm	+	L mm	g	□	TL/Ad.
4130 18 4540	4.5x40	Ph1	105	40	5	179,00
4130 18 0625	6x25	Ph2	70	30	5	149,00
4130 18 0640	6x40	Ph2	105	50	5	201,75

13000 005116

**Black Line Düz Uçlu Tornavida**  
Screwdriver, Flat



TS ISO 2380-1  
DIN ISO 2380-1

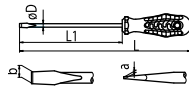

Krom vanadyum, Manganez fosfat kaplı, PP saplı  
Chrome vanadium, Phosphate finish, PP handle

KOD CODE	σDxL1 mm	⊖		L mm	g	□	TL/Ad.
		a mm	b mm				
13000 005116	6x100	1.2	6.5	195	65	10	258,00

13000 005120

**Black Line Yıldız Uçlu Tornavida**  
Screwdriver, Phillips



TS 59 - 5 ISO 8764-1  
DIN ISO 8764

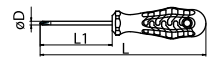

Krom vanadyum, Manganez fosfat kaplı, PP saplı  
Chrome vanadium, Phosphate finish, PP handle

KOD CODE	σDxL1 mm	+	L mm	g	□	TL/Ad.

4140

**1000V İzoleli Elektrikçi Düz Uçlu Tornavida**  
Insulated Electrician Type Flat  
Screwdriver 1000V

TS ISO 2380-1  
DIN ISO 2380-1  
⚡ 1000 V  
IEC 60900

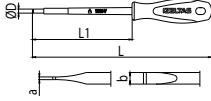

Krom vanadyum, Siyah oksit kaplı  
Chrom vanadium, Black finish

KOD CODE	øDxL1 mm	⊖		L mm	g	□	TL/Ad.
		a mm	b mm				
4140 17 2575	2.5x75	0.4	2.5	150	25	10	149,00
4140 17 4100	4x100	0.8	4	185	40	10	174,00
4140 17 5512	5.5x125	1	5.5	220	70	10	229,25
4140 17 6515	6.5x150	1.2	6.5	245	90	10	255,75

4145

**1000V İzoleli Elektrikçi Yıldız Uçlu Tornavida**  
Insulated Electrician Type Phillips  
Screwdriver 1000V

TS 59-5ISO 8764  
DIN ISO 8764  
⚡ 1000 V  
IEC 60900

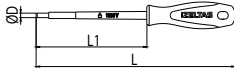

Krom vanadyum, Siyah oksit kaplı  
Chrom vanadium, Black finish

KOD CODE	øDxL1 mm	+	L mm	g	□	TL/Ad.
4145 18 4580	4.5x80	Ph1	165	45	10	218,50
4145 18 6100	6x100	Ph2	195	70	10	255,75

4140 00 9106

**1000V İzoleli Elektrikçi Tornavida Seti (6 Parça)**  
Insulated Electrician Set (6 Pcs) Screwdriver 1000V

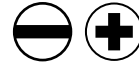

KOD CODE	İÇERİK CONTENTS	g	□	TL/ Ad.
4140 00 9106	2.5x75 - 4x100	340	6	1.282,25
	⊖ 5.5x125 - 6.5x150			
	Düz uçlu / Flat			
	⊕ 4.5x80 - 6x100			
	Yıldız uçlu / Phillips			





**1000V İzoleli Elektro Slim Tornavida Seti (14 Parça)**  
**Insulated Electro Slim Screwdriver Set 1000V (14 Pcs)**

**ELEKTROSLIM** ⚡



**YENİ  
NEW**



KOD CODE	İÇERİK CONTENTS	g		TL/Ad
14000 005342	<b>1000V İzoleli Elektro Slim Düz Uçlu Tornavida</b> 2.5x75 - 3x100 - 3.5x100 - 4x100 - 5.5x100 - 6.5x100 Insulated Electro Slim Type Flat Screwdriver 1000V		6	2.995,25
	<b>1000V İzoleli Elektro Slim Yıldız Uçlu Tornavida</b> Ph1 - Ph2 Insulated Electro Slim Type Phillips Screwdriver 1000V		2	
	<b>1000V İzoleli Elektro Slim Pozidriv Yıldız Uçlu Tornavida</b> Pz2 Insulated Electro Slim Type Phillips Pozidriv Screwdriver 1000V	685	1	
	<b>1000V İzoleli Elektro Slim Torx Uçlu Tornavida</b> T10 - T15 - T20 Insulated Electro Slim Type Torx Screwdriver 1000V		3	
	<b>1000V İzoleli Elektro Slim Oto Tornavida Sap</b> Insulated Electro Slim Screwdriver Handle 1000V		1	
	<b>1000V İzoleli Elektro Slim tornavida Klemens Tutucu Başlık</b> Insulated Electro Slim Screwdriver Head 1000V		1	

**14000 005335**

**1000V İzoleli Elektro Slim Oto Tornavida Sap**  
**Insulated Electro Slim Screwdriver Handle 1000V**

⚡1000 V  
IEC 60900

**YENİ  
NEW**

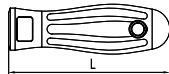

KOD CODE	L mm	g		TL/Ad
14000 005335	100	45	1	189,75

**14000 005334**

**1000V İzoleli Elektro Slim Klemens Tutucu Başlık**  
**Insulated Electro Slim Screwdriver Head 1000V**

⚡1000 V  
IEC 60900

**YENİ  
NEW**



KOD CODE	g		TL/Ad
14000 005334	5	10	19,25

### 1000V İzoleli Elektro Slim Düz Uçlu Tornavida Insulated Electro Slim Type Flat Screwdriver 1000V

±1000 V  
IEC 60900

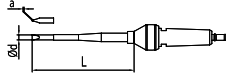

KOD CODE	Ød x L mm	a mm	g		TL/Ad
14000 005328	2.5x75	0,4	30	1	159,75
14000 005330	3x100	0,5	35	1	165,75
14000 005329	3.5x100	0,6	35	1	165,75
14000 005331	4x100	0,6	35	1	165,75
14000 005332	5.5x100	1	45	1	182,50
14000 005333	6.5x100	1,2	55	1	182,50

### 1000V İzoleli Elektro Slim Torx Uçlu Tornavida Insulated Electro Slim Type Torx Screwdriver 1000V

±1000 V  
IEC 60900

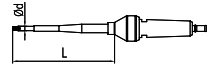

KOD CODE	Ød x L mm		g		TL/Ad
14000 005336	3,5x100	T10	35	1	165,75
14000 005337	3,5x100	T15	35	1	165,75
14000 005338	4,5x100	T20	40	1	165,75

### 1000V İzoleli Elektro Slim Yıldız Uçlu Tornavida Insulated Electro Slim Type Phillips Screwdriver 1000V

±1000 V  
IEC 60900

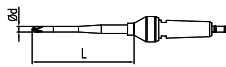

KOD CODE	Ød x L mm		g		TL/Ad
14000 005339	4,5x80	Ph1	50	1	174,00
14000 005340	6x100	Ph2	60	1	174,00

### 1000V İzoleli Elektro Slim Pozidriv Yıldız Uçlu Tornavida Insulated Electro Slim Type Phillips Pozidriv Screwdriver 1000V

±1000 V  
IEC 60900

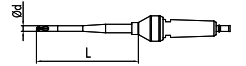

KOD CODE	Ød x L mm		g		TL/Ad
14000 005341	6x100	Pz2	60	1	174,00

4300

**Opak Seri Düz Uçlu Tornavida**  
Screwdriver, Opak, Flat



TS ISO 2380-1  
DIN ISO 2380-1

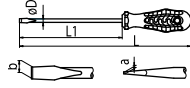

**Krom vanadyum, Krom kaplı, Ucu siyah oksit, PP saplı**  
Chrome vanadium, Chrom plated and black tip, PP handle

KOD CODE	σDxL1 mm	⊖		L mm	g	□	TL/Ad.
		a mm	b mm				
4300 17 0380	3x80	0.5	3	155	25	10	108,00
4300 17 0480	4x80	0.8	4	165	35	10	113,00
4300 17 4100	4x100	0.8	4	185	40	10	133,25
4300 17 5100	5x100	1.0	5.5	195	60	10	161,00
4300 17 5125	5x125	1.0	5.5	220	60	10	187,25
4300 17 6100	6x100	1.2	6.5	195	65	10	168,00
4300 17 6125	6x125	1.2	6.5	220	70	10	191,00
4300 17 6150	6x150	1.2	6.5	245	80	10	209,00
4300 17 7125	7x125	1.2	8	230	95	10	213,75
4300 17 7150	7x150	1.2	8	255	105	10	246,00
4300 17 8175	8x175	1.6	10	280	130	10	297,75
4300 17 9200	9x200	2.0	12	305	165	10	392,50

4320

**Opak Seri Yıldız Uçlu Tornavida**  
Screwdriver, Opak, Phillips



TS 59 - 5 ISO 8764-1  
DIN ISO 8764



**Krom vanadyum, Krom kaplı, Ucu siyah oksit, PP saplı**  
Chrome vanadium, Chrom plated and black tip, PP handle

KOD CODE	σDxL1 mm	+	L mm	g	□	TL/Ad.
4320 18 4580	4.5x80	Ph1	165	40	10	169,25
4320 18 6100	6x100	Ph2	195	70	10	205,25
4320 18 8150	8x150	Ph3	255	140	10	387,75

4300 00 8107

**Opak Seri Tornavida Seti (7 Parça)**  
Screwdriver Set, Opak (7 Pcs)

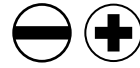

KOD CODE	İÇERİK CONTENTS	g	□	TL/Ad.

4325

**Opak Seri Pozidriv Yıldız Uçlu Tornavida**  
Screwdriver, Opak, Pozidriv

TS 59 - 5 ISO 8764-1  
DIN ISO 8764



**Krom vanadyum, Krom kaplı, Ucu siyah oksit, PP saplı**  
Chrome vanadium, Chrom plated and black tip, PP handle

KOD CODE	σDxL1 mm	+	L mm	g	□	TL/Ad.
4325 18 4580	4.5x80	Pz1	165	40	10	187,25
4325 18 6100	6x100	Pz2	195	70	10	224,50
4325 18 8150	8x150	Pz3	255	140	10	426,00



## 4240 17 0680

### Değişken Uçlu Tornavida Screwdriver - Reversible

TSEK



Krom vanadyum, Krom kaplı, Selüloz asetat saplı  
Chrom vanadium, Chrom plated, Cellulose acetate handle

KOD CODE	σDxL1 mm	⊖ axb mm	⊕	L mm	g	TL/Ad.	
4240 17 0680	6x80	1.2x6	Ph2	175	80	10	235,25

## 4240 00 7102

### Değişken Uçlu Tornavida Takımı Screwdriver Set - Reversible

TSEK



KOD CODE	σDxL1 mm	⊖ axb mm	⊕	L mm	g	TL/Ad.	
4240 00 7102	6x80	1.2x6	Ph2	175	105	1	403,25
	4.5x80	0.65x4.5	Ph1				

## 4500

### Elektronikçi Tip (Klemens) Düz Uçlu Tornavida Electronic Screwdriver, Flat



Krom vanadyum, Krom kaplı, Ucu siyah oksit, PP saplı  
Chrome vanadium, Chrom plated and black tip, PP handle

KOD CODE	σDxL1 mm	⊖		L mm	g	TL/Ad.	
		a mm	b mm				
4500 17 2560	2.5x60	0.4	2.5	140	15	10	104,50
4500 17 2580	2.5x80	0.4	2.5	160	15	10	110,50
4500 17 0380	3x80	0.5	3	160	15	10	116,50
4500 17 3100	3x100	0.5	3	180	20	10	143,00
4500 17 3125	3x125	0.5	3	205	20	10	187,25
4500 17 3510	3.5x100	0.6	3.5	180	20	10	146,50
4500 17 0480	4x80	0.8	4	160	20	10	120,00
4500 17 4100	4x100	0.8	4	180	20	10	146,50
4500 17 4125	4x125	0.8	4	205	25	10	197,00
4500 17 4150	4x150	0.8	4	230	25	10	213,75

## 4520

### Elektronikçi Tip (Klemens) Yıldız Uçlu Tornavida Electronic Screwdriver, Phillips



Krom vanadyum, Krom kaplı, Ucu siyah oksit, PP saplı  
Chrome vanadium, Chrom plated and black tip, PP handle

KOD CODE	σDxL1 mm	⊕	L mm	g	TL/Ad.	
4520 18 0360	3x60	Ph0	140	15	10	123,75
4520 18 0480	4x80	Ph0	160	20	10	176,50
4520 18 4150	4x150	Ph0	230	25	10	235,25

## 4500 00 8106

### Elektronikçi Tip (Klemens) Tornavida Seti (6 Parça) Electronic Screwdriver Set (6 Pcs)

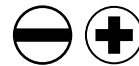

KOD CODE	İÇERİK CONTENTS	g	TL/Ad.
4500 00 8106	3x80 - 3x100	115	6
	3x125 - 4x150		
	Düz uçlu / Flat		
	3x60 - 4x80		
	Yıldız uçlu / Phillips		

4530

**Elektronikçi Tip (Klemens) Torx® Uçlu Tornavida**  
Electronic Screwdriver, Torx®

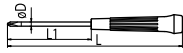

**Krom vanadyum, Krom kaplı, Ucu siyah oksit, PP saplı**  
Chrome vanadium, Chrom plated and black tip, PP handle

KOD CODE	ØDxL1 mm	★	L mm	g	□	TL/Ad.
4530 17 0560	2.5x60	T5	145	15	10	143,00
4530 17 0660	2.5x60	T6	145	15	10	143,00
4530 17 0760	3x60	T7	145	15	10	147,75
4530 17 0860	3x60	T8	145	20	10	147,75
4530 17 0960	3x60	T9	145	20	10	147,75
4530 17 1060	3.5x60	T10	145	20	10	147,75

4530 00 1006

**Elektronikçi Tip (Klemens) Torx® Uçlu Tornavida Takımı (6 Parça)**  
Electronic Screwdriver Set Torx (6 Pcs)



KOD CODE	İÇERİK CONTENTS	g	□	TL/Ad.
4530 00 1006	T5 - T6 - T7 - T8 - T9 - T10	115	6	877,00

4540 19 0190

**Klips Sökme Tornavidası**  
Hupcap and Clip Remover

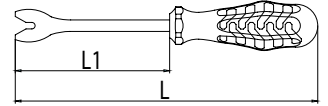

**Krom vanadyum, Krom kaplı, PP Saplı**  
Chrom vanadium, Chrom plated, PP insulated

KOD CODE	L mm	L1 mm	g	□	TL/Ad.
4540 19 0190	290	180	160	10	552,00

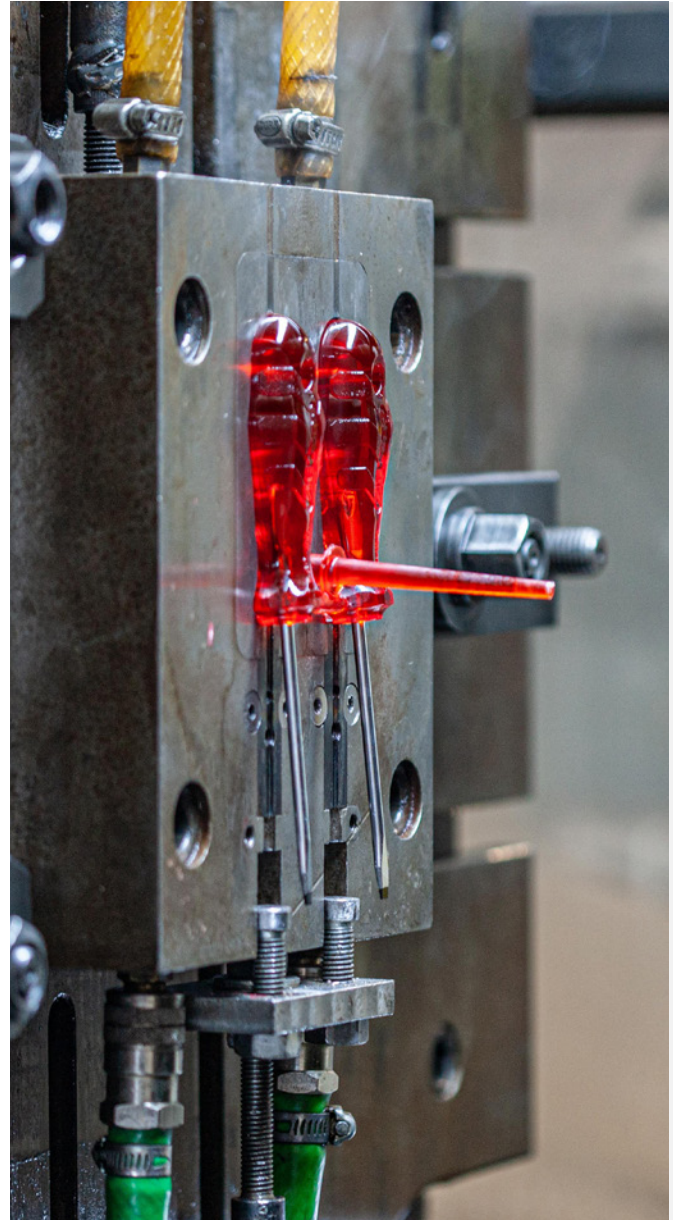

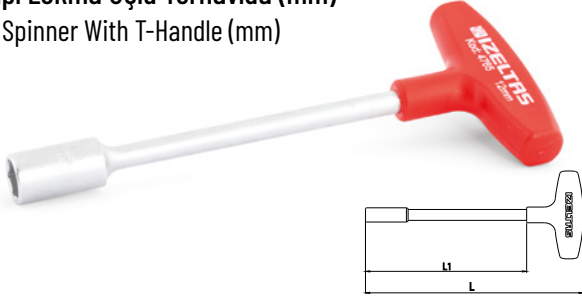
**4765**
**T Tipi Lokma Uçlu Tornavida (mm)**  
 Nut Spinner With T-Handle (mm)

 Krom vanadyum, Krom kaplı, PP Saplı  
 Chrom vanadium, Chrom plated, PP insulated

KOD CODE	mm	L mm	L1 mm	g	TL/Ad.
4765 19 0040	4	185	135	75	10 299,00
4765 19 0050	5	185	135	75	10 299,00
4765 19 0055	5.5	185	135	75	10 299,00
4765 19 0060	6	185	135	75	10 299,00
4765 19 0070	7	185	135	90	10 318,00
4765 19 0080	8	185	135	95	10 318,00
4765 19 0090	9	185	135	100	10 354,00
4765 19 0100	10	185	135	100	10 354,00
4765 19 0110	11	185	135	110	10 390,00
4765 19 0120	12	185	135	110	10 403,25
4765 19 0130	13	185	135	115	10 421,25
4765 19 0140	14	185	135	115	10 489,75

**4770**
**Lokma Uçlu Tornavida (mm)**  
 Nut Spinner (mm)

 TS 3793  
 DIN 3125

 Krom vanadyum, Krom kaplı, PP Saplı  
 Chrom vanadium, Chrom plated, PP insulated

KOD CODE	mm	L mm	L1 mm	g	TL/Ad.
4770 19 0040	4	220	125	80	10 339,75
4770 19 0050	5	220	125	80	10 339,75
4770 19 0055	5.5	220	125	80	10 339,75
4770 19 0060	6	220	125	80	10 339,75
4770 19 0070	7	230	125	100	10 365,00
4770 19 0080	8	230	125	110	10 365,00
4770 19 0090	9	230	125	115	10 392,50
4770 19 0100	10	230	125	115	10 392,50
4770 19 0110	11	230	125	130	10 429,75
4770 19 0120	12	230	125	135	10 461,00
4770 19 0130	13	230	125	140	10 495,75
4770 19 0140	14	230	125	140	10 548,50

**4770 00 8108**
**Lokma Uçlu Tornavida Takımı (8 Parça, mm)**  
 Nut Spinner Set (8 Pcs, mm)

KOD CODE	İÇERİK CONTENTS	g	TL/Ad.
4770 00 8108	6 - 7 - 8 - 9 - 10 - 11 - 12 - 13	2145	8 3.241,25



4773

1000V Sngs İzoleli Lokma Uçlu Tornavida (mm)  
Nut Spinner, Electrician Blade Insulated 1000V

± 1000 V  
IEC 60900



Krom vanadyum, İki Komponent Saplı  
Chrome vanadium, Two Component Insulated

KOD CODE	mm	L mm	L1 mm	g	TL/Ad.
4773 19 0040	4	220	125	90	10 481,25
4773 19 0050	5	220	125	90	10 481,25
4773 19 0055	5.5	220	125	90	10 481,25
4773 19 0060	6	220	125	90	10 481,25
4773 19 0070	7	230	125	110	10 516,00
4773 19 0080	8	230	125	120	10 516,00
4773 19 0090	9	230	125	125	10 557,00
4773 19 0100	10	230	125	125	10 557,00
4773 19 0110	11	230	125	140	10 607,25
4773 19 0120	12	230	125	145	10 651,75
4773 19 0130	13	230	125	150	10 702,00
4773 19 0140	14	230	125	150	10 776,50

4773 00 8108

1000V Sngs İzoleli Lokma Uçlu Tornavida Takımı  
(8 Parça, mm)

Nut Spinner, Electrician Blade Insulated Set (8 Pcs) 1000V



KOD CODE	İÇERİK CONTENTS	g	TL/Ad.
4773 00 8108	6 - 7 - 8 - 9 - 10 - 11 - 12 - 13	2225	8 4.588,25

4775

Torx® Uçlu Tornavida  
Torx® Screwdriver

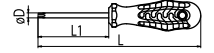

Krom vanadyum, Krom kaplı, Ucu siyah oksit, PP saplı  
Chrome vanadium, Chrom plated and blackened, PP handle

KOD CODE	øDxL1 mm	TL/Ad.	L mm	g	TL/Ad.
4775 18 0010	4x80	T10	165	35	10 169,25
4775 18 0015	4x80	T15	165	35	10 169,25
4775 18 0020	4x100	T20	185	40	10 187,25
4775 18 0025	4.5x100	T25	185	40	10 217,25
4775 18 0027	5x125	T27	220	60	10 239,00
4775 18 0030	6x125	T30	220	70	10 253,25
4775 18 0040	7x125	T40	230	100	10 315,75
4775 18 0045	8x125	T45	230	120	10 356,50

4775 008107

Torx® Uçlu Tornavida Takımı (7 Parça)  
Torx® Screwdriver Set (7 Pcs)



KOD CODE	İÇERİK CONTENTS	g	TL/Ad.
4775 00 8107	T10 - T15 - T20 - T25 - T27 - T30 - T40	380	7 1.551,00

**4776**

**Delikli Torx® Uçlu Tornavida**  
Torx® Screwdriver / Tamper Resistance

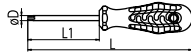

**Krom vanadyum, Krom kaplı, Ucu siyah oksit, PP saplı**  
Chrome vanadium, Chrom plated and blackened, PP handle

KOD CODE	σDxL1 mm	✦	L mm	g	□	TL/Ad.
4776 18 0009	4x60	TR9	145	35	10	219,75
4776 18 0010	4x80	TR10	165	35	10	227,00
4776 18 0015	4x80	TR15	165	40	10	227,00
4776 18 0020	4x100	TR20	185	40	10	253,25
4776 18 0025	4.5x100	TR25	185	45	10	291,75
4776 18 0027	5x125	TR27	220	60	10	321,75
4776 18 0030	6x125	TR30	220	70	10	342,00
4776 18 0040	7x125	TR40	230	100	10	422,50

**4776 00 8107**

**Delikli Torx® Uçlu Tornavida Takımı (7 Parça)**  
Torx® Screwdriver / Tamper Resistance Set (7 Pcs)



KOD CODE	İÇERİK CONTENTS	g	□	TL/Ad.
4776 00 8107	TR10 - TR15 - TR20 - TR25 - TR27 TR30 - TR40	380	7	2.085,25

**4780 19 6120**

**Manyetik Bits Tutucu Tornavida (Uzun)**  
Screwdriver, Magnetic Bit Holder (Long)



KOD CODE	mm	L mm	L1 mm	g	□	TL/Ad.
4780 19 6120	6.3	230	120	105	10	437,00

**4783 19 6120**

**1000V Süngüsü İzoleli Manyetik Bits Tutucu Tornavida**  
Screwdriver, Magnetic Bit Holder Insulated 1000V

⚡ 1000 V  
IEC 60900



KOD CODE	mm	L mm	L1 mm	g	□	TL/Ad.
4783 19 6120	6.3	230	120	115	10	541,25

**4785 19 6330**

**Manyetik Bits Tutucu Tornavida (Kısa)**  
Screwdriver, Magnetic Bit Holder, (Short)



KOD CODE	mm	L mm	L1 mm	g	□	TL/Ad.
4785 19 6330	6.3	130	30	60	10	239,00

**4790 26 6360**

**Üniversal Bits Adaptörü (Manyetik)**  
Screwdriver Universal Bit Holder (Magnetic)



KOD CODE	mm	mm	L mm	g	□	TL/Ad.
4790 26 6360	6.3	6.3	60	25	10	209,00

4795 19 0010

T Tipi Manyetik Bits Tutucu Tornavida  
Magnetic Bit Holder With T-Handle



KOD CODE	mm	L mm	L1 mm	g		TL/Ad.
4795 19 0010	6.3	180	130	60	10	463,25

4788 19 6160

Manyetik Bits Tutucu Tornavida, Flexible  
Screwdriver, Magnetic Bit Holder, Flexible



KOD CODE	mm	L mm	L1 mm	g		TL/Ad.
4788 19 6160	6.3	285	175	130	10	906,00

4805

Bits Uç Lokma Adaptörü (Makine Kullanımına Uygun)  
Socket Adapter

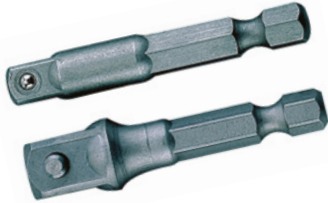

KOD CODE		L mm	g		TL/Ad.
4805 20 5010	1/4" M - 1/4" M	50	20	10	75,75
★ 4805 20 5011	1/4" M - 1/2" M	50	25	10	152,50

4815 00 6107

Değişken Bits Uçlu Tornavida Set (7 parça)  
Screwdriver - Interchangeable Bits Set (7 pcs)



KOD CODE	İÇERİK CONTENTS	g		TL/Ad.
4815 00 6107	100mm Sap - Handle Ph1x4.5 - Ph2x5.5 - Ph3x7 Pz1x4.5 - Pz2x5.5 - Pz3x7	140	7	503,00

4800 00 8106

6'lı Bits Uç Set  
Bit Set (6 Pcs)



KOD CODE	İÇERİK CONTENTS	g		TL/Ad.
4800 00 8106	0.6x4.5 - 0.8x5.5	50	6	177,25
	Ph1 - Ph2 - Ph3			
	T27			

4800 00 8110

10'lu Bits Uç Set  
Bit Set (10 Pcs)



KOD CODE	İÇERİK CONTENTS	g		TL/Ad.
4800 00 8110	0.6x4.5 - 0.8x5.5 1.2x6.5	55	10	326,75
	Ph1 - Ph2 - Ph3			
	T25 - T27 - T30 - T40			

4800 00 8131

31'li Bits Uç Set (Plastik Kutulu)  
Bit Set In Plastic Case (31 Pcs)

YENİ TASARIM  
NEW DESIGN



KOD CODE	İÇERİK CONTENTS	g		TL/Ad.
4800 00 8131	0.6x4.5 - 0.8x5.5	240	6 - 6	1.095,25
	1.2x6.5			
	Ph1			
	Ph2 - Ph3			
	T27			
	T25 - T30 - T40			
	6.3 x 60 Adaptör			

★ Stoklarla Sınırlıdır / It is Limited by Stocks.





13000 005429

**Cırcırlı Manyetik Bits Uç Tutucu Tornavida Seti (8 Parça)**  
Multi Bit Ratcheting Screwdriver Set (8 Pcs)

**YENİ  
NEW**



KOD CODE	İÇERİK CONTENTS	g		TL/Ad.
	6'lı Bits Set Bit Set (6 Pcs)			
	 0.6x4.5 - 0.8x5.5		6	
	 Ph1 - Ph2 - Ph3			
	 T27	340		940,75
13000 005278	Cırcırlı Manyetik Bits Tutucu Tornavida (175mm) Ratcheting Screwdriver (175mm)		1	
4790 26 6360	Üniversal Bits Adaptörü (Manyetik) Screwdriver Universal Bit Holder (Magnetic)		1	

13000 005278

**Cırcırlı Manyetik Bits Uç Tutucu Tornavida**  
Ratcheting Screwdriver

**YENİ  
NEW**



KOD CODE	mm	L mm	g		TL/Ad.
13000 005278	6.3	175	130	5	554,50

## 4810-4860

### Düz Bits Uçlar

Bits Flat

25mm-50mm-75mm-100mm-150mm



KOD CODE	⊖		L mm	g	□	TL/Ad.
	a mm	b mm				
4810 20 0645	0.6	4.5	25	5	10	26,50
4810 20 0855	0.8	5.5	25	5	10	26,50
4810 20 1265	1.2	6.5	25	5	10	26,50
4810 20 5645	0.6	4.5	50	10	10	42,00
4810 20 5855	0.8	5.5	50	10	10	42,00
4810 20 5265	1.2	6.5	50	10	10	42,00
4860 20 0745	0.6	4.5	75	11	10	63,75
4860 20 0755	0.8	5.5	75	13	10	63,75
4860 20 0765	1.2	6.5	75	15	10	63,75
4860 20 1045	0.6	4.5	100	14	10	95,00
4860 20 1055	0.8	5.5	100	17	10	95,00
4860 20 1065	1.2	6.5	100	18	10	95,00
4860 20 1545	0.6	4.5	150	21	10	134,50
4860 20 1555	0.8	5.5	150	26	10	134,50
4860 20 1565	1.2	6.5	150	28	10	134,50

## 4810

### Düz Bits Uç Takımı (10 Parça, 25 mm)

Flat Bit Set (10 Pcs., 25 mm)



KOD CODE	⊖	g	□	TL/Ad.
4810 00 0645	06x4.5	45	10	265,00
4810 00 0855	0.8x5.5	50	10	265,00
4810 00 1265	1.2x6.5	55	10	265,00

## 4820-4870

### Yıldız Bits Uçlar

Bits Phillips

25mm-50mm-75mm-100mm-150mm



KOD CODE	⊕	L mm	g	□	TL/Ad.
4820 21 0001	Ph1	25	5	10	27,75
4820 21 0002	Ph2	25	5	10	27,75
4820 21 0003	Ph3	25	5	10	27,75
4820 21 0011	Ph1	50	10	10	49,25
4820 21 0012	Ph2	50	10	10	49,25
4820 21 0013	Ph3	50	10	10	49,25
4870 21 0701	Ph1	75	17	10	66,00
4870 21 0702	Ph2	75	18	10	66,00
4870 21 0703	Ph3	75	18	10	66,00
4870 21 1001	Ph1	100	20	10	101,00
4870 21 1002	Ph2	100	24	10	101,00
4870 21 1003	Ph3	100	24	10	101,00
4870 21 1501	Ph1	150	23	10	141,75
4870 21 1502	Ph2	150	33	10	141,75
4870 21 1503	Ph3	150	33	10	141,75

## 4820

### Yıldız Bits Uç Takımı (10 Parça, 25 mm)

Phillips Bit Set (10 Pcs., 25 mm)



KOD CODE	⊕	g	□	TL/Ad.
4820 00 0001	Ph1	50	10	277,50
4820 00 0002	Ph2	50	10	277,50
4820 00 0003	Ph3	55	10	277,50

## 4825-4880

### Pozidriv Bits Uçlar

Bits Pozidriv

25mm-50mm-75mm-100mm-150mm



KOD CODE	+	L mm	g	□	TL/Ad.
4825 21 0001	Pz1	25	5	10	30,00
4825 21 0002	Pz2	25	5	10	30,00
4825 21 0003	Pz3	25	5	10	30,00
4825 21 0011	Pz1	50	10	10	53,00
4825 21 0012	Pz2	50	10	10	53,00
4825 21 0013	Pz3	50	10	10	53,00
4880 21 0701	Pz1	75	17	10	67,25
4880 21 0702	Pz2	75	18	10	67,25
4880 21 0703	Pz3	75	18	10	67,25
4880 21 1001	Pz1	100	20	10	102,00
4880 21 1002	Pz2	100	24	10	102,00
4880 21 1003	Pz3	100	24	10	102,00
4880 21 1501	Pz1	150	23	10	145,25
4880 21 1502	Pz2	150	33	10	145,25
4880 21 1503	Pz3	150	33	10	145,25

## 4830-4885

### Torx® Bits Uçlar

Bits Torx®

25mm-50mm-75mm-100mm-150mm



KOD CODE	★	L mm	g	□	TL/Ad.
4830 21 0025	T25	25	5	10	41,00
4830 21 0027	T27	25	5	10	41,00
4830 21 0030	T30	25	5	10	41,00
4830 21 0040	T40	25	5	10	41,00
4830 21 0125	T25	50	10	10	53,00
4830 21 0127	T27	50	10	10	53,00
4830 21 0130	T30	50	10	10	53,00
4830 21 0140	T40	50	10	10	53,00
4885 21 0725	T25	75	12	10	72,00
4885 21 0727	T27	75	15	10	72,00
4885 21 0730	T30	75	15	10	72,00
4885 21 0740	T40	75	17	10	72,00
4885 21 1025	T25	100	15	10	103,25
4885 21 1027	T27	100	20	10	103,25
4885 21 1030	T30	100	20	10	103,25
4885 21 1040	T40	100	23	10	103,25
4885 21 1525	T25	150	20	10	147,75
4885 21 1527	T27	150	25	10	147,75
4885 21 1530	T30	150	25	10	147,75
4885 21 1540	T40	150	33	10	147,75

## 4825

### Pozidriv Bits Uç Takımı (10 Parça, 25 mm)

Pozidriv Bit Set (10 Pcs., 25 mm)



KOD CODE	+	g	□	TL/Ad.
4825 00 0001	Pz1	50	10	300,00
4825 00 0002	Pz2	55	10	300,00
4825 00 0003	Pz3	55	10	300,00

## 4830

### Torx® Bits Uç Takımı (10 Parça, 25 mm)

Torx® Bit Set (10 Pcs., 25 mm)



KOD CODE	★	g	□	TL/Ad.
4830 00 0025	T25	50	10	410,00
4830 00 0027	T27	50	10	410,00
4830 00 0030	T30	55	10	410,00
4830 00 0040	T40	60	10	410,00



4784 19 6346

1/4"Avuç İçi Bits Uç Tutucu  
Palm Ratchet Bit Holder



KOD CODE	Ø	L mm	g	TL/Ad.
4784 19 6346	46	26,5	100	842,50

4850 00 1013

100mm Uzun Bits Uç Takımı (13 Parça)  
Bit Set, Long Type 100 mm (13 Pcs)



KOD CODE	İÇERİK CONTENTS	g	TL/Ad.
4850 00 1013	Düz Uçlar Flat Bits 0.6x4.5 - 0.8x 5.5 1.2x6.5	263	13
	Yıldız Uçlar Phillips Bits Ph1 - Ph2 - Ph3		
	Pozidriv Uçlar Pozidriv Bits Pz1 - Pz2 - Pz3		
	Torx® Uçlar Torx® Bits T25 - T27 - T30 - T40		
			1.307,00

4850 00 0713

75mm Uzun Bits Uç Takımı (13 Parça)  
Bit Set, Long Type 75 mm (13 Pcs)



KOD CODE	İÇERİK CONTENTS	g	TL/Ad.
4850 00 0713	Düz Uçlar Flat Bits 0.6x4.5 - 0.8x 5.5 1.2x6.5	204	13
	Yıldız Uçlar Phillips Bits Ph1 - Ph2 - Ph3		
	Pozidriv Uçlar Pozidriv Bits Pz1 - Pz2 - Pz3		
	Torx® Uçlar Torx® Bits T25 - T27 T30 - T40		
			879,00

4850 00 1513

150mm Uzun Bits Uç Takımı (13 Parça)  
Bit Set, Long Type 150 mm (13 Pcs)



KOD CODE	İÇERİK CONTENTS	g	TL/Ad.
4850 00 1513	Düz Uçlar Flat Bits 0.6x4.5 - 0.8x 5.5 1.2x6.5	356	13
	Yıldız Uçlar Phillips Bits Ph1 - Ph2 - Ph3		
	Pozidriv Uçlar Pozidriv Bits Pz1 - Pz2 - Pz3		
	Torx® Uçlar Torx® Bits T25 - T27 - T30 - T40		
			1.855,50

## 4900

### Allen Anahtar Altı Köşe Standart Boy (mm) Hex Key Wrench Standard Size (mm)



TS ISO 2936  
DIN ISO 2936

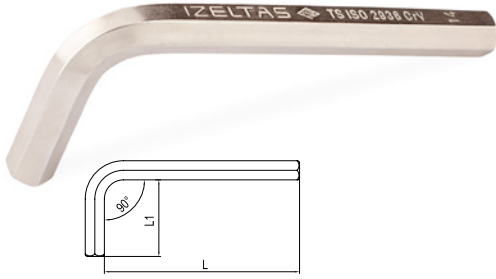

Krom Vanadyum, Nikel Kaplı  
Chrom Vanadium, Nickel Plated

KOD CODE	mm	L mm	L1 mm	g		TL/Ad.
4900 22 0015	1.5	45	14	1.5	10	15,75
4900 22 0020	2	50	16	2	10	21,75
4900 22 0025	2.5	56	18	4	10	27,75
4900 22 0030	3	63	20	6	10	29,00
4900 22 0035	3.5	66	22	8	10	37,25
4900 22 0040	4	70	25	10	10	37,25
4900 22 0050	5	80	28	20	10	43,25
4900 22 0060	6	90	32	30	10	56,50
4900 22 0070	7	95	34	40	10	83,00
4900 22 0080	8	100	36	55	10	95,00
4900 22 0090	9	105	38	75	10	116,50
4900 22 0100	10	112	40	100	10	144,00
4900 22 0120	12	125	45	160	10	207,75
4900 22 0140	14	140	56	250	5	331,25
4900 22 0160	16	152	60	375	5	609,75
4900 22 0170	17	160	63	425	5	657,75
4900 22 0190	19	180	70	610	5	812,50
4900 22 0220	22	200	80	940	5	1.357,25
4900 22 0240	24	224	90	1250	5	1.830,00

## 4900

### Allen Anahtar Takım Altı Köşe Standart Boy (mm) Hex Key Wrench Set Standard Size (mm)



YENİ TASARIM  
NEW DESIGN



KOD CODE	İÇERİK CONTENTS	g		TL/Ad.
4900 00 3110	2 - 2.5 - 3 - 4 - 5 - 6 7 - 8 - 9 - 10	400	10	654,00
4900 00 3112	2 - 2.5 - 3 - 3.5 - 4 - 5 6 - 7 - 8 - 9 - 10 - 12	565	12	899,00

## 4901

### Allen Anahtar Altı Köşe (SAE) Hex Key Wrench (SAE)

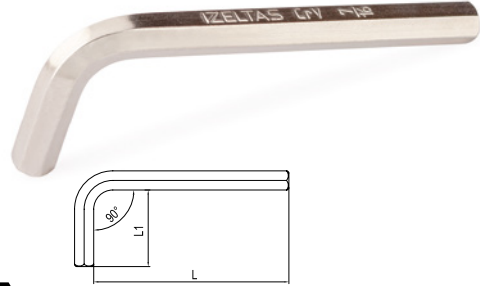

Krom Vanadyum, Nikel Kaplı  
Chrom Vanadium, Nickel Plated

KOD CODE	inch	L mm	L1 mm	g		TL/Ad.
4901 22 1984	5/64"	50	16	2	10	29,00
4901 22 2381	3/32"	54	18	4	10	31,25
4901 22 3125	1/8"	58	20	5	10	38,50
4901 22 3968	5/32"	62	22	10	10	45,75
4901 22 4762	3/16"	68	24	15	10	48,00
4901 22 5556	7/32"	74	26	25	10	62,50
4901 22 6350	1/4"	82	28	35	10	77,00
4901 22 7937	5/16"	94	32	55	10	95,00
4901 22 9825	3/8"	106	38	90	10	131,00
4901 22 1111	7/16"	118	42	130	10	175,25
4901 22 1270	1/2"	132	46	190	10	219,75
4901 22 1428	9/16"	144	52	265	10	320,50
4901 22 1587	5/8"	156	58	365	10	497,00
4901 22 1905	3/4"	176	66	600	5	695,00

## 4901

### Allen Anahtar Takım Altı Köşe (SAE) Hex Key Wrench Set (SAE)



KOD CODE	İÇERİK CONTENTS	g		TL/Ad.
4901 00 3110	5/64" - 3/32" - 1/8" - 5/32" 3/16" - 7/32" - 1/4" - 5/16" 3/8" - 7/16"	405	10	733,25
4901 00 3112	5/64" - 3/32" - 1/8" - 5/32" 3/16" - 7/32" - 1/4" - 5/16" 3/8" - 7/16" - 1/2" - 9/16"	855	12	1.273,50

4903

Allen Anahtar Altı Köşe Uzun Boy (mm)  
Hex Key Wrench Long Pattern (mm)



TS ISO 2936  
DIN ISO 2936



Krom Vanadyum, Nikel Kaplı  
Chrom Vanadium, Nickel Plated

KOD CODE	mm	L mm	L1 mm	g		TL/Ad.
4903 22 0020	2	100	16	3	10	31,25
4903 22 0025	2.5	112	18	5	10	37,25
4903 22 0030	3	126	20	10	10	42,00
4903 22 0035	3.5	136.5	22	15	10	51,75
4903 22 0040	4	140	25	20	10	53,00
4903 22 0050	5	160	28	30	10	59,00
4903 22 0060	6	180	32	50	10	95,00
4903 22 0070	7	190	34	80	10	140,50
4903 22 0080	8	200	36	100	10	152,50
4903 22 0090	9	210	38	145	10	206,50
4903 22 0100	10	224	40	180	10	255,75
4903 22 0120	12	250	45	285	10	366,00
4903 22 0140	14	280	56	460	5	589,25
4903 22 0160	16	290	60	625	5	953,00
4903 22 0170	17	320	63	750	5	1.038,00
4903 22 0190	19	360	70	1100	5	1.537,25

4903

Allen Anahtar Takım Altı Köşe Uzun Boy (mm)  
Hex Key Wrench Set Long Pattern (mm)



YENİ TASARIM  
NEW DESIGN



KOD CODE	İÇERİK CONTENTS	g		TL/Ad.
4903 00 3110	2 - 2.5 - 3 - 4 - 5 - 6 7 - 8 - 9 - 10	660	10	1.072,75
4903 00 3112	2 - 2.5 - 3 - 3.5 - 4 - 5 6 - 7 - 8 - 9 - 10 - 12	940	12	1.490,50

4905

Yuvarlak Başlı Allen Anahtar Standart Boy (mm)  
Hex Key Wrench Ballpoint (mm)



Krom Vanadyum, Nikel Kaplı  
Chrom Vanadium, Nickel Plated

KOD CODE	mm	L mm	L1 mm	g		TL/Ad.
4905 22 0020	2	50	16	3	10	35,00
4905 22 0025	2.5	56	18	4	10	42,00
4905 22 0030	3	63	20	5	10	48,00
4905 22 0040	4	70	25	10	10	59,00
4905 22 0050	5	80	28	20	10	62,50
4905 22 0060	6	90	32	30	10	99,75
4905 22 0080	8	100	36	55	10	152,50
4905 22 0100	10	112	40	100	10	242,50

4905 00 7108

Yuvarlak Başlı Allen Anahtar Takımı Standart Boy  
(8 Parça, mm)  
Hex Key Wrench Ballpoint Set (8 Pcs, mm)



KOD CODE	İÇERİK CONTENTS	g		TL/Ad.
4905 00 7108	2 - 2.5 - 3 - 4 5 - 6 - 8 - 10	275	8	741,25

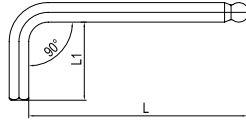

**4906**
**Yuvarlak Başlı Allen Anahtar Uzun Boy (mm)**  
**Hex Key Wrench Ballpoint Long Pattern (mm)**

**Krom Vanadyum, Nikel Kaplı**  
**Chrom Vanadium, Nickel Plated**

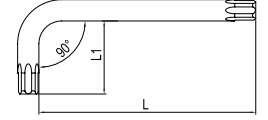
KOD CODE	mm	L mm	L1 mm	g	TL/ Ad.
4906 22 0015	1.5	79	12	1.5	10 47,00
4906 22 0020	2	84	16	3	10 62,50
4906 22 0025	2.5	89	16	5	10 67,25
4906 22 0030	3	99	18	7	10 72,00
4906 22 0040	4	109	23	13	10 83,00
4906 22 0050	5	125	26	25	10 103,25
4906 22 0060	6	150	28	42	10 119,00
4906 22 0080	8	167	33	85	10 188,50
4906 22 0100	10	190	37	150	10 279,75

**4910**
**Torx® Allen Anahtar**  
**Torx® Key Wrench**

**Krom Vanadyum, Nikel Kaplı**  
**Chrom Vanadium, Nickel Plated**

KOD CODE	☆	L mm	L1 mm	g	TL/ Ad.
4910 22 0006	T6	42	16	2	10 144,00
4910 22 0007	T7	48	16	2	10 144,00
4910 22 0008	T8	48	16	3	10 144,00
4910 22 0009	T9	48	16	3	10 145,25
4910 22 0010	T10	51	17	4	10 145,25
4910 22 0015	T15	54	18	5	10 149,00
4910 22 0020	T20	57	19	5	10 157,25
4910 22 0025	T25	60	20	10	10 157,25
4910 22 0027	T27	64	21	15	10 157,25
4910 22 0030	T30	70	24	20	10 168,00
4910 22 0040	T40	76	26	30	10 179,00
4910 22 0045	T45	83	29	40	10 218,50
4910 22 0050	T50	95	32	60	10 248,50
4910 22 0055	T55	108	35	125	10 344,50
4910 22 0060	T60	120	38	185	10 474,00

**4906 00 3109**
**Yuvarlak Başlı Allen Anahtar Takım Uzun Boy (9 parça, mm)**  
**Hex Key Wrench Ballpoint Long Pattern Set (9 Pcs, mm)**

KOD CODE	İÇERİK CONTENTS	g	TL/ Ad.
4906 00 3109	1.5 - 2 - 2.5 - 3 - 4 - 5 - 6 8 - 10	355	9 1.022,25

**4910 00 7108**
**Torx® Allen Anahtar Takımı (8 Parça)**  
**Torx® Key Wrench Set (8 Pcs)**

KOD CODE	İÇERİK CONTENTS	g	TL/ Ad.
4910 00 7108	T9 - T10 - T15 T20 - T25 - T27 T30 - T40	155	8 1.258,25

4912 00 3107

Kaset Allen Anahtar Takımı (7 Parça, mm)  
Hex Key Wrench Folding Set (7 Pcs, mm)



Krom vanadyum  
Chrom vanadium

KOD CODE	İÇERİK CONTENTS	g	TL/ Ad.
4912 00 3107	2.5 - 3 - 4 - 5 - 6 - 8 - 10	355	1 1.263,75

4912 00 0007

Kaset Allen Anahtar Takımı (7 Parça, mm)  
Hex Key Wrench Folding Set (7 Pcs, mm)



Krom vanadyum  
Chrom vanadium

KOD CODE	İÇERİK CONTENTS	g	TL/ Ad.
4912 00 0007	1.5 - 2 - 2.5 3 - 4 - 5 - 6	130	1 801,75

4909

T Tipi Torx® Allen Anahtar  
T Handle Torx® Key Wrench

YENİ TASARIM  
NEW DESIGN

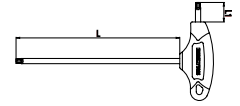

Krom vanadyum, Nikel kaplı, PP Saplı  
Chrom vanadium, Nickel plated, PP Handle

KOD CODE	☆	L mm	L1 mm	g	TL/ Ad.
4909 22 0009	T9	111.5	21	15	5 366,00
4909 22 0010	T10	111.5	21	15	5 373,25
4909 22 0015	T15	105	16	20	5 381,75
4909 22 0020	T20	105	16	25	5 384,00
4909 22 0025	T25	129	25	50	5 392,50
4909 22 0027	T27	129	25	50	5 437,00
4909 22 0030	T30	122	20	105	5 449,00
4909 22 0040	T40	153	35	100	5 465,75

4909 00 8108

T Tipi Torx Allen Anahtar Takımı (8 Parça)  
T Handle Torx Key Wrench Set (8 Pcs)



KOD CODE	İÇERİK CONTENTS	g	TL/ Ad.
4909 00 8108	T9 - T10 - T15 - T20 T25 - T27 - T30 - T40	407	8 3.249,25

**4920**
**T Tipi Allen Anahtar (mm)**  
 Hex Key Wrench T - Handle (mm)

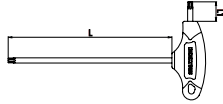
**YENİ TASARIM**  
 NEW DESIGN

**Krom Vanadyum, Krom Kaplı, PP Saplı**  
 Chrom Vanadium, Chrome Plated, PP Handle

KOD CODE	mm	L mm	L1 mm	g		TL/Ad.
4920 22 0025	2.5	102	17.5	10	5	198,00
4920 22 0030	3	118	21	15	5	201,75
4920 22 0040	4	131	24.5	35	5	227,00
4920 22 0050	5	141	22	50	5	241,25
4920 22 0060	6	154	26	85	5	276,00
4920 22 0070	7	174	36	120	5	289,25
4920 22 0080	8	184	34	165	5	341,00
4920 22 0100	10	209	45.5	260	5	515,00

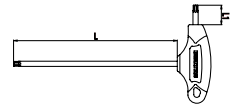
**4921**
**T Tipi Yuvarlak Başlı Allen Anahtar (mm)**  
 Hex Key Wrench T - Handle Ballpoint (mm)

**YENİ TASARIM**  
 NEW DESIGN

**Krom Vanadyum**  
 Chrom Vanadium

KOD CODE	mm	L mm	L1 mm	g		TL/Ad.
4921 22 0025	2.5	102	17.5	10	5	257,00
4921 22 0030	3	118	21	15	5	260,50
4921 22 0040	4	131	24.5	35	5	291,75
4921 22 0050	5	141	22	50	5	313,25
4921 22 0060	6	154	26	85	5	359,00
4921 22 0070	7	174	36	120	5	375,75
4921 22 0080	8	184	34	165	5	403,25
4921 22 0100	10	209	45.5	260	5	668,50

**4920 00 8108**
**T Tipi Allen Anahtar Takımı (8 Parça, mm)**  
 Hex Key Wrench T - Handle Set (8 Pcs, mm)

KOD CODE	İÇERİK CONTENTS	g		TL/Ad.
4920 00 8108	2.5 - 3 - 4 - 5 6 - 7 - 8 - 10	760	8	2.289,25

**4921 00 8108**
**T Tipi Yuvarlak Başlı Allen Anahtar Takımı (8 Parça, mm)**  
 Hex Key Wrench T - Handle Ballpoint Set (8 Pcs, mm)

KOD CODE	İÇERİK CONTENTS	g		TL/Ad.
4921 00 8108	2.5 - 3 - 4 5 - 6 - 7 - 8 - 10	755	8	2.929,00





**1000V İzoleli T Tipi Allen Anahtar (mm)**  
Hex Key Wrench T - Handle Insulated 1000V

**YENİ  
NEW**

± 1000 V  
IEC 60900

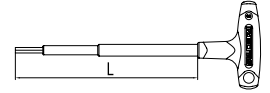

**Krom vanadyum, iki komponent saplı**  
Chrome vanadium, Two component handle

KOD CODE	mm	L mm	g	TL/Ad.
13000 005610	2.5	88	15	5 218,50
13000 005611	3	102	20	5 222,00
13000 005612	4	110	30	5 249,75
13000 005613	5	125	55	5 266,50
13000 005614	6	140	85	5 303,75
13000 005615	7	150	110	5 319,25
13000 005616	8	154	150	5 374,50
13000 005617	10	180	230	5 582,00

**13000 008092**

**1000V İzoleli T Tipi Allen Anahtar Takımı (8 Parça)**  
Hex Key Wrench T - Handle Set Insulated 1000V (8 Pcs)

**YENİ  
NEW**



KOD CODE	İÇERİK CONTENTS	g	TL/Ad.
13000 008092	2.5 - 3 - 4 - 5 6 - 7 - 8 - 10	695	8 2.535,75

# KESKİLER VE ÇEKİÇLER

CHISELS AND HAMMERS

- Keskiiler  
Chisels
- Zimbalar  
Punches
- Çekiçler  
Hammers
- Balta ve Nacaklar  
Hatchets
- Keserler  
Adzes



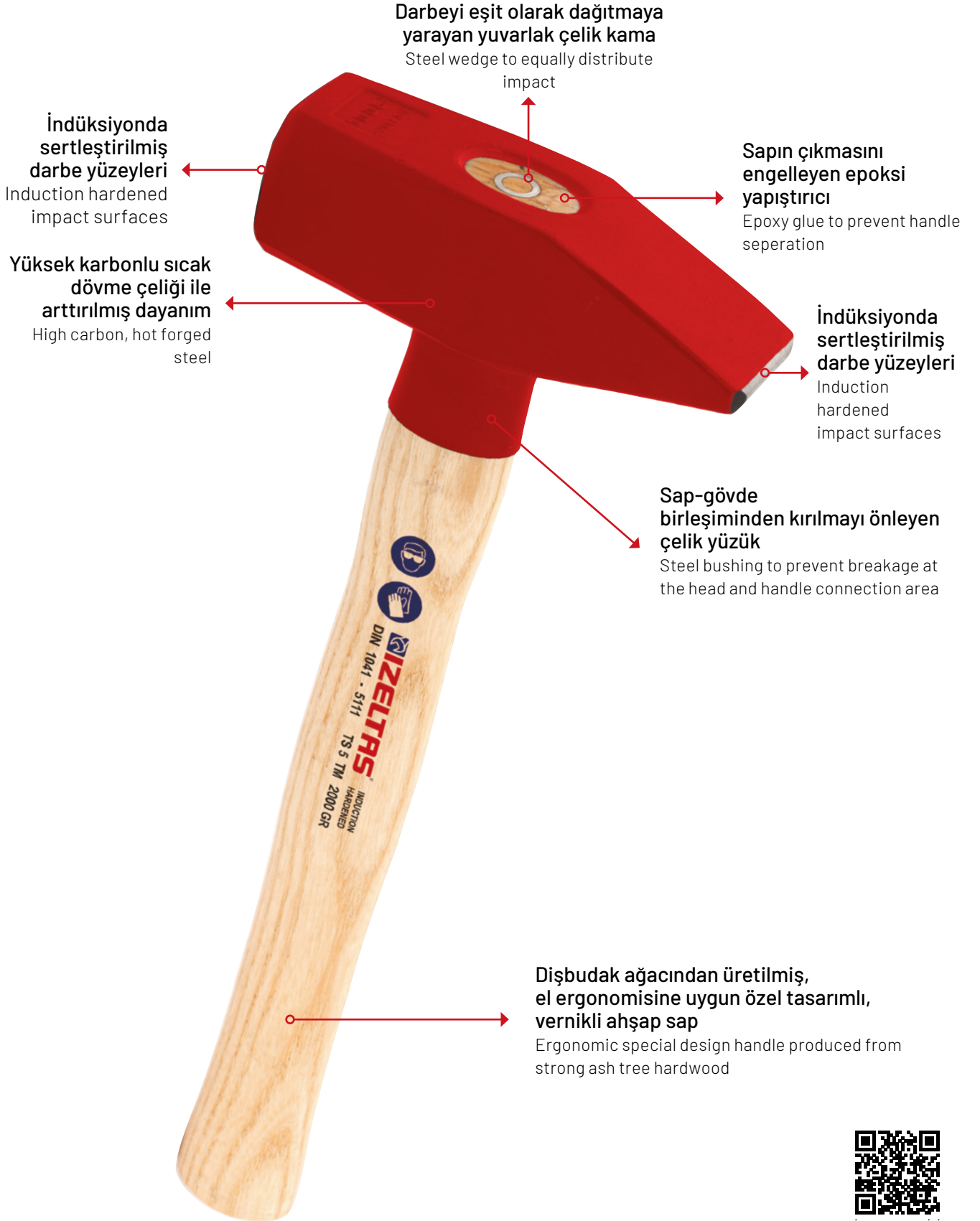



**5010**
**Iskarpela (Düz)**  
**Wood Chisel**

TS 531

**Özel alaşımli çelik, Uç indüksiyonda sertleştirilmiş, PP Saplı**  
**Special steel, Induction hardened tips, PP Handle**

KOD CODE	a mm	L mm	L1 mm	g	TL/Ad.	
5010 23 0006	6	240	120	115	5	366,00
5010 23 0008	8	242	122	125	5	390,00
5010 23 0010	10	244	124	135	5	411,75
5010 23 0012	12	246	126	135	5	452,50
5010 23 0014	14	248	128	145	5	467,00
5010 23 0016	16	250	130	150	5	500,50
5010 23 0018	18	252	132	160	5	542,50
5010 23 0020	20	254	134	170	5	602,50
5010 23 0022	22	256	136	190	5	653,00
5010 23 0024	24	258	138	195	5	705,75
5010 23 0026	26	260	140	200	5	731,00
5010 23 0030	30	264	144	205	5	780,00

**5010 00 8106**
**Iskarpela Düz Takım (6 parça)**  
**Wood Chisel Set (6 Pcs)**

KOD CODE	İÇERİK CONTENTS	g	TL/Ad.	
5010 00 8106	10 - 12 - 14 16 - 18 - 20	985	6	2.976,75

**5500**
**Düz Keski**  
**Flat Cold Chisel**

 TS 492  
 DIN 6453

**Özel alaşımli çelik, Krom kaplı**  
**Special steel, Chrom plated**

KOD CODE	L mm	a mm	g	TL/Ad.	
5500 23 0100	100	17	75	5	219,75
5500 23 0125	125	19	110	5	264,00
5500 23 0150	150	21	180	5	338,50
5500 23 0175	175	24	245	5	381,75
5500 23 0200	200	27	340	5	530,50
5500 23 0250	250	30	525	5	651,75
5500 23 0300	300	30	635	5	1.044,00

**5500**
**Düz Keski (Kalkan İzoleli)**  
**Flat Cold Chisel (With Safety Handle)**

 TS 492  
 DIN 6453

**Özel alaşımli çelik, Krom kaplı, PVC İzoleli**  
**Special steel, Chrom plated, PVC Handle**

KOD CODE	L mm	a mm	g	TL/Ad.	
5500 23 1250	250	30	700	1	829,25
5500 23 1300	300	30	790	1	1.208,50

**5510**
**Tesviyeci Düz Keski**  
 Flat Cold Chisel Octagonal

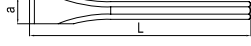
 TS 492  
 DIN 6453

**Krom vanadyum, Fosfat kaplı**  
 Chrom vanadium, Phosphate finish

KOD CODE	L mm	a mm	g	TL/Ad.
5510 23 0125	125	10	75	300,00
5510 23 0150	150	14	125	374,50

**5520**
**Tırnak Keski**  
 Cross Cut Chisel

**Krom vanadyum, Fosfat kaplı**  
 Chrom vanadium, Phosphate finish

KOD CODE	L mm	a mm	g	TL/Ad.
5520 23 0125	130	5	70	336,00
5520 23 0150	150	6	110	401,00

**5540**
**Nokta Zimba**  
 Center Punch

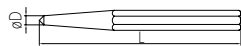
 TS 2338-3  
 DIN 7250

**Krom vanadyum, Fosfat kaplı**  
 Chrom vanadium, Phosphate finish

KOD CODE	L mm	L inch	σD mm	g	TL/Ad.
5540 24 4120	120	4 3/4"	4	65	253,25
5540 24 5120	120	4 3/4"	5	95	299,00
5540 24 5150	150	6"	5	115	330,00
★ 5540 24 0412	120	4 3/4"	4	65	251,00

★ Stoklarla Sınırlıdır / It is Limited by Stocks.

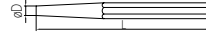
**5545**
**Konik Pim Zimba**  
 Drift Punch

 TS 2338-2  
 DIN 6458

**Krom vanadyum, Fosfat kaplı**  
 Chrom vanadium, Phosphate finish

KOD CODE	L mm	L inch	σD mm	g	TL/Ad.
5545 24 0002	120	4 3/4"	2	90	218,50
5545 24 0003	120	4 3/4"	3	90	237,75
5545 24 0004	120	4 3/4"	4	90	267,75
5545 24 0005	120	4 3/4"	5	95	272,50
5545 24 0006	120	4 3/4"	6	95	401,00
5545 24 0007	120	4 3/4"	7	100	417,75
5545 24 0008	150	6"	8	125	433,25
5545 24 0009	150	6"	9	130	444,00
5545 24 0010	150	6"	10	130	452,50
★ 5545 24 0012	150	6"	12	180	474,00
★ 5545 24 0103	120	4 3/4"	3	90	248,50

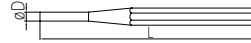
**5550**
**Düz Pim Zimba**  
 Split Pin Punch

 TS 2338-1  
 DIN 6450

**Krom vanadyum, Fosfat kaplı**  
 Chrom vanadium, Phosphate finish

KOD CODE	L mm	L inch	σD mm	g	TL/Ad.
5550 24 0002	150	6"	2	70	313,25
5550 24 0003	150	6"	3	65	313,25
5550 24 0004	150	6"	4	65	318,00
5550 24 0005	150	6"	5	65	318,00
5550 24 0006	150	6"	6	70	320,50
5550 24 0007	150	6"	7	100	333,75
5550 24 0008	150	6"	8	105	356,50
5550 24 0009	150	6"	9	110	362,50
5550 24 0010	150	6"	10	120	366,00
★ 5550 24 0105	150	6"	5	65	279,75

**5550 00 1006**
**Düz Pim Zimba Takımı (6 Parça)**  
 Split Pin Punch (6 Pcs)

KOD CODE	İÇERİK CONTENTS	g	TL/Ad.
5550 00 1006	3 - 4 - 5 - 6 - 7 - 8	865	1.960,00

## 5600 00 6106

### Keski Zimba Seti (6 Parça) Chisel And Punch Set (6 Pcs)



KOD CODE	İÇERİK CONTENTS	g	TL/Ad.
5510 23 0125	125 Tevsiyeci Düz Keski 125 Flat Cold Chisel Octagonal	865	1.819,50
5510 23 0150	150 Tevsiyeci Düz Keski 150 Flat Cold Chisel Octagonal		
5520 23 0125	130 Tırnak Keski 130 Cross Cut Chisel		
5540 24 4120	4x120 Nokta Zimba 4x120 Center Punch		
5550 24 0005	5x150 Düz Pim Zimba 5x150 Split PinPunch		
5545 24 0003	3x120 Konik Pim Zimba 3x120 Drift Punch		



## 5700

### Kayış Zimba Belt Punch

DIN 7200



Krom vanadyum, Elektrostatik boyanmış  
Chrom vanadium, Electrostatically painted

KOD CODE	ØD mm	L mm	g	TL/Ad.
5700 24 0003	3	105	35	187,25
5700 24 0004	4	105	40	195,75
5700 24 0005	5	110	50	212,50
5700 24 0006	6	110	60	217,25
5700 24 0007	7	115	75	239,00
5700 24 0008	8	115	90	253,25
5700 24 0009	9	120	100	283,25
5700 24 0010	10	120	110	301,25
5700 24 0011	11	125	130	324,00
5700 24 0012	12	125	165	387,75
5700 24 0013	13	130	165	408,00
5700 24 0014	14	130	180	447,75
5700 24 0015	15	135	245	512,50
5700 24 0016	16	135	300	561,75
5700 24 0017	17	140	365	614,50
5700 24 0018	18	140	380	669,75
5700 24 0019	19	145	405	728,50
5700 24 0020	20	145	450	775,25

## 5700

### Kayış Zimba Takımı Belt Punch Set



KOD CODE	İÇERİK CONTENTS	g	TL/Ad.
5700 00 2110	3 - 4 - 5 - 6 - 7 8 - 9 - 10 - 11 - 12	845	2.601,25
5700 00 2112	3 - 4 - 5 - 6 - 7 - 8 - 9 10 - 11 - 12 - 13 - 14	1180	3.457,00



5800

**Tesviyeci Çekiç**  
Machinist Hammer



TS 5-1  
DIN 1041



IZELTAS YOUTUBE

Yedek parça sayfa 255-259  
Spare parts page 255-259

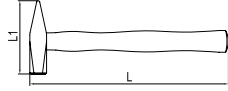

Özel alaşımlı çelik, İndüksiyonda sertleştirilmiş, Elektrostatik boyanmış  
Special steel, Induction hardened, Electrostatically painted

KOD CODE	L mm	L1 mm	g	g	TL/Ad.
5800 25 0100	260	82	100	160	10 405,75
5800 25 0200	280	95	200	260	10 443,00
5800 25 0300	300	105	300	395	10 536,50
5800 25 0500	320	118	500	600	5 620,50
5800 25 1000	360	135	1000	1095	5 896,50
5800 25 1500	380	145	1500	1630	5 1.176,00
5800 25 2000	400	155	2000	2100	5 1.446,00

5810

**Emniyet Çekiçi**  
Safety Hammer

TS 5-1



Özel alaşımlı çelik, İndüksiyonda sertleştirilmiş, Elektrostatik boyanmış  
Special steel, Induction hardened, Electrostatically painted

KOD CODE	L mm	L1 mm	g	g	TL/Ad.
5810 25 1000	360	135	1000	1095	5 1.167,75
5810 25 1500	380	145	1500	1630	5 1.615,25
5810 25 2000	400	155	2000	2100	5 1.994,50

**Emniyet çekiçi**

Çekiç kafası ile sapın birleşiminde yuvarlak kama ve yapışkan malzeme kullanılarak sağlamlığı artırılmış ayrıca birleşimi çelik sac malzeme ile desteklenerek güvenli kullanım sağlanmıştır.

**Safety Hammer**

Connection between the hammer head and the handle is ensured by circular wedge and epoxy glue, while it is also reinforced by sheet metal for safe use.

**Fiber Saplı Çekiç**  
Fiber Handle Hammer



TS 5-1  
DIN 1041

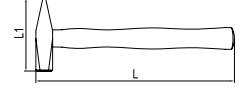

KOD CODE	L mm	L1 mm	g	TL/Ad.
14000 005215	320	118	500	1 1.206,50
14000 005216	360	135	1000	1 1.978,75
14000 005217	390	145	1500	1 2.645,50
14000 005218	400	155	2000	1 3.258,00

5850

**Plastik Çekiç**  
Plastic Hammer



TS 5-2

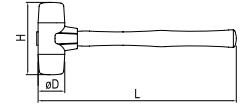

Yedek parça sayfa 255-259  
Spare parts page 255-259

Darbeye dayanıklı,  
Kolay değiştirilebilir başlık  
Durable and easily changeable heads

KOD CODE	L mm	σD mm	H mm	g	TL/Ad.
5850 25 0030	300	30	100	345	5 581,00
5850 25 0040	320	40	110	645	5 705,75
5850 25 0050	350	50	120	1015	5 895,25

5870 25 0400

**Lastik Çekiç**  
Rubber Hammer

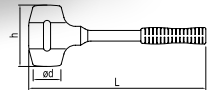

KOD CODE	L mm	σd mm	h mm	g	g	TL/Ad.
5870 25 0400	300	47	104	400	540	5 1.123,25

5865

Madırğa  
Mallet

TS 5-1

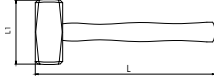

Yedek parça sayfa 255-259  
Spare parts page 255-259

Özel alaşımli çelik  
Special steel

KOD CODE	L mm	L1 mm				TL/Ad.
5865 25 1000	260	95	1000	1210	5	1.070,50
5865 25 1500	280	110	1500	1770	5	1.278,00

6410 25 0800

Nacak  
Hatchet

TS 748-4

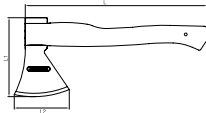

Yedek parça sayfa 255-259  
Spare parts page 255-259

Özel alaşımli çelik, İndüksiyonda sertleştirilmiş, Elektostatik boyanmış  
Special steel, Induction hardened, Electrostatically painted

KOD CODE	L mm	L1 mm	L2 mm				TL/Ad.
6410 25 0800	380	165	115	800	1065	1	2.136,00

13000 005248

Kamp Baltası  
Camping Hatchet

**YENİ**  
**NEW**

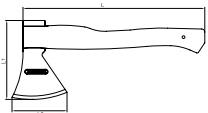

Özel alaşımli çelik, Elektostatik boyanmış  
Special steel, Electrostatically painted

KOD CODE	L mm	L1 mm	L2 mm			TL/Ad.
13000 005248	270	118	85	600	1	1.766,50

6400 25 0600

Keser  
Adze

TS 686-2

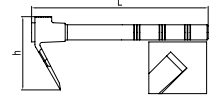

Yedek parça sayfa 255-259  
Spare parts page 255-259

Özel alaşımli çelik, İndüksiyonda sertleştirilmiş,  
Elektostatik boyanmış, PVC ağız koruyucu  
Special steel, Induction hardened, Electrostatically painted,  
PVC cutting edge protector

KOD CODE	L mm	h mm				TL/Ad.
6400 25 0600	400	125	400	550	5	1.179,75

6401 25 0600

Usta Keseri  
Master Adze

TS 686-2

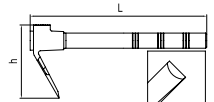

Yedek parça sayfa 255-259  
Spare parts page 255-259

Özel alaşımli çelik, İndüksiyonda sertleştirilmiş,  
Elektostatik boyanmış, PVC ağız koruyucu  
Special steel, Induction hardened, Electrostatically painted,  
PVC cutting edge protector

KOD CODE	L mm	h mm				TL/Ad.
6401 25 0600	400	125	400	540	5	1.179,75





IZELTAS  
DIN 5131 - 5232

INDUCTION  
HARDENED  
800 GR.

5410



IZELTAS



# GENEL EL ALETLERİ

## GENERAL HAND TOOLS

- Kablo Sıyırıcılar  
Cable Stripper
- Metreler  
Measuring Tapes
- Su Terazisi  
Straight Level
- Testereler  
Saws
- Servis Aletleri  
Service Equipment
- Gres Pompası ve Yağdanlık  
Grease Gun and Oilers
- Yağ Filtre Sökecekleri  
Oil Filter Wrench
- Tel Fırçalar  
Hand Brushes
- Uzatma Kabloları  
Extension Cords
- Multi Tool  
Multi Tool
- Mengeneler  
Forged Steel Vice
- İşkenceler  
Clamps
- Tamirci Kızakları  
Mechanics Creeper
- Spreyler  
Spreys



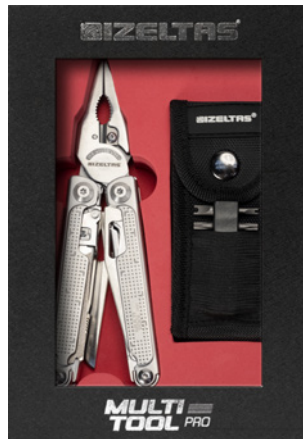
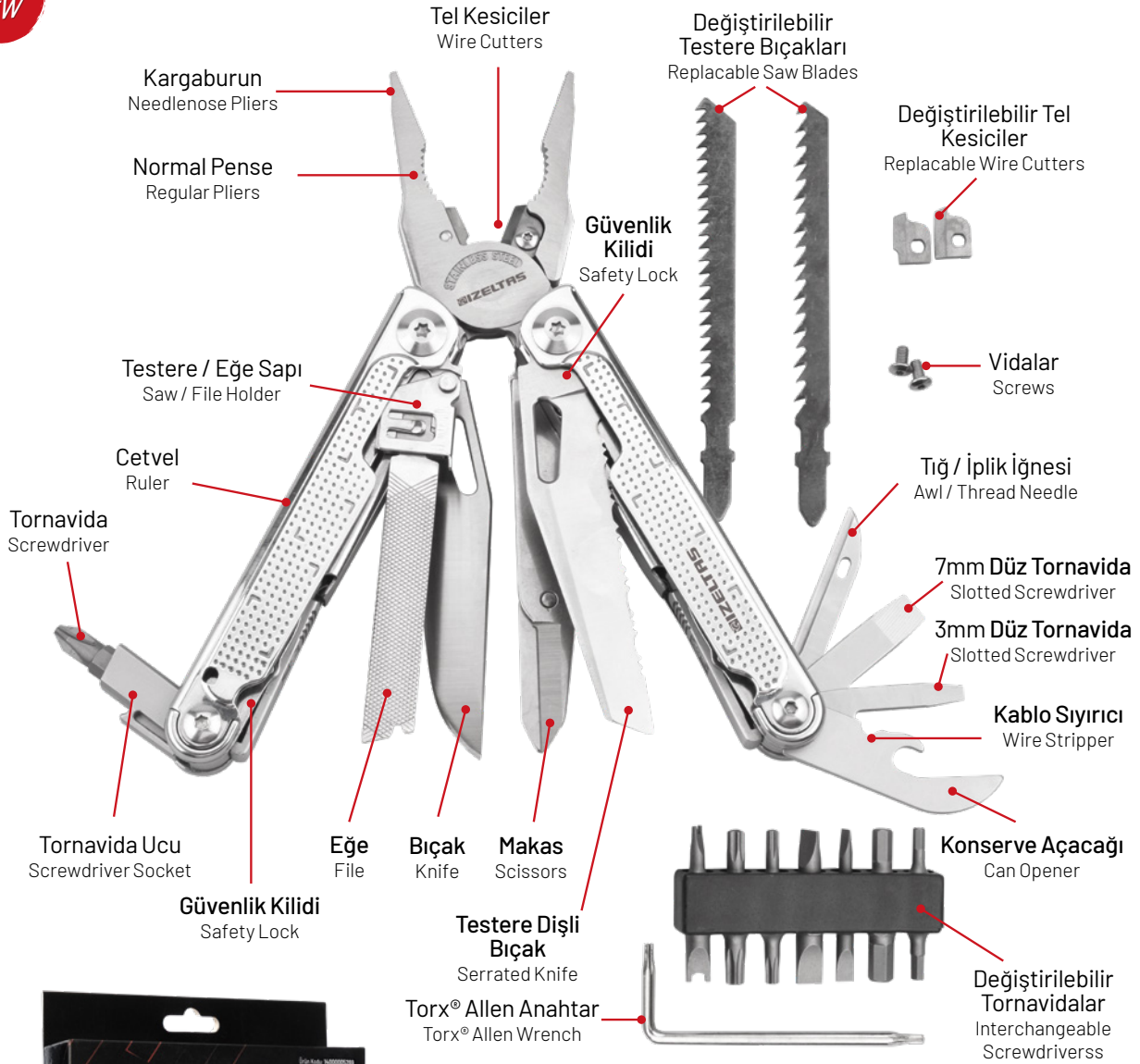

KOD CODE	L mm	g	TL/Ad.
14000 005269	180	720	3.761,25

14000 005270

155 mm Multi Tool Pro (15 Fonksiyonlu)

155 mm Multi Tool Pro (15 Functions)

**MULTI  
TOOL**

**YENİ  
NEW**

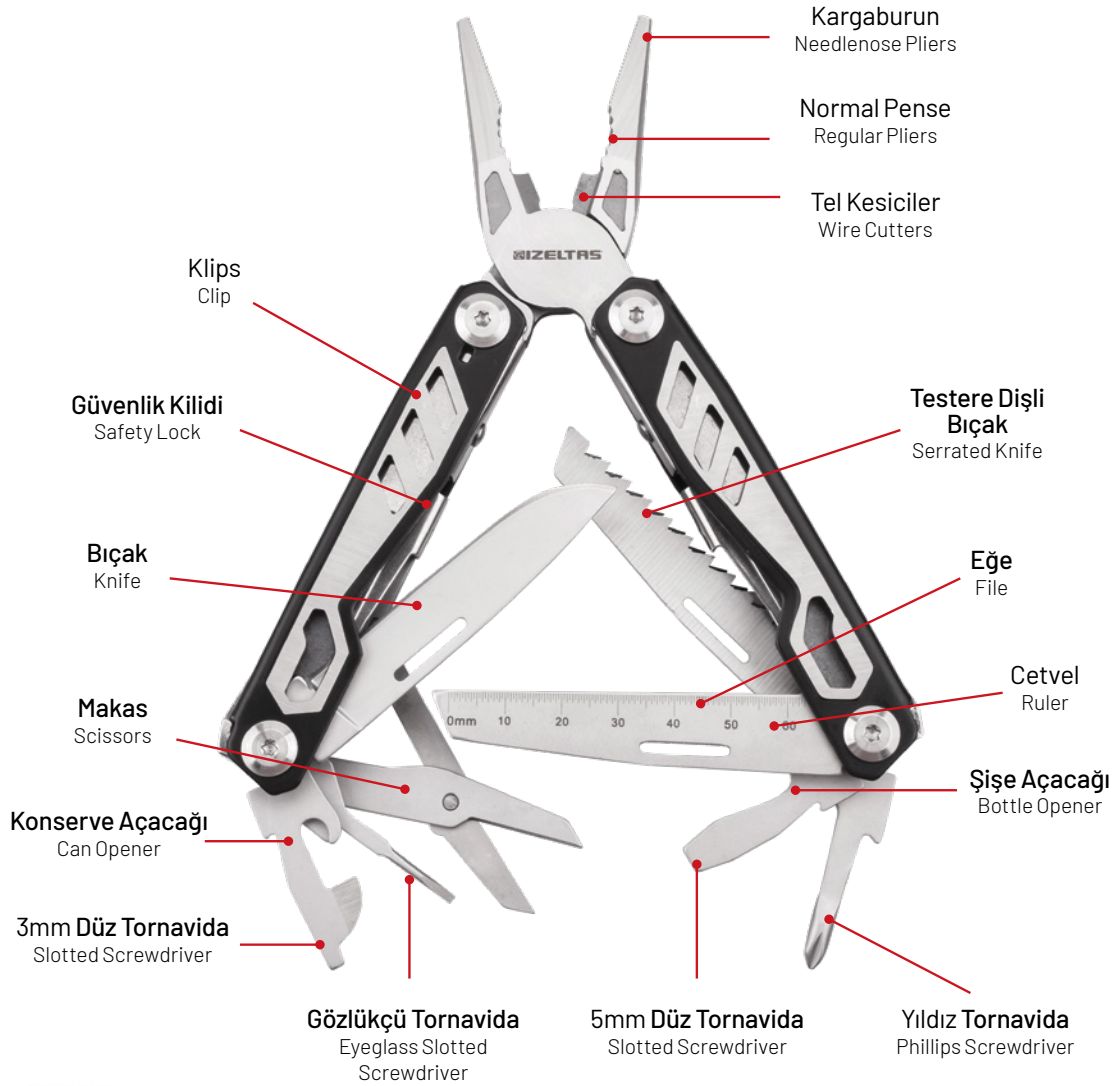

KOD CODE	L mm	g	1	TL/Ad.
14000 005270	155	540	1	1.639,25

Özel hediye kutusuyla satılır / Sold with a special gift box



Tüm standart kabloları sıyırmak için daha uzun ömür, daha hızlı kesme ve daha az aşınma sağlayan özel titanyum nitrür (TIN) kaplama  
Tin plated long lasting/fast cutting blade to strip all standard cables

Özel alışımlı çelikten sertleştirilmiş ve kaplanmış kanca bıçak  
Plated special alloy hardened steel hook blade

Kapasite 8-28mm çaplı kablolar için uygun  
Suitable for 8-28mm diameter cables

Özel kaydırmaz formu dayanıklı polyamid (PA) sap  
Non-slip and durable polyamid handle

Çevirerek kolay bıçak yükseklik ayarı  
Easy-to-rotate blade height adjuster

03750 50 020

**Kablo Sıyrıcı (Kanca Bıçaklı)**  
Cable Stripper (With Hooked Blade)



 Yedek parça sayfa 255-259  
Spare parts page 255-259

KOD CODE	ÖLÇÜ SIZE	g	□	TL/ Ad.
03750 50 020	Ø8-28	79	5	811,25

03752 50 625

**Kablo Sıyrıcı**  
Cable Stripper



 Yedek parça sayfa 255-259  
Spare parts page 255-259



İZELTAS YOUTUBE

KOD CODE	ÖLÇÜ SIZE	g	□	TL/ Ad.
03752 50 625	Ø4-16	70	5	739,25

03751 50 012

**Koaksiyel Kablo Sıyrıcı**  
Coaxial Cable Stripper



İZELTAS YOUTUBE

KOD CODE	ÖLÇÜ SIZE	g	□	TL/ Ad.
03751 50 012	A Dış (1) B İç (2)	20	5	1.052,50

03753 50 054

**Mekanik Kablo Sıyrıcı**  
Mechanical Cable Stripper



KOD CODE	ÖLÇÜ SIZE	g	□	TL/ Ad.
03753 50 054	0.2/6	100	5	1.387,25

03753 50 026

**Elektro Mekanik Kablo Sıyrıcı**  
Mechanical Cable Stripper

**YENİ**  
**NEW**



KOD CODE	ÖLÇÜ SIZE	g	□	TL/ Ad.
03753 50 026	0.2/6	105	5	1.731,75

**05881**
**Plastik Şerit Metre (3m - 5 m)**  
 Plastic Steel Case, Measuring Tapes

KOD CODE	ÖLÇÜ SIZE M	g		TL/Ad.
0588150 003	3	145	5	329,00
0588150 005	5	200	5	395,00

**05881**
**Krom Şerit Metre (3m - 5 m)**  
 Chrom Steel Case, Measuring Tapes

KOD CODE	ÖLÇÜ SIZE M	g		TL/Ad.
05881 50 013	3	160	5	391,25
05881 50 015	5	220	5	441,75

**14000 005371**
**Krom Şerit Metre (8 m)**  
 Chrom Steel Case, Measuring Tapes

**YENİ NEW**

Şeridin her iki yüzeyi de ölçü skalalıdır / Both sides of the tape has measurements

KOD CODE	ÖLÇÜ SIZE M	g		TL/Ad.
14000 005371	8	410	5	697,50

**05886**
**Arazi Tipi Fiberglas Şerit Metre (Saplı)**  
 Fiberglass Measuring Tape Field Type (With Holder)

KOD CODE	ÖLÇÜ SIZE M	g		TL/Ad.
05886 50 020	20	520	1	791,00
05886 50 030	30	585	1	845,00
05886 50 050	50	820	1	1.357,25

**05887 50 150**
**Kumpas Vernier**

**Sürgülü, Stoplu**  
 Sliding and with stop

KOD CODE	L mm	g		TL/Ad.
05887 50 150	150	155	5	2.847,75

**05880**
**Su Terazisi**  
 Straight Level

**Alüminyum gövde**  
 Aluminyum body

KOD CODE	L mm	g		TL/Ad.
05880 50 040	400	250	5	1.181,00
05880 50 050	500	300	5	1.279,25
05880 50 060	600	350	5	1.391,00
05880 50 070	700	400	5	1.494,00
05880 50 080	800	450	5	1.614,00
05880 50 100	1000	500	5	1.837,25
05880 50 120	1200	550	5	2.173,25
05880 50 150	1500	600	5	2.504,50
05880 50 200	2000	800	5	3.498,00



05901 50 020

Sentil (20 Parça, mm)  
Feeler Gauges (20 Pcs, mm)



KOD CODE	ÖLÇÜ SIZE mm	g		TL/ Ad.
05901 50 020	0.05 - 1	90	10	261,75

05902 50 020

Sentil (20 Parça, SAE)  
Feeler Gauges (20 Pcs, SAE)



KOD CODE	ÖLÇÜ SIZE inch	g		TL/ Ad.
05902 50 020	2 - 35/1000"	65	10	408,00

6735 27 0300

Dal Budama Testeresi  
Pruning Saw



 Yedek parça sayfa 255-259  
Spare parts page 255-259

KOD CODE	L mm	g		TL/Ad.
6735 27 0300	300	400	5	1.236,00

14000 004238

Katlanabilir Budama Testeresi  
Foldable Pruning Saw



**YENİ**  
**NEW**

KOD CODE	L mm	g		TL/ Ad.
14000 004238	120	155	5	1.034,50

05890 50 830

Testere Kolu  
Hacksaw Frame



 Yedek parça sayfa 255-259  
Spare parts page 255-259

KOD CODE	L mm	g		TL/ Ad.
05890 50 830	300	540	5	1.233,75

6195 26 0260

Perçin Tabancası  
Riveting Pliers



2.4 - 2.5 - 3 - 4 - 4.8 Pop perçin kullanımına uygundur.  
It is suitable for use with 2.4 - 2.5 - 3 - 4 - 4.8 pop rivets.

KOD CODE	ÖLÇÜ SIZE	CAPACITY mm	g		TL/Ad.
6195 26 0260	260	2 - 2.5 - 3 - 3.2	625	1	1.302,00

6220

Spiralli Mıknatıs  
Flexible Magnet Holder



KOD CODE	KAPASİTE g	L mm	L1 mm	g		TL/ Ad.
6220 26 0500	500	465	375	100	10	819,75
6220 26 1000	1000	465	375	105	10	867,75

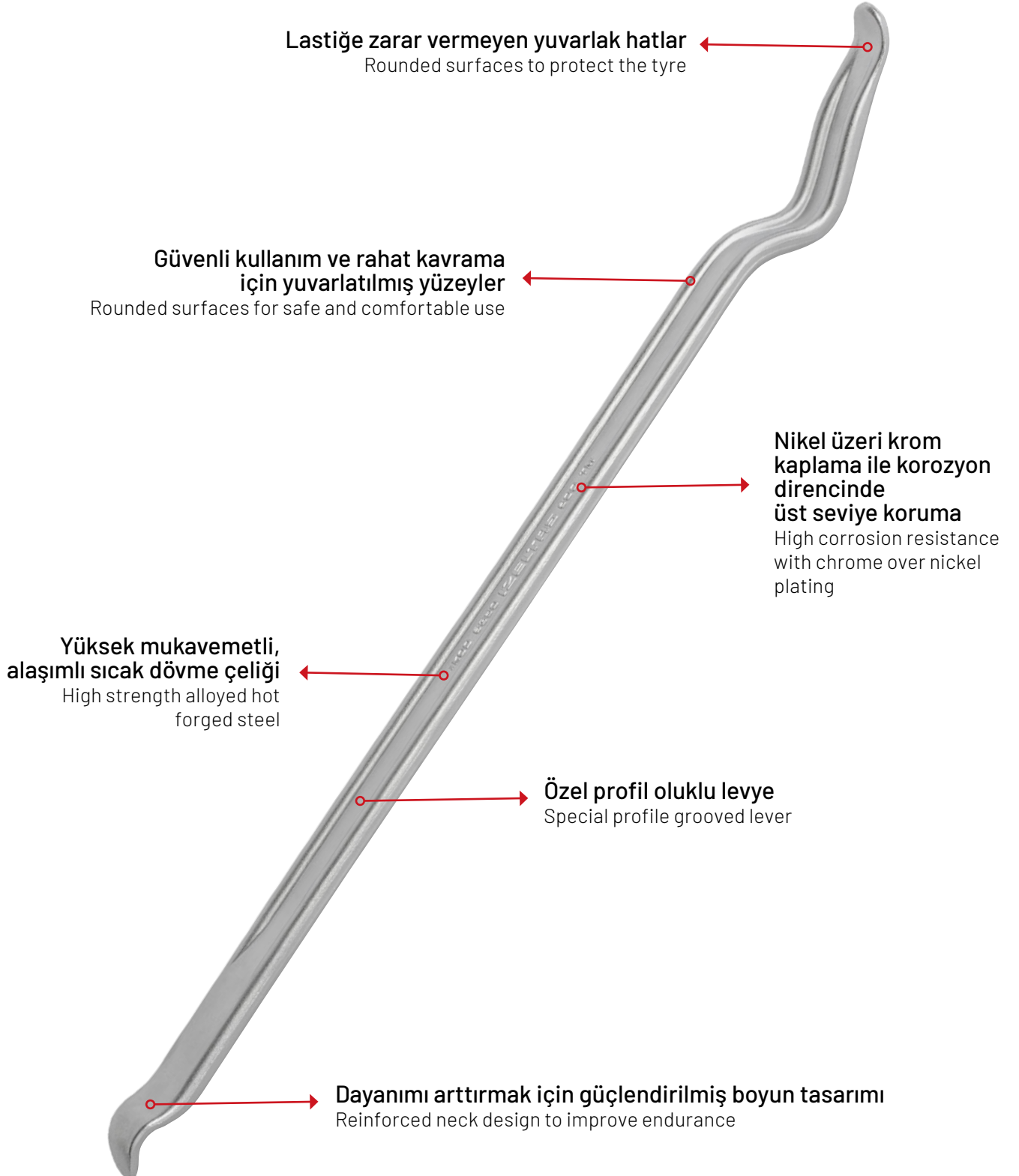

**6230**
**Gres Pompası**  
Grease Gun

 **Yedek parça sayfa 255-259**  
Spare parts page 255-259

KOD CODE	ÖLÇÜ SIZE cc	g		TL/Ad.
6230 26 0300	300	1200	1	1.055,00
6230 26 0500	500	1320	1	1.298,50

**6240 26 0810**
**Tapa Anahtarı (iki ağız)**  
Offset Wrench For Carter Case

**Krom vanadyum, Krom kaplı**  
Chrom vanadium, Chrom plated

KOD CODE	ÖLÇÜ mm	g		TL/Ad.
6240 26 0810	8x10	250	10	413,00

**6350**
**Levye Oluklu**  
Tyre Lever, Straight

**TSEK**

**Krom vanadyum, Krom kaplı**  
Chrom vanadium, Chrom plated

KOD CODE	L mm	L inch	g		TL/Ad.
6350 26 0300	300	12"	265	5	391,25
6350 26 0400	400	16"	440	5	493,25
6350 26 0500	500	20"	675	5	685,25
6350 26 0600	600	24"	900	5	837,75

**6225**
**Madeni Yağdanlık (Flexible Uçlu)**  
Oiler With Flexible Spout

KOD CODE	ÖLÇÜ SIZE cc	g		TL/Ad.
6225 26 0200	200	170	5	435,75
6225 26 0300	300	200	5	489,75
6225 26 0500	500	225	5	537,75

**6360 26 0600**
**Levye Oluklu Kıvrık Uçlu**  
Tyre Lever, Bent

**TSEK**

**Krom vanadyum, Krom kaplı**  
Chrom vanadium, Chrom plated

KOD CODE	L mm	L inch	g		TL/Ad.
6360 26 0600	600	24"	910	5	925,25

**14000 005358**
**Topuklu Keçe Levye**  
Prybar

**YENİ NEW**

KOD CODE	L mm	g		TL/Ad.
14000 005358	400	460	5	1.025,00



**6375 26 6512****Çift Yönlü Üç Ayaklı Yağ Filtresi Sökeceği**  
Left and Right Hand Operation, Triple Leg Oil Filter Wrench**3/8" - 1/2"**

KOD CODE	Ø mm	g	□	TL/Ad.
6375 26 6512	75-120	605	5	2.136,00

**06374 50 140****Zincirli Yağ Filtresi Sökeceği**  
Chain Wrench

KOD CODE	Ø mm	g	□	TL/Ad.
06374 50 140	60x140	390	5	1.290,00

**6380 26 6016****Çift Zincirli Yağ Filtresi Sökeceği**  
Oil Filter Wrench With Double Chain

KOD CODE	Ø mm	g	□	TL/Ad.
6380 26 6016	60-160	380	5	5.781,75

**6370 26 0100****Yağ Filtresi Sökeceği**  
Band Type Oil Filter Wrench

KOD CODE	Ø mm	g	□	TL/Ad.
6370 26 0100	75 - 100	335	5	611,00

**06373 50 140****Kayıslı Yağ Filtresi Sökeceği**  
Strap Wrench

KOD CODE	Ø mm	g	□	TL/Ad.
06373 50 140	60x140	245	5	1.496,50

**06375 50 100****Ayarlı Yağ Filtresi Sökeceği**  
Adjustable Slot Type Oil Filter Wrench **Yedek parça sayfa 255-259**  
*Spare parts page 255-259*

KOD CODE	Ø mm	g	□	TL/Ad.
06375 50 100	65-110	215	5	715,25

06390

**Segman Çemberi**  
Piston Ring Compressor



KOD CODE	Ø mm	g	TL/Ad.
06390 50 125	125	235	5 1.275,75
06390 50 175	175	505	5 2.435,00

07415

**Sıralı Tel Fırça (Ağaç Saplı)**  
Hand Brush (Wooden Handle)



KOD CODE	ÖLÇÜ SIZE	g	TL/Ad.
07415 50 003	3 SIRA 3 RAWS	125	5 95,00
07415 50 004	4 SIRA 4 RAWS	135	5 101,00
07415 50 005	5 SIRA 5 RAWS	145	5 113,00
07415 50 006	6 SIRA 6 RAWS	170	5 120,00

07416 50 001

**Kıvrık Uçlu Fırça (Plastik Saplı)**  
Hand Brush (PP Handle)



KOD CODE	L mm	g	TL/Ad.
07416 50 001	250	110	5 149,00

07410 50 010

**Makaralı Uzatma Kablosu (El Tipi)**  
Extension Cord Reel (With Handle)

YENİ TASARIM  
NEW DESIGN



**TEKNİK ÖZELLİKLER / TECHNICAL DATA**

Nominal Gerilim / Nominal Voltage	230V- 50/60Hz
Akım / Current	Max. 16A
Kablo Sarılı Halde Maks. Güç / Load Reeled	1000W
Kablo Açılmış Halde Maks. Güç / Extended Max.	3680W
Soket Tipi / Socket Type	4x2 P + E
Soket Standardı /Socket Standart	Schuko (F-type)
Kablo / Cable	Max. ø 3x2.5mm
Giriş Koruması / Ingress Protection	IP44-IP20

KOD CODE	MODEL	ÖLÇÜ SIZE	g	TL/Ad.
07410 50 010	el tipi / with handle	10	1400	1 2.951,00

07410

**Makaralı Uzatma Kablosu (Ayaklı)**  
Extension Cord Reel (With Stand)

YENİ TASARIM  
NEW DESIGN



**TEKNİK ÖZELLİKLER / TECHNICAL DATA**



Nominal Gerilim / Nominal Voltage	230V- 50/60Hz
Akım / Current	Max. 16A
Kablo Sarılı Halde Maks. Güç / Load Reeled	1000W
Kablo Açılmış Halde Maks. Güç / Extended Max.	3680W
Soket Tipi / Socket Type	4x2 P + E
Soket Standardı /Socket Standart	Schuko (F-type)
Kablo / Cable	Max. ø 3x2.5mm
Giriş Koruması / Ingress Protection	IP44-IP20

KOD CODE	MODEL	ÖLÇÜ SIZE	g	TL/Ad.
07410 50 025	ayaklı / with stand	25	4130	1 5.214,00
07410 50 050	ayaklı / with stand	50	6745	1 10.411,25



- ✓ Çok amaçlı kullanım
  - Multipurpose usage
- ✓ Paslanmış civata-somun bağlantılarını gevşetir
  - Loosens rust
- ✓ Hassas mekanizmaları yağlar
  - Eliminates squeaky noises
- ✓ Nemi bertaraf eder
  - Removes humidity
- ✓ Metalleri paslanmaya karşı korur
  - Protects and preserves tools
- ✓ Mükemmel temizlik yapar
  - Cleans metal surfaces



KOD/CODE	 ml		TL/Ad.
14000 004446	400	12	365,00



14000 005274

Fren ve Balata Temizleyici 500ml  
Brake Cleaner 500ml





14000 005275



Sıvı Gres 400ml  
Liquid Grease 400ml



- ✓ Frenler (tambur ve disk frenler, fren balataları, fren pabuçları, silindirler, yaylar ve burçlar)
  - On brakes (drum and disk brakes, linings, brake pads, cylinders, springs and bushes)
- ✓ Debriyajlar (debriyaj balataları ve parçaları)
  - On clutches (clutch linings and components)
- ✓ Motor parçaları (karbüratörler, benzin ve yağ pompaları, şanzımanlar vs.)
  - On engine components (carburettors, fuel and oil pumps, transmissions etc.)

- ✓ Güç aktaran parçalar
  - For long-lasting lubrication of power-transmitting bolts and pins
- ✓ Dişliler ve dişli çarklar
  - toothed wheels and wormgear
- ✓ Hızlı hareket eden makine parçaları
  - fast-moving engine parts
- ✓ Hareketli parçalar ve şanzımanlar
  - joints and clutches
- ✓ Tekerlekler ve bilyeli yataklar
  - roller and ball bearings
- ✓ Yay paketleri
  - spring packs

KOD/CODE	 ml		TL/Ad.
14000 005274	500	12	187,25

KOD/CODE	 ml		TL/Ad.
14000 005275	400	12	349,25

**DÖVME ÇELİK MENGENE / FORGED STEEL VICE WITH SWIVEL BASE**

Isıl işlem sonrasında ilave olarak yapılan  
indüksiyonda sertleştirme işlemi ile güçlü tutuş  
sağlayan özel profilli çeneler

Heat treated and induction hardened special profile jaws  
for powerful grip

İndüksiyonda  
sertleştirilmiş darbeye  
dayanıklı yüzeyler

Induction hardened impact  
resistant surfaces

Yüksek  
karbonlu sıcak dövme  
çeliği ile artırılmış  
dayanım

Improved lifetime with hot  
forged high carbon steel

Elektrostatik fırın  
boya ile korozyon  
direnci sağlanmış  
yüzeyler

High corrosion  
resistance with  
electrostatic powder  
paint

İndüksiyonda  
sertleştirme ile  
kullanım ömrü  
arttırılmış, korozyona  
karşı çinko ile  
kaplanmış ilerleme mili

High strength alloyed steel.  
High corrosion protection  
with chrome over nickel  
plating

Yüksek mukavemetli,  
alaşımli çelik  
Nikel üzerine krom  
kaplama ile sağlanan,  
korozyon direncinde üst  
seviye koruma

High strength alloyed steel.  
High corrosion protection  
with chrome over nickel  
plating

Çevirme kolunun  
yerinden çıkmaması için  
kullanılan kauçuklar

Rubber stoppers to keep  
the bar on the spindle

Çelik döküm  
mengene altlığı

Cast steel base plate

Mengenenin 360°  
dönmesini sağlayan  
çelik döner parça

Vice plate for 360° rotation

7401

**Mengene Döner Tablası**  
Swivel Base of Vice

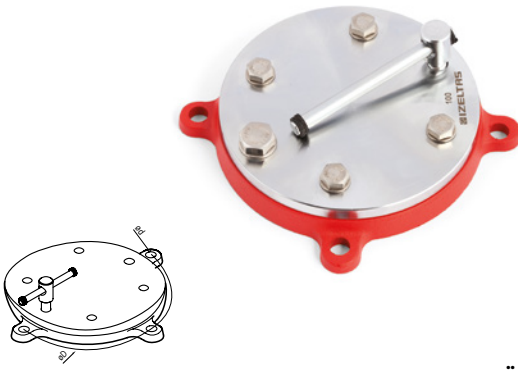

Özel alaşım çelik  
Special steel

KOD CODE	ÖLÇÜ SIZE	σd mm	σD mm	g	□	TL/Ad.
7401 30 0100	100	10.5	160	1550	1	1.971,75
7401 30 0125	125	12.5	200	2700	1	2.604,00
7401 30 0150	150	12.5	240	3800	1	3.161,00
7401 30 0175	175	12.5	280	6650	1	3.573,75

7400

**Dövme Çelik Mengene**  
Forged Steel Vice

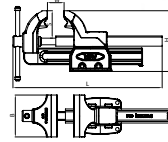

Özel alaşım çelik, Fırın boya  
Special steel, Electrostatic Paint

KOD CODE	B mm	W mm	H mm	L mm	g	□	TL/Ad.
7400 30 0100	100	125	148	440	5000	1	7.424,50
7400 30 0125	125	155	183	550	11000	1	10.080,00
7400 30 0150	150	180	220	675	20000	1	14.457,75
7400 30 0175	175	205	245	760	29000	1	19.537,25

7400

**Dövme Çelik Mengene (Döner Tabla dahil)**  
Forged Steel Vice with Swivel Base

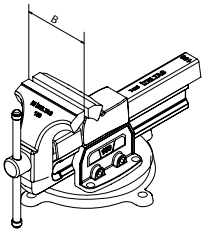

KOD CODE	B mm	g	□	TL/Ad.
7400 00 0100	100	6550	1	9.396,25
7400 00 0125	125	13700	1	12.684,00
7400 00 0150	150	23800	1	17.618,75
7400 00 0175	175	35650	1	23.111,00



## Tesviyeci Mengenesi Machinist Forged Steel Vise

YENİ  
NEW

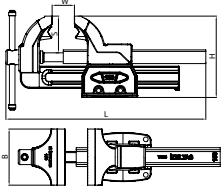

Özel alaşım çelik, Fırın boya  
Special steel, Electrostatic Paint

KOD CODE	B mm	W mm	H mm	L mm	g	TL/Ad.
14000 005070	100	125	120	308	5200	6.098,00
14000 005069	125	160	140	388	9300	8.212,50
14000 005072	150	190	190	480	18500	13.145,00
14000 005071	175	205	200	520	25000	15.726,00

## Tesviyeci Mengene Döner Tabla Swivel Base Of Machinist Vise

YENİ  
NEW

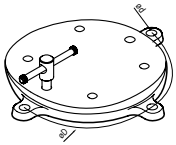

Özel alaşım çelik, Fırın boya  
Special steel, Electrostatic Paint

KOD CODE	ÖLÇÜ SIZE	d mm	D mm	g	TL/Ad.
14000 005126	100	11.5	150	800	1.398,75
14000 005127	125	13.5	185	1300	1.744,25
14000 005128	150	16	225	2000	2.208,75
14000 005129	175	17.5	250	2600	2.423,25

**7300**
**İşkence (Marangoz Mengenesi Plastik Ağızlı)**  
 Carpenter Screw Clamp

**Darbeye dayanıklı çeneler**  
 Impact resistant cast iron jaws

KOD CODE		a mm	b mm			TL/Ad.
7300 30 3012	30x12	300	120	1605	5	1.556,50
7300 30 4012	40x12	400	120	1780	5	1.839,75
7300 30 5012	50x12	500	120	1935	5	1.885,25
7300 30 6012	60x12	600	120	2080	5	1.968,00
7300 30 8012	80x12	800	120	2470	5	2.087,00
7300 30 1012	100x12	1000	120	2790	5	2.381,00

**7310**
**Mini İşkence**  
 Mini Clamp

**Alaşımlı alüminyum çeneler**  
 Alloyed aluminum jaws

KOD CODE		a mm	b mm			TL/Ad.
7310 30 1005	10x5	100	50	250	5	671,00
7310 30 1505	15x5	150	50	280	5	705,75
7310 30 2005	20x5	200	50	310	5	732,00
7310 30 2505	25x5	250	50	330	5	763,25
7310 30 3005	30x5	300	50	360	5	791,00

**14000 004293**
**Tekerli Tamirci Kızağı (Büyük) 40"**  
 Mechanics Creeper (Big) 40"

KOD/CODE	Ölçü / SIZE (mm)	Düşük Profil / Low Profile		TL/Ad.
14000 004293	500x1010	65 mm	1	2.952,00

**14000 004294**
**Tekerli Tamirci Kızağı (Küçük) 36"**  
 Mechanics Creeper (Small) 36"

KOD/CODE	Ölçü / SIZE (mm)	Düşük Profil / Low Profile		TL/Ad.
14000 004294	400x900	65 mm	1	2.137,25

# YENİ FENERLERLE YOLUMUZ HEP AÇIK



**1** | 1000 LM Led El Feneri  
1000 LM Led Flashlight  
Ürün Kodu / Code: 14000 005346

**2** | 1000 LM Pro Led El Feneri  
1000 LM Pro Led Flashlight  
Ürün Kodu / Code: 14000 005345

**3** | 400 LM Led Kafa Feneri Hareket Sensörlü  
400 LM Led Headlamp with Sensor  
Ürün Kodu / Code: 14000 005347

**4** | 450 LM Cob Led Kafa Feneri  
400 LM Led Headlamp  
Ürün Kodu / Code: 14000 005344



**IZELTAS®**

# AYDINLATMA

LIGHTING

- Çalışma Lambası  
Work Light
- Fener  
Torch Light

- Kafa Lambası  
Head Lamp



**1000 LM Led El Feneri**  
**1000 LM Led Flashlight**

**TEKNİK ÖZELLİKLER / TECHNICAL DATA**

LED Samsung					
1. Mod / Mode	Yüksek High	Orta Middle	Düşük Low	Gizli Atar Işık Hidden Strobe	SOS
Işık Gücü / Output (Lümen / Lumen)	1000	500	80	-	-
Çalışma Süresi / Battery Life (Saat / Hour)	3	3,5	10	-	-

LED Samsung			
2. Mod / Mode	Yüksek High	Orta Middle	
Işık Gücü / Output (Lümen / Lumen)	250	35	
Çalışma Süresi / Battery Life (Saat / Hour)	4,5	17	

❗ Şarj adaptörü dahil değildir / Charger not included

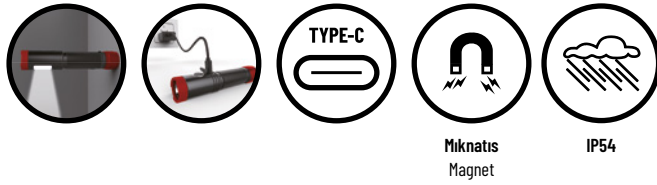

KOD / CODE	Pil / Battery	Şarj Süresi (Saat) Charging Time (Hour)	g	L mm		TL/Ad.
14000 005346	2600 mAh Li-Ion 18650	4-5	118	124	1	2.132,25

**14000 005345**
**1000 LM Pro Led El Feneri**  
**1000 LM Pro Led Flashlight**

**TEKNİK ÖZELLİKLER / TECHNICAL DATA**

LED Samsung   395 nm UV   Kırmızı Lazer - Red Laser					
Mod / Mode	Yüksek High	Orta Middle	Düşük Low	Gizli UV Hidden UV	Kırmızı Lazer + Yüksek Red Laser + High
Işık Gücü / Output (Lümen / Lumen)	1000	500	200	-	-
Çalışma Süresi / Battery Life (Saat / Hour)	2	2,5	12	-	-

❗ Şarj adaptörü dahil değildir / Charger not included

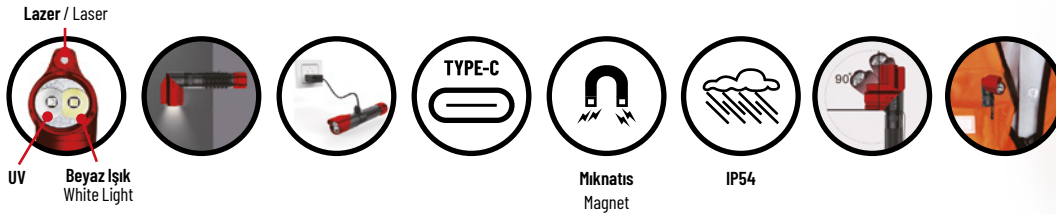
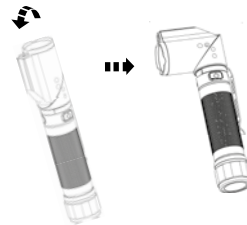

KOD / CODE	Pil / Battery	Şarj Süresi (Saat) Charging Time (Hour)	g	L mm		TL/Ad.
14000 005345	2600 mAh Li-Ion 18650	3-4	209,2	158	1	3.012,25

14000 005347

400 LM Led Kafa Feneri Hareket Sensörlü  
400 LM Led Headlamp with Sensor

YENİ  
NEW



TEKNİK ÖZELLİKLER / TECHNICAL DATA

LED	Samsung   Lumiled		
Mod / Mode	Nokta Spot	Işıldak Flood	Hepsi Açık All-OPn
Işık Gücü / Output (Lümen / Lumen)	200	100	400
Çalışma Süresi / Battery Life (Saat / Hour)	9	17	4

⚠ Şarj adaptörü dahil değildir / Charger not included  
Pil değiştirilebilir değildir / Battery is non-replacable

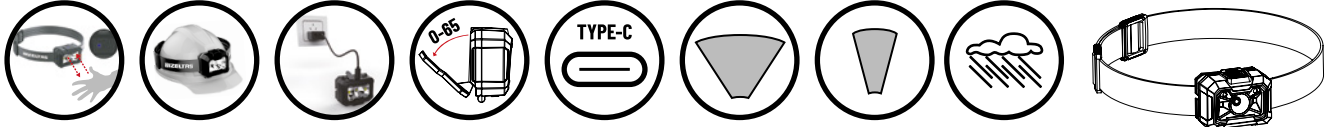

Algılayıcı Aç/Kapat  
Sensor On/Off

Geniş  
Wide

Dar  
Spot

IP65

KOD / CODE	Pil / Battery	Şarj Süresi (Saat) Charging Time (Hour)	g	L mm	TL/Ad.
14000 005347	1500 mAh LiPo	2-3	90.4	61	1.171,25

14000 005344

450 LM Cob Led Kafa Feneri  
400 LM Led Headlamp

YENİ  
NEW



TEKNİK ÖZELLİKLER / TECHNICAL DATA

LED	COB LED		
Mod / Mode	Yüksek High	Orta Middle	Düşük Low
Işık Gücü / Output (Lümen / Lumen)	450	140	25
Çalışma Süresi / Battery Life (Saat / Hour)	1,5	3	13

⚠ Şarj adaptörü dahil değildir / Charger not included

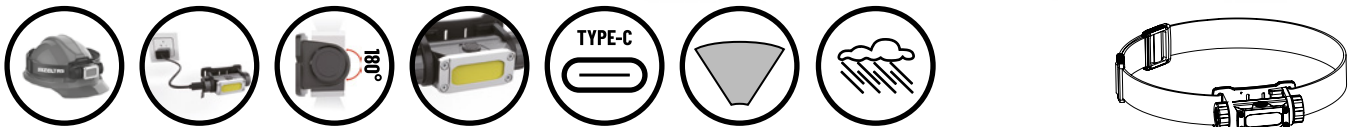

Alüminyum Çerçeve  
Aluminum Frame

Geniş  
Wide

IP65

KOD / CODE	Pil / Battery	Şarj Süresi (Saat) Charging Time (Hour)	g	L mm	TL/Ad.
14000 005344	880 mAh Li-Ion 14500	2-3	83	65	1.963,50



14000 005383

600 LM Cob Led Çalışma Lambası  
600 LM Cob Led Work Light

YENİ  
NEW



TEKNİK ÖZELLİKLER / TECHNICAL DATA

Mod / Mode	Yüksek High	Orta Middle	Üst Işık Top Light
Işık Gücü / Output (Lümen / Lumen)	600	200	200
Çalışma Süresi / Battery Life (Saat / Hour)	3	12	9

⚠ Şarj adaptörü dahil değildir / Charger not included

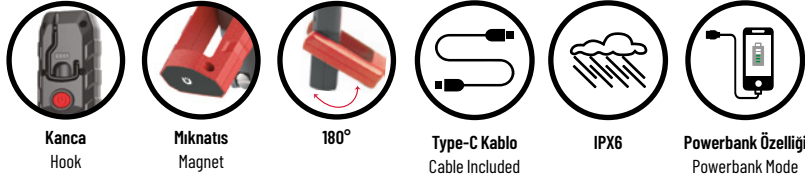

Kanca  
Hook

Mıknatıs  
Magnet

180°

Type-C Kablo  
Cable Included

IPX6

Powerbank Özelliği  
Powerbank Mode



KOD / CODE	Pil / Battery	Şarj Süresi (Saat) Charging Time (Hour)	g	L mm	TL/Ad.
14000 005383	4000 mAh Li-Ion	3	380	205	1.670,00

14000 005382

400 LM Cob Led Katlanır Çalışma Lambası  
400 LM Cob Led Rotating Work Light

YENİ  
NEW



TEKNİK ÖZELLİKLER / TECHNICAL DATA

Mod / Mode	Yüksek High	Üst Işık Top Light	Tepe Işık Spot Light
Işık Gücü / Output (Lümen / Lumen)	400	150	50
Çalışma Süresi / Battery Life (Saat / Hour)	3	10	40

⚠ Şarj adaptörü dahil değildir / Charger not included



Üst Led 150 LM  
150 LM Top Led

10 LM Kırmızı Cob Led  
10 LM Red Cob Led

400 LM

Ayarlı Sıkıştırma  
Aparatı  
Adjustable Grip

TYPE-C

IPX6



KOD / CODE	Pil / Battery	Şarj Süresi (Saat) Charging Time (Hour)	g	L mm	TL/Ad.
14000 005382	2600 mAh Li-Ion	4	305	158	1.425,00

14000 005386

400 LM Cob Led Çalışma Lambası  
400 LM Cob Led Work Light

YENİ  
NEW

TEKNİK ÖZELLİKLER / TECHNICAL DATA

Mod / Mode	Yüksek High	Orta Middle	Üst Işık Top Light
Işık Gücü / Output (Lümen / Lumen)	400	120	200
Çalışma Süresi / Battery Life(Saat / Hour)	3,5	9	5

⚠ Şarj adaptörü dahil değildir / Charger not included

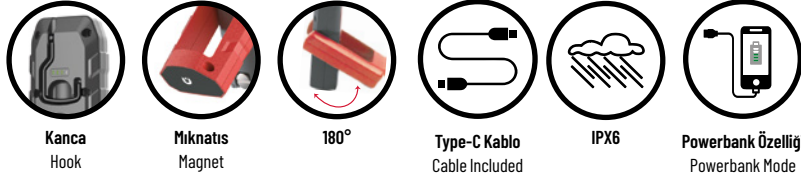

KOD / CODE	Pil / Battery	Şarj Süresi (Saat) Charging Time (Hour)	g	L mm	TL/Ad.
14000 005386	2200 mAh Li-Ion	3	290	180	1.357,50

14000 005384

200 LM Cob Led Çalışma Lambası  
200 LM Cob Led Work Light

YENİ  
NEW

TEKNİK ÖZELLİKLER / TECHNICAL DATA

Mod / Mode	Yüksek High	Orta Middle	Üst Işık Top Light
Işık Gücü / Output (Lümen / Lumen)	200	50	50
Çalışma Süresi / Battery Life(Saat / Hour)	2	8	4

⚠ Şarj adaptörü dahil değildir / Charger not included

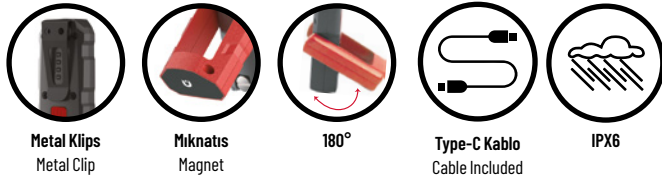

KOD / CODE	Pil / Battery	Şarj Süresi (Saat) Charging Time (Hour)	g	L mm	TL/Ad.
14000 005384	750 mAh Li-Ion	2	155	155	1.012,50

14000 005385

300 LM Cob Led Kalem Tipi Fener  
300 LM Pro Led Pen Light

YENİ  
NEW

TEKNİK ÖZELLİKLER / TECHNICAL DATA

Mod / Mode	Yüksek High	Lazer Laser	Üst Işık Top Light
Işık Gücü / Output (Lümen / Lumen)	300	-	200
Çalışma Süresi / Battery Life(Saat / Hour)	2,5		

⚠ Şarj adaptörü dahil değildir / Charger not included



KOD / CODE	g	L mm	TL/Ad.
14000 005385	100	170	1.042,50



- Maket bıçağı ucu, kullanılmadığı zamanlarda gövdenin içinde kapalı konumda tutulmalıdır.
- Maket bıçağı, kullanımı sırasında kesme yapılan parça sabitlenmeli veya düz bir zemin üzerine konularak kesme işlemi güvenli ve dikkatli bir şekilde gerçekleştirilmelidir.
- Maket bıçağı, kullanımı sırasında kesme yönü vücudumuzdan uzaklaştırma yönünde olmalıdır.
- Maket bıçağı, kullanımı sırasında kesilen parçaya göre elimizden veya vücudumuzdan uzak tutulmalıdır.
- Maket bıçağı, kullanımı sırasında kesici uç kesilecek parçaya göre açılmalıdır. Gereğinden fazla açılan uç kırılmaya sebep olacaktır.
- Maket bıçağını amacı dışında kullanmak kazalara neden olacaktır. (Tornavida - Sıyırıcı - Kazıyıcı gibi)



- Utility knife blade should be kept in the closed position inside the handle when not in use.
- During the use of the utility knife, the material being cut should be secured or placed on a flat surface to ensure safe and careful cutting.
- The cutting direction during the use of the utility knife should be away from our body.
- During the use of the utility knife, we should keep our hands and body away from the cutting area according to the piece being cut.
- The cutting edge of the utility knife should be angled based on the material to be cut. Opening the edge too much can cause breakage.
- Using the utility knife for purposes other than its intended use can lead to accidents (e.g., As a screwdriver, scraper, or chisel).
- During the use of the utility knife, protective gloves and safety glasses should be worn.
- The appropriate utility knife should be chosen according to the type of cutting work to be done.

- Maket bıçağı kullanım sırasında koruyucu eldiven ve gözlük kullanılmalıdır.
- Maket bıçağı, ıslak, nemli ve yağlı ortamlarda muhafaza edilmemelidir.
- Maket bıçağı, yıpranmış ve kırılmış uçlarla kullanılmamalıdır. Yıpranan ve kırılan uç, işaretli yerinden kırılmalı veya yan kesici uc ile kullanılmalıdır. Kırılan ve değiştirilen uçlar ayrı bir kutuda toplanmalıdır.
- Maket bıçağının körelen veya yıpranmış ucu, işaretli yerlerden kıracağımız esnada pense vb. ağızları arasında sıkıca tutularak kırılmalıdır. Böylece vücudunuza zarar vermesinin önüne geçilecektir.
- Maket bıçağı, gövdesi zarar görmüş ve kilit mekanizması bozulmuş ise kullanılmamalıdır.
- Maket bıçağı, kesimi yapılacak işe uygun maket bıçağı seçilerek yapılmalıdır.
- Maket bıçağı ucu, gövdeye takılı olarak kullanılmalıdır. Sadece ucu kullanmak ciddi yaralanmalara sebep olabilir.
- Maket bıçağı, takım dolapları ve takım çantası içerisine konulurken ucunun kapalı olduğundan emin olunmalıdır.

- The utility knife blade should be used with the handle attached to the body. Using only the blade can result in serious injuries.
- When placing the utility knife in tool cabinets and tool bags, make sure that the blade is closed.
- The utility knife should not be stored in wet, humid, or oily environments.
- Worn or broken blades of the utility knife should not be used. They should be discarded in a separate box after breakage and replaced with a new cutting edge.
- When breaking a dull or worn blade of the utility knife from the marked areas, it should be held tightly between the jaws of pliers, etc., To prevent harm to the body.
- Utility knives with damaged bodies or faulty locking mechanisms should not be used.





**IZELTAS®**

# MAKET BIÇAKLARI

UTILITY KNIVES

---

- Maket Bıçakları  
Utility Knives
- Maket Bıçakları Yedek Uçları  
Utility Knives Spare Blades



**Pro Güvenlikli Otomatik Kilitlemeli Trapez Maket Bıçağı (2 Yedek Bıçaklı)**  
Pro Safety Auto- Locking Utility Knife**YENİ  
NEW**

- **Otomatik Kilit Mekanizması** / Auto-Lock Mechanism
- **Metal Gövde** / Metal-Bodied
- **Kauçuk Kaplamalı** / Rubber Coated
- **Ergonomik Yapı** / Ergonomic Design
- **Trapez Bıçak** / Trapeze Knife
- **2 Yedek Bıçaklı** / 2 Spare Blades
- **Otomatik Emniyet Mandalı** / Auto Safety Button
- **Askı Delikli** / Hanging Hole

KOD/CODE	L mm	g	TL/Ad.
14000 005051	175	205	671,00

**Pro Metal Gövde Emniyetli Otomatik Kilitli Maket Bıçağı 18mm**  
Pro Safety Metal-Bodied Auto-Locking Utility Knife 18 mm**YENİ  
NEW**

- **Otomatik Kilit Mekanizması** / Auto-Lock Mechanism
- **Metal Gövde** / Metal-Bodied
- **Kauçuk Kaplamalı** / Rubber Coated
- **Ergonomik Yapı** / Ergonomic Design
- **18 mm Bıçak Genişliği** / 18 mm Blade Width
- **Bıçak Kırma Yeri** / Knife Breaking Part
- **Emniyetli Kesim** / Safety Cutting
- **Askı Delikli** / Hanging Hole

KOD/CODE	L mm	g	TL/Ad.
14000 005050	195	175	549,75

14000 005049

Pro Metal Gövde Maket Bıçağı 18 mm  
Pro Metal-Bodied Utility Knife 18 mm

YENİ  
NEW



- Otomatik Kilit Mekanizması / Auto-Lock Mechanism
- Metal Gövde / Metal-Bodied
- Kauçuk Kaplamalı / Rubber Coated
- Ergonomik Yapı / Ergonomic Design
- 18 mm Bıçak Genişliği / 18 mm Blade Width
- Bıçak Kırma Yeri / Knife Breaking Part
- Askı Delikli / Hanging Hole

KOD/CODE	L mm			TL/Ad.
14000 005049	172	85	12	338,50

14000 005047

Pro Metal Gövde Otomatik Yükllemeli Maket Bıçağı (5 Yedekli ) 9 mm  
Pro Metal-Bodied Auto-Loading Utility Knife 9 mm

YENİ  
NEW



- Otomatik Kilit Mekanizması / Auto-Lock Mechanism
- Metal Gövde / Metal-Bodied
- Kauçuk Kaplamalı / Rubber Coated
- Ergonomik Yapı / Ergonomic Design
- 9 mm Bıçak Genişliği / 9 mm Blade Width
- Otomatik Yükllemeli / Auto Loading
- Askı Delikli / Hanging Hole
- 5 Adet Yedek Bıçaklı / 5 Spare Blades

KOD/CODE	L mm			TL/Ad.
14000 005047	136	80	12	353,00



14000 005053

Pro Metal Gövde Maket Bıçağı 30° 9 mm  
Pro Metal-Bodied Utility Knife 30° Angled 9 mm

YENİ  
NEW



- Otomatik Kilit Mekanizması / Auto-Lock Mechanism
- Metal Gövde / Metal-bodied
- 9 mm Bıçak Genişliği / 9 mm Blade Width

KOD/CODE	L mm	g		TL/Ad.
14000 005053	134	15	24	71,00

14000 005052

Pro Metal Gövde Maket Bıçağı 9 mm  
Pro Metal-Bodied Utility Knife 9 mm

YENİ  
NEW



- Otomatik Kilit Mekanizması / Auto-Lock Mechanism
- Metal Gövde / Metal-bodied
- 9 mm Bıçak Genişliği / 9 mm Blade Width
- Kauçuk Kaplamalı / Rubber Coated
- Ergonomik Yapı / Ergonomic Design
- Askı Delikli / Hanging Hole

KOD/CODE	L mm	g		TL/Ad.
14000 005052	130	50	12	240,00

14000 005048

Pro Metal Gövde Emniyetli Otomatik Kilitli Maket Bıçağı 9 mm  
Pro Safety Metal Bodied Auto-Locking Utility Knife 9 mm

YENİ  
NEW



- Otomatik Kilit Mekanizması / Auto-Lock Mechanism
- Metal Gövde / Metal-bodied
- 9 mm Bıçak Genişliği / 9 mm Blade Width
- Kauçuk Kaplamalı / Rubber Coated
- Ergonomik Yapı / Ergonomic Design
- Emniyetli Kesim / Safety Cutting
- Askı Delikli / Hanging Hole

KOD/CODE	L mm	g		TL/Ad.
14000 005048	162	75	12	422,50

14000 005090

Pro Güvenlikli Trapez Maket Bıçağı Yedek Bıçak 18 mm  
Pro Safety Utility Knife Spare Blade 18 mm

YENİ  
NEW



Bir Paket 10 Bıçak, Bir Kutu 24 Paket

One Package Contains 10 Blades, One Box Contains 24 Packages

KOD/CODE	Ölçü / SIZE (mm)		TL/Ad.
14000 005090	18	24	108,00

14000 005088

Pro Maket Bıçağı Yedek Bıçak 18 mm  
Pro Utility Knife Spare Blade 18 mm

YENİ  
NEW



Bir Paket 10 Bıçak, Bir Kutu 24 Paket

One Package Contains 10 Blades, One Box Contains 24 Packages

KOD/CODE	Ölçü / SIZE (mm)		TL/Ad.
14000 005088	18	24	85,25

14000 005089

Pro Maket Bıçağı Yedek Bıçak 9mm  
Pro Utility Knife Spare Blade 9 mm

YENİ  
NEW



Bir Paket 10 Bıçak, Bir Kutu 24 Paket

One Package Contains 10 Blades, One Box Contains 24 Packages

KOD/CODE	Ölçü / SIZE (mm)		TL/Ad.
14000 005089	9	24	54,00

14000 005091

Pro Maket Bıçağı Yedek Bıçak 30° Açılı 9 mm  
Pro Utility Knife Spare Blade 30° 9 mm

YENİ  
NEW



Bir Paket 10 Bıçak, Bir Kutu 24 Paket

One Package Contains 10 Blades, One Box Contains 24 Packages

KOD/CODE	Ölçü / SIZE (mm)		TL/Ad.
14000 005091	9	24	54,00

# MAKASLAR

## SHEARS

- Demir Kesme Makası  
Bolt Cutters
- Sac Makasları  
Sheet Metal Cutters
- Özel Amaçlı Makaslar  
Special Purpose Shears
- Baę Makasları  
Pruning Shears
- Boru Kesiciler  
Pipe Cutters



**Isıl işlem sonrasında ilave  
indüksiyonla sertleştirme ile kullanım  
ömrü arttırılmış kesici ağızlar**  
Heat-treated and induction hardened cutting  
edges for long lifetime

**PVC izoleli sap**  
PVC coated handle

**Kolları birleştirmeye  
yarayan kilit mandalı**  
Locking latch to keep the  
arms closed

**Uzun ömürlü yay**  
Long life spring

**Mangan Fosfat Kaplı  
Yüzeyler**  
Black finish

**Yüksek karbonlu  
sıcak dövme  
çeliği ile arttırılmış  
dayanım**  
High carbon hot forged  
steel for improved  
performance



IZELTAS YOUTUBE



2350

**Demir Kesme Makası**  
Bolt Cutters



 Yedek parça sayfa 255-259  
Spare parts page 255-259

Özel alaşımli çelik, Kesici ağızlar indüksiyonda sertleştirilmiş,  
Elektrostatik boyanmış çeneler ve bağlantı parçaları dövme  
Special steel, Cutters induction hardened,  
Electrostatically painted jaws and connection parts drop forged

KOD CODE	L mm	L inch	KAPASİTE CAPACITY ϕ mm	g	TL/Ad.
2350 27 0018	450	18"	6 - 8	1510	1 2.541,75
2350 27 0024	600	24"	8 - 10	2350	1 3.741,75
2350 27 0030	750	30"	9 - 13	3750	1 5.856,00
2350 27 0036	900	36"	11 - 16	5500	1 7.579,25

2350 00 6104

**Demir Kesme Makası Sehpası (Dolu)**  
Bolt Cutters Frame



KOD CODE	İÇERİK CONTENTS	g	TL/Ad.
2350 00 6104	18"(450) - 24"(600) 30"(750) - 36"(900)	21.110	4 24.218,75

6205 27 0240

**Alüminyum Ve Sac Kesme Makası Sağ**  
Snip For Aluminum and Metal Sheet (Right)



Özel alaşımli çelik, Kesici ağızlar indüksiyonda sertleştirilmiş,  
Special steel, Cutters induction hardened,

KOD CODE	L mm	L inch	g	TL/Ad.
6205 27 0240	240	10"	380	5 1.005,75

6206 27 0240

**Alüminyum Ve Sac Kesme Makası Sol**  
Snip For Aluminum and Metal Sheet (Left)



Özel alaşımli çelik, Kesici ağızlar indüksiyonda sertleştirilmiş  
Special steel, Cutters induction hardened

KOD CODE	L mm	L inch	g	TL/Ad.
6206 27 0240	240	10"	380	5 1.005,75

6207 27 0240

**Alüminyum Ve Sac Kesme Makası Düz**  
Snip For Aluminum and Metal Sheet (Flat)



Özel alaşımli çelik, Kesici ağızlar indüksiyonda sertleştirilmiş  
Special steel, Cutters induction hardened

KOD CODE	L mm	L inch	g	TL/Ad.
6207 27 0240	240	10"	380	5 1.005,75

13000 001851

**Alüminyum Ve Sac Kesme Makas Takımı (3 Parça)**  
Aluminum and Metal Sheet Set (3 Pcs)

**YENİ**  
**NEW**



KOD CODE	L mm	L inch	g	TL/Ad.
13000 001851	240	10"	1140	5 3.017,25

6210

**Kaportacı Makası (Sağ)**  
Punch Snip (Right)

DIN 6438



Özel alaşımli çelik, Kesici ağızlar indüksiyonda sertleştirilmiş, PVC izoleli  
Special steel, Cutters induction hardened, PVC insulated

KOD CODE	L mm	L inch	g		TL/Ad.
6210 27 0250	250	10"	555	5	1.263,75
6210 27 0275	275	11"	600	5	1.382,50
6210 27 0300	300	12"	640	5	1.575,75

6211

**Kaportacı Makası (Sol)**  
Punch Snip (Left)

DIN 6438



Özel alaşımli çelik, Kesici ağızlar indüksiyonda sertleştirilmiş, PVC izoleli  
Special steel, Cutters induction hardened, PVC insulated

KOD CODE	L mm	L inch	g		TL/Ad.
6211 27 0250	250	10"	535	5	1.263,75
6211 27 0275	275	11"	605	5	1.382,50
6211 27 0300	300	12"	665	5	1.575,75

6820

**Tenekeci Makası**  
Tinman's Snip

TSEK



Özel alaşımli çelik, Kesici ağızlar indüksiyonda sertleştirilmiş, PVC izoleli  
Special steel, Cutters induction hardened, PVC insulated

KOD CODE	L mm	L inch	g		TL/Ad.
6820 27 0200	200	8"	320	5	849,75
6820 27 0250	250	10"	575	5	1.086,00
6820 27 0300	300	12"	870	5	1.183,25

6821

**Tenekeci Makası (Yaylı)**  
Tinman's Snip (With Spring)

TSEK



Özel alaşımli çelik, Kesici ağızlar indüksiyonda sertleştirilmiş, PVC izoleli  
Special steel, Cutters induction hardened, PVC insulated

KOD CODE	L mm	L inch	g		TL/Ad.
6821 27 0250	250	10"	575	5	1.179,75
6821 27 0300	300	12"	895	5	1.289,00

6800 27 0180

Kuyumcu Makası (Düz)  
Jeweller's Snip (Straight)

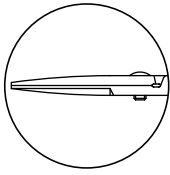

KOD CODE	L mm	L inch	g	TL/Ad.
6800 27 0180	180	7 1/8"	140	5 1.026,00

6801 27 0180

Kuyumcu Makası (Eğri)  
Jeweller's Snip (Curved)

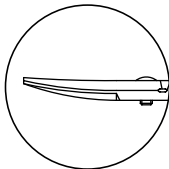

KOD CODE	L mm	L inch	g	TL/Ad.
6801 27 0180	180	7 1/8"	140	5 1.122,00

6815 27 0200

Tel Kesme Makası  
Bolt Cutters



KOD CODE	L mm	L inch	g	TL/Ad.
6815 27 0200	200	8"	295	5 519,75

13000 005122

Dövme Tel Kesme Makası  
Forging Bolt Cutters

YENİ  
NEW



Özel alaşımli çelik, Kesici ağızlar indüksiyonda sertleştirilmiş, PVC izoleli  
Special steel, Cutters induction hardened, PVC insulated

KOD CODE	L mm	L inch	g	TL/Ad.
13000 005122	210	7 1/8"	345	5 1.899,75

6740

Kombine Makas  
Multi Purpose Scissors



KOD CODE	L mm	L inch	g	TL/Ad.
6740 27 0140	140	5 1/2"	60	5 939,75
6740 27 0190	190	7 1/2"	120	5 1.101,75

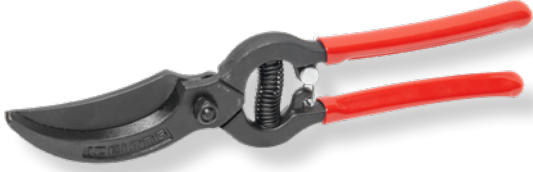

**6710 27 0230****Bağ Makası (Lüks)**  
Pruning Shears (Lux)

İZELTAS YOUTUBE

Özel alaşımlı çelik, Kesici ağızlar indüksiyonda sertleştirilmiş, PVC izoleli  
Special steel, Cutters induction hardened, PVC insulated

KOD CODE	L mm	L inch	g	TL/Ad.
6710 27 0230	230	9"	290	5 907,25

**6715 27 0225****Bağ Makası (Comfort)**  
Pruning Shears (Comfort)

Özel alaşımlı çelik, PVC izoleli  
Special steel, PVC insulated

KOD CODE	L mm	L inch	g	TL/Ad.
6715 27 0225	225	9"	340	5 1.379,00

**6720 27 0220****Bağ Makası (Hafif Tip)**  
Pruning Shears (Light)

Alüminyum gövde, PVC izoleli  
Aluminum forged body, PVC insulated

KOD CODE	L mm	L inch	g	TL/Ad.
6720 27 0220	220	8 5/8"	265	5 1.601,00

**6712 27 0210****Elma Makası**  
Pruning Shears (Fruit)**YENİ TASARIM**  
NEW DESIGN

Özel alaşımlı çelik, Kesici ağızlar indüksiyonda sertleştirilmiş, PVC izoleli  
Special steel, Cutters induction hardened, PVC insulated

KOD CODE	L mm	L inch	g	TL/Ad.
6712 27 0210	200	8"	260	5 1.603,25

14000 005137

**Budama Makası Dövme Örs Çeneli**  
Anvil Pruning Shears



Alüminyum gövde, PVC izoleli  
Aluminum forged body, PVC insulated

KOD CODE	L mm	L inch	g	TL/Ad.
14000 005137	210	8 1/4"	250	1.098,00

14000 005136

**Bağ Makası (Alüminyum Gövdeli)**  
Pruning Shears (Aluminum-Bodied)



Alüminyum gövde  
Aluminum forged body

KOD CODE	L mm	L inch	g	TL/Ad.
14000 005136	220	8 5/8"	315	1.267,25

14000 005138

**Hasat Makası Paslanmaz Düz Ağızlı**  
Stainless Steel Straight-Edge Harvesting Shears



Paslanmaz Çelik  
Stainless Steel

KOD CODE	L mm	L inch	g	TL/Ad.
14000 005138	190	7 1/2"	85	648,00

**06760****Plastik Boru Kesme Makası**  
Plastic Pipe Cutter

Yedek parça sayfa 255-259  
Spare parts page 255-259

KOD CODE	Ø mm	g	TL/Ad.
06760 50 042	42	400	5 3.463,25
06760 50 063	63	610	5 6.075,75

**6850 28 0322****Mini Boru Kesici (Bakır ve Alüminyum İçin)**  
Mini Tube Cutter (For Copper and Aluminum)

Yedek parça sayfa 255-259  
Spare parts page 255-259

KOD CODE	ÖLÇÜ SIZE	g	TL/Ad.
6850 28 0322	1/8" - 5/8"	120	1 747,75

**6855 28 0330****Standart Boru Kesici (Bakır ve Alüminyum İçin)**  
Standard Tube Cutter (For Copper and Aluminum)

Yedek parça sayfa 255-259  
Spare parts page 255-259

KOD CODE	ÖLÇÜ SIZE	g	TL/Ad.
6855 28 0330	1/8" - 1 1/8"	305	1 1.034,50

**6860 28 0635****Teleskopik Boru Kesici (Bakır ve Alüminyum İçin)**  
Telescopic Tube Cutter (For Copper and Aluminum)

Yedek parça sayfa 255-259  
Spare parts page 255-259

KOD CODE	ÖLÇÜ SIZE	g	TL/Ad.
6860 28 0635	1/8" - 1 3/8"	470	1 2.197,25

**6865 28 1050****Profesyonel Boru Kesici (Çelik İçin)**  
Professional Tube Cutter (For Steel)

Yedek parça sayfa 255-259  
Spare parts page 255-259

KOD CODE	ÖLÇÜ SIZE	g	TL/Ad.
6865 28 1050	1/8" - 2"	2380	1 5.544,00



# ÇEKTİRMELER

## PULLERS

- Çektirmeler  
Pullers
- İç Rulman Çektirmeler  
Internal Pullers
- Dış Rulman Çektirmeler  
Seperator Pullers
- Rotil Çektirme  
Balljoint Pullers



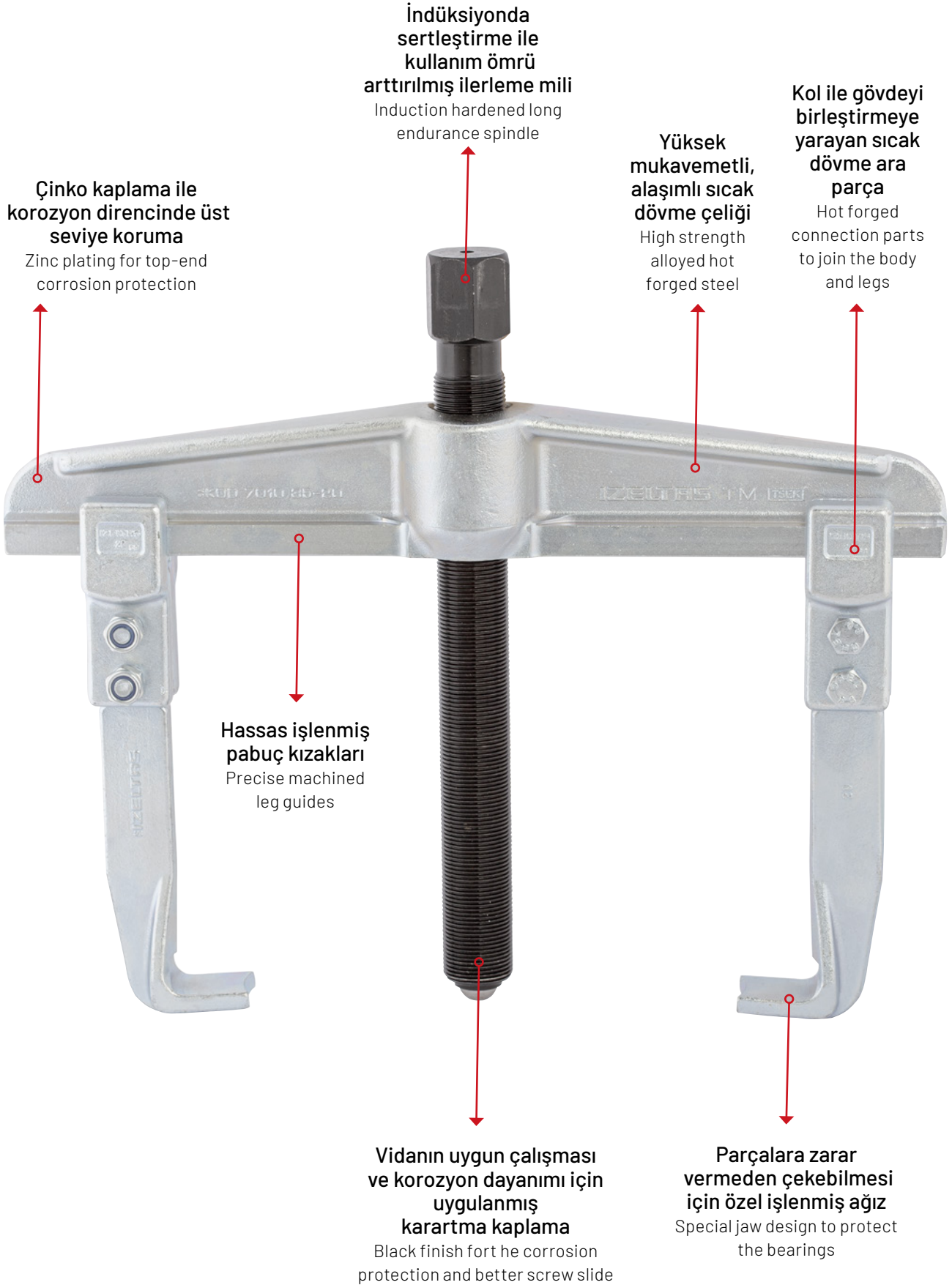

**STANDART ÇEKTİRME İKİ KOLLU / STANDARD PULLER TWO ARMS**

**7010**
**Standart Çektirme (iki Kollu)**  
 Standard Puller (Two Arms)

TSEK

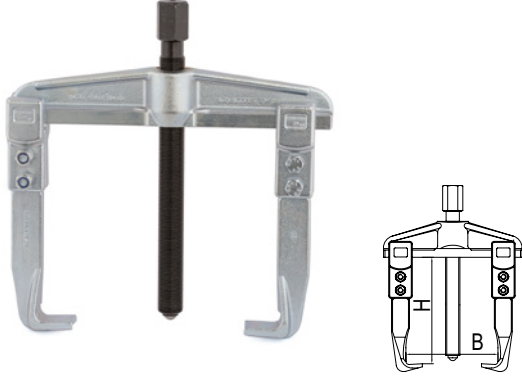

 Yedek parça sayfa 255-259  
 Spare parts page 255-259



 Krom vanadyum, Çinko kaplı, Kollar sertleştirilmiş,  
 Mil indüksiyonda sertleştirilmiş  
 Chrom vanadium, Zinc plated,  
 Arms hardened, Spindle induction hardened

KOD CODE		B mm	H mm	 g		TL/Ad.
7010 29 0810	8x10	80	100	1080	1	2.543,00
7010 29 1210	12x10	120	100	1235	1	2.719,25
7010 29 1615	16x15	160	150	2850	1	4.634,50
7010 29 2015	20x15	200	150	3060	1	5.069,00
7010 29 2520	25x20	250	200	7450	1	8.755,25
7010 29 3520	35x20	350	200	10000	1	10.633,25
7010 29 5220	52x20	520	200	14100	1	15.630,00

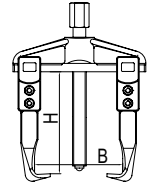
**7020**
**Standart Çektirme (Üç Kollu)**  
 Standart Puller (Three Arms)

TSEK



 Yedek parça sayfa 255-259  
 Spare parts page 255-259

 Krom vanadyum, Çinko kaplı, Kollar sertleştirilmiş,  
 Mil indüksiyonda sertleştirilmiş  
 Chrom vanadium, Zinc plated,  
 Arms hardened, Spindle induction hardened

KOD CODE		B mm	H mm	 g		TL/Ad.
7020 29 3720	37x20	370	200	14750	1	19.621,25
7020 29 5220	52x20	520	200	20000	1	27.048,00

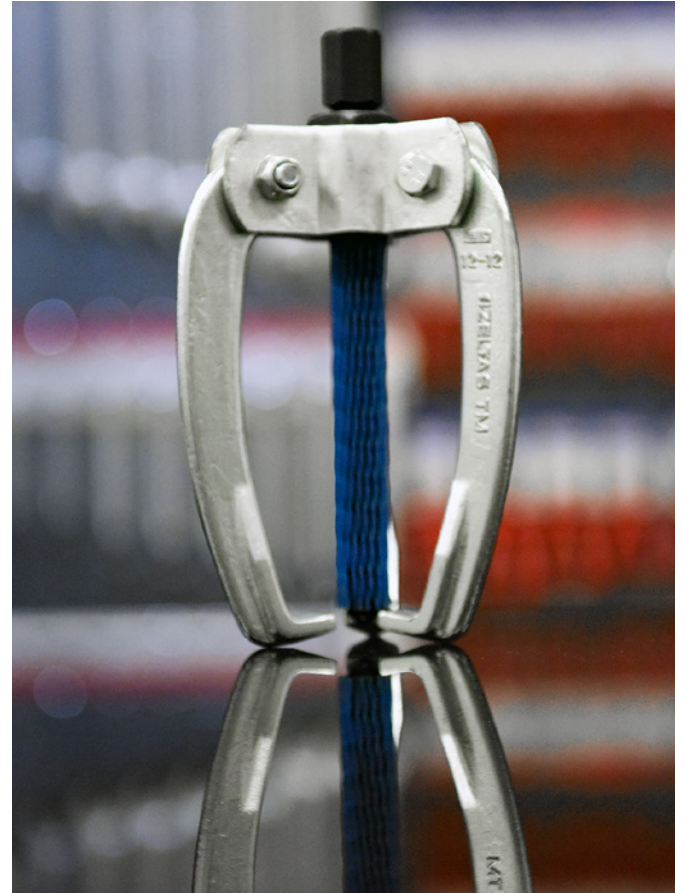
**7010 00 6105**
**Standart Çektirme Sehpası (Dolu)**  
 Display Frame For Pullers

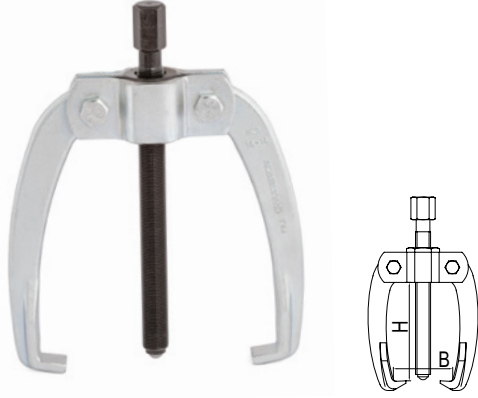
KOD CODE	İÇERİK CONTENTS	 g		TL/Ad.
7010 00 6105	8x10 - 12x10 - 16x15 20x15 - 25x20	17840	5	24.666,75



**7030**
**Master Çektirme (iki Kollu)**  
 Master Puller (Two Arms)

**Yedek parça sayfa 255-259**  
*Spare parts page 255-259*

**Krom vanadyum, Çinko kaplı, Kollar sertleştirilmiş,  
 Mil indüksiyonda sertleştirilmiş**  
 Chrom vanadium, Zinc plated,  
 Arms hardened, Spindle induction hardened

KOD CODE		B mm	H mm	g		TL/Ad.
7030 29 0808	8x8	80	80	545	1	1.025,00
7030 29 1212	12x12	120	120	1075	1	2.112,00
7030 29 1616	16x16	160	160	1885	1	3.177,75
7030 29 2320	23x20	230	200	3240	1	4.320,00

**7040**
**Master Çektirme (Üç Kollu)**  
 Master Puller (Three Arms)

**Yedek parça sayfa 255-259**  
*Spare parts page 255-259*

**Krom vanadyum, Çinko kaplı, Kollar sertleştirilmiş,  
 Mil indüksiyonda sertleştirilmiş**  
 Chrom vanadium, Zinc plated,  
 Arms hardened, Spindle induction hardened

KOD CODE		B mm	H mm	g		TL/Ad.
7040 29 0808	8x8	80	80	680	1	1.962,00
7040 29 1212	12x12	120	120	1355	1	2.871,75
7040 29 1616	16x16	160	160	2320	1	4.221,75
7040 29 2320	23x20	230	200	4025	1	5.683,25

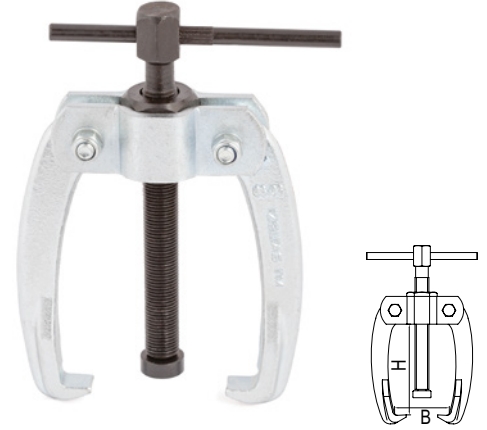
**7050**
**Batarya Çektirme (iki Kollu)**  
 Battery Puller (Two Arms)

**Yedek parça sayfa 255-259**  
*Spare parts page 255-259*

**Krom vanadyum, Çinko kaplı, Kollar sertleştirilmiş,  
 Mil indüksiyonda sertleştirilmiş**  
 Chrom vanadium, Zinc plated,  
 Arms hardened, Spindle induction hardened

KOD CODE		B mm	H mm	g		TL/Ad.
7050 29 0604	6x4	60	40	245	1	1.140,00
7050 29 0606	6x6	60	60	275	1	1.176,00
7050 29 0808	8x8	80	80	555	1	1.235,00

**7060**
**Batarya Çektirme (Üç Kollu)**  
 Battery Puller (Three Arms)



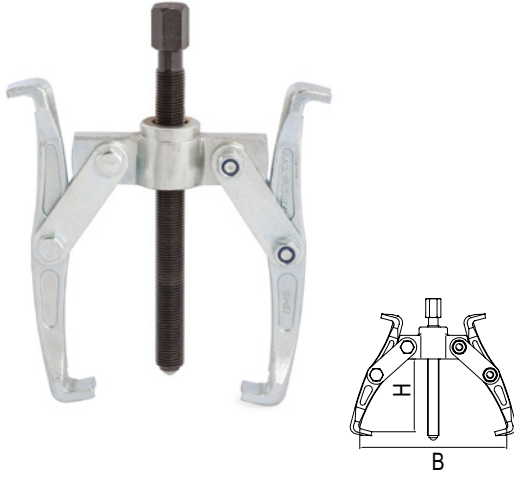

**Yedek parça sayfa 255-259**  
*Spare parts page 255-259*

**Krom vanadyum, Çinko kaplı, Kollar sertleştirilmiş,  
 Mil indüksiyonda sertleştirilmiş**  
 Chrom vanadium, Zinc plated,  
 Arms hardened, Spindle induction hardened

KOD CODE		B mm	H mm	g		TL/Ad.
7060 29 0604	6x4	60	40	300	1	1.481,00
7060 29 0606	6x6	60	60	345	1	1.866,00
7060 29 0808	8x8	80	80	715	1	2.163,75

**7070 29 2013**
**S Tipi Çektirme (İki Kollu)**  
**S Type Puller (Two Arms)**

 **Yedek parça sayfa 255-259**  
*Spare parts page 255-259*  
**Krom vanadyum, Çinko kaplı, Kollarsertleştirilmiş,**  
**Mil indüksiyonda sertleştirilmiş**  
**Chrom vanadium, Zinc plated,**  
**Arms hardened, Spindle induction hardened**

KOD CODE		B mm	H mm	 g		TL/Ad.
7070 29 2013	20x13	200	130	2420	1	2.807,00

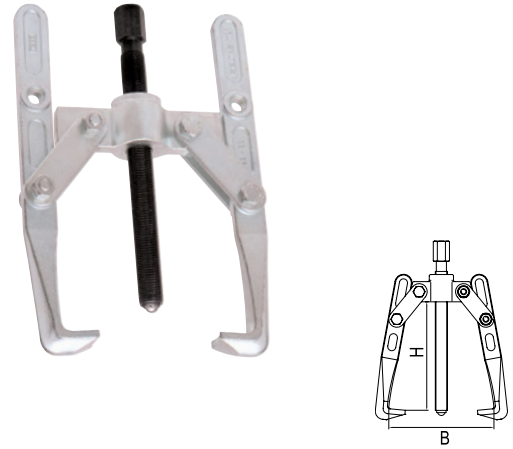

**7090 29 2022**
**Üniversal Çektirme (İki Kollu)**  
**Universal Puller (Two Arms)**

 **Yedek parça sayfa 255-259**  
*Spare parts page 255-259*  
**Krom vanadyum, Çinko kaplı, Kollar sertleştirilmiş,**  
**Mil indüksiyonda sertleştirilmiş**  
**Chrom vanadium, Zinc plated,**  
**Arms hardened, Spindle induction hardened**

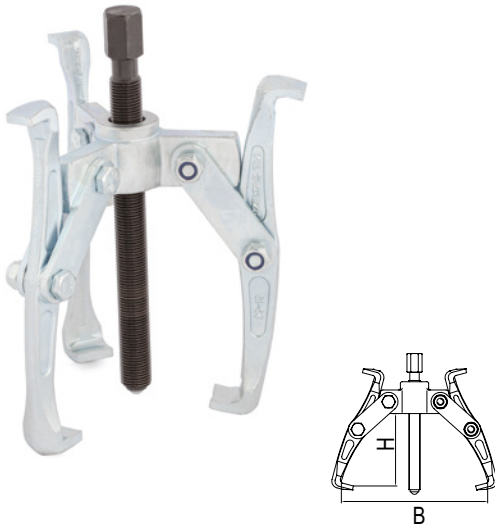
KOD CODE		B mm	H mm	 g		TL/Ad.
7090 29 2022	22x22	220	220	3085	1	3.117,75



**7080 29 2013**
**S Tipi Çektirme (Üç Kollu)**  
**S Type Puller (Three Arms)**

 **Yedek parça sayfa 255-259**  
*Spare parts page 255-259*  
**Krom vanadyum, Çinko kaplı, Kollar sertleştirilmiş,**  
**Mil indüksiyonda sertleştirilmiş**  
**Chrom vanadium, Zinc plated,**  
**Arms hardened, Spindle induction hardened**

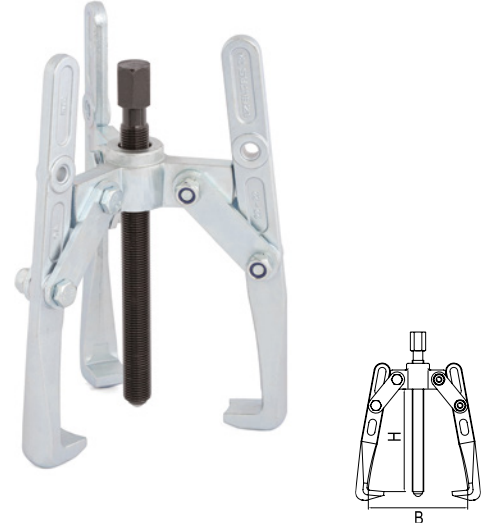
KOD CODE		B mm	H mm	 g		TL/Ad.
7080 29 2013	20x13	200	130	3250	1	3.619,25

**7100 29 2022**
**Üniversal Çektirme (Üç Kollu)**  
**Universal Puller (Three Arms)**

 **Yedek parça sayfa 255-259**  
*Spare parts page 255-259*  
**Krom vanadyum, Çinko kaplı, Kollar sertleştirilmiş,**  
**Mil indüksiyonda sertleştirilmiş**  
**Chrom vanadium, Zinc plated,**  
**Arms hardened, Spindle induction hardened**

KOD CODE		B mm	H mm	 g		TL/Ad.
7100 29 2022	22x22	220	220	4125	1	4.087,25

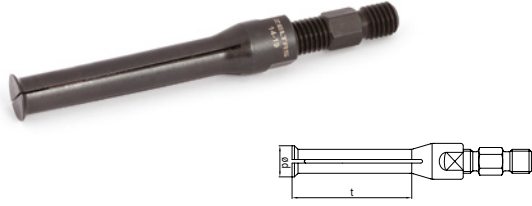

**İç Rulman Çektirme Pensleri - Model A**  
 Internal Expansion Puller - Model A

KOD CODE	σD mm	t mm	Kullanılan Kol / For	Adaptör vidası	g	TL/Ad.
7120 29 0507	5 - 7	30	35 - 75	M10	40	2.339,00
7120 29 0709	7 - 9	30	35 - 75	M10	40	2.339,00
7120 29 0912	9 - 12	30	35 - 75	M10	40	2.167,25
7120 29 1013	10 - 13	30	35 - 75	M10	40	2.167,25
7120 29 1317	13 - 17	50	35 - 75	M10	60	2.167,25
7120 29 1419	14 - 19	60	35 - 75	M10	75	2.220,00
7120 29 1621	16 - 21	60	35 - 75	M10	75	2.220,00
7120 29 1823	18 - 23	60	35 - 75	M10	100	2.657,00
7120 29 2025	20 - 25	60	35 - 75	M10	100	2.804,50
7120 29 2530	25 - 30	60	35 - 75	M10	110	2.922,00
7120 29 3037	30 - 37	70	35 - 75 60 - 130	M10	250	3.384,00
7120 29 3542	35 - 42	70	35 - 75 60 - 130	M10	250	3.557,00
7120 29 3845	38 - 45	70	35 - 75 60 - 130	M10	250	3.750,00
7120 29 4350	43 - 50	70	35 - 75 60 - 130	M10	400	4.263,75

**7120 29 2540**
**İç Rulman Çektirme Pensleri - Model B**  
 Internal Expansion Puller - Model B

KOD CODE	σD mm	t mm	Kullanılan Kol / For	Adaptör vidası	g	TL/Ad.
7120 29 2540	25 - 40	45	35 - 75 60 - 130	M10	235	4.734,00

**İç Rulman Çektirme Kolları**  
 Arms For Internal Expansion Puller

**Krom vanadyum, Çinko kaplı, Kollar sertleştirilmiş,  
Mil indüksiyonda sertleştirilmiş**  
 Chrom vanadium, Zinc plated,  
 Arms hardened, Spindle induction hardened

KOD CODE	Kapasite Capacity mm	Kullanılan pensler / For	Adaptör vidası Screw Adapter	g	TL/Ad.
----------	----------------------	--------------------------	------------------------------	---	--------

7120 29 3575	35 - 75	Model A 5 - 7'den 43 - 50'ye Model B 25 - 40	M10	625	1 2.382,00
--------------	---------	----------------------------------------------------------	-----	-----	------------

7120 29 6013	60 - 130	Model A 30 - 37'den 43 - 50'ye Model B 25 - 40	M10	1000	1 4.825,25
--------------	----------	------------------------------------------------------------	-----	------	------------



7122

**Dış Rulman Çektirme Çeneleri**  
Seperator



Krom vanadyum, Çinko kaplı, Kollar sertleştirilmiş,  
Mil indüksiyonda sertleştirilmiş  
Chrom vanadium, Zinc plated,  
Arms hardened, Spindle induction hardened

KOD CODE	Ø mm	Kullanılan Kollar / For	Adaptör vidası	g	TL/Ad.
7122 29 0560	5 - 60	40 - 115	M12	370	1 3.615,75
7122 29 1275	12 - 75	40 - 115	M12	635	1 4.529,00
7122 29 2211	22 - 115	55 - 205	M16	1780	1 7.070,50
7122 29 2515	25 - 155	90 - 260	M20x1.5	3940	1 11.069,00
7122 29 3022	30 - 220	100 - 360	M20x1.5	11000	1 30.246,00
7122 29 4028	40 - 280	140 - 435	M24x3	15000	1 67.553,00

7122

**Dış Rulman Çektirme Kolları**  
Puller Arms For Separator

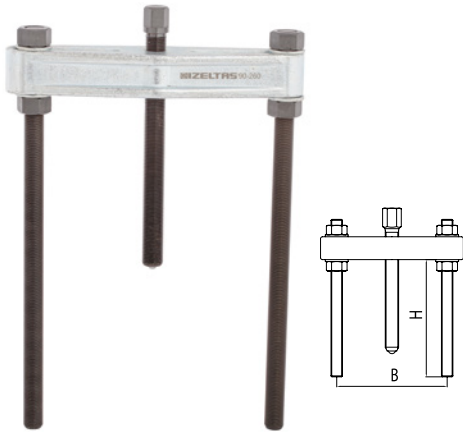

Krom vanadyum, Çinko kaplı, Mil indüksiyonda sertleştirilmiş  
Chrom vanadium, Zinc plated,  
Arms Spindle induction hardened

KOD CODE	B mm	H mm	Kullanılan Çene / For	Adaptör vidası	g	TL/Ad.
7122 29 4011	40-115	150	5 - 60 12 - 75	M12	990	1 6.737,00
7122 29 5520	55-205	210	22 - 115	M16	2700	1 10.663,25
7122 29 9026	90-260	315	25 - 155	M20x1.5	4965	1 15.097,25
7122 29 1036	100-360	305	30 - 220	M20x1.5	7000	1 31.067,00
7122 29 1443	140-435	320	40 - 280	M24x3	11000	1 60.719,00

7126

**Rotil Çektirme**  
Extractor For Ball Joint

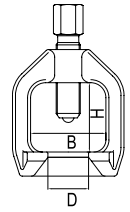

KOD CODE	øD mm	B mm	H mm	g	TL/Ad.
7126 29 0018	18	40	40	315	1 2.028,00
7126 29 0025	25	50	50	540	1 2.779,25
7126 29 0029	29	60	60	915	1 3.697,25
7126 29 0040	40	80	80	1965	1 5.217,75
7126 29 0045	45	90	100	2670	1 6.588,00









# elta

- Anahtarlar  
Wrenches
- Lokma Anahtarları  
Sockets Wrenches
- Boru Anahtarları ve Penseler  
Pipe Wrenches and Pliers
- Tornavida ve Allen Anahtarlar  
Screwdrivers and Hex Key Wrenches
- Keskiler  
Chisels
- Genel El Aletleri  
General Hand Tools
- Makaslar  
Shears
- Maket Bıçakları  
Utility Knives



elta

elta bir IZELTAS markasıdır



İki Ağız Anahtar (mm)  
Double Ended Open Jaw Wrench (mm)



TS 81  
DIN 895

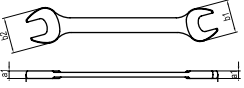

Krom vanadyum, Krom kaplı  
Chrom vanadium, Chrom plated

0150

İki Ağız Anahtar Takımı (mm)  
Double Ended Open Jaw Wrench Set (mm)



KOD CODE	mm	L mm	a1 mm	b1 mm	b2 mm	g	□	TL/Ad.
0150 01 0607	6x7	98	3.3	13.5	15.5	10	10	78,00
0150 01 0809	8x9	108	3.6	17.5	19.5	20	10	79,25
0150 01 1011	10x11	120	4.1	21.5	23.5	30	10	86,50
0150 01 1213	12x13	134	4.5	25.5	27.5	40	10	95,00
0150 01 1415	14x15	150	5	29.5	31.5	60	10	110,50
0150 01 1617	16x17	163	5.5	33.5	35.5	85	10	127,25
0150 01 1819	18x19	178	6	37.5	39.5	110	10	135,75
0150 01 2022	20x22	198	6.5	41.5	45.5	145	10	155,00
0150 01 2123	21x23	218	6.9	43.5	47.5	175	10	168,00
0150 01 2426	24x26	236	7.4	49.5	53.5	235	10	193,25
0150 01 2528	25x28	250	7.8	51.5	57.5	275	10	231,75
0150 01 2732	27x32	265	8.3	55.5	65.5	345	10	276,00

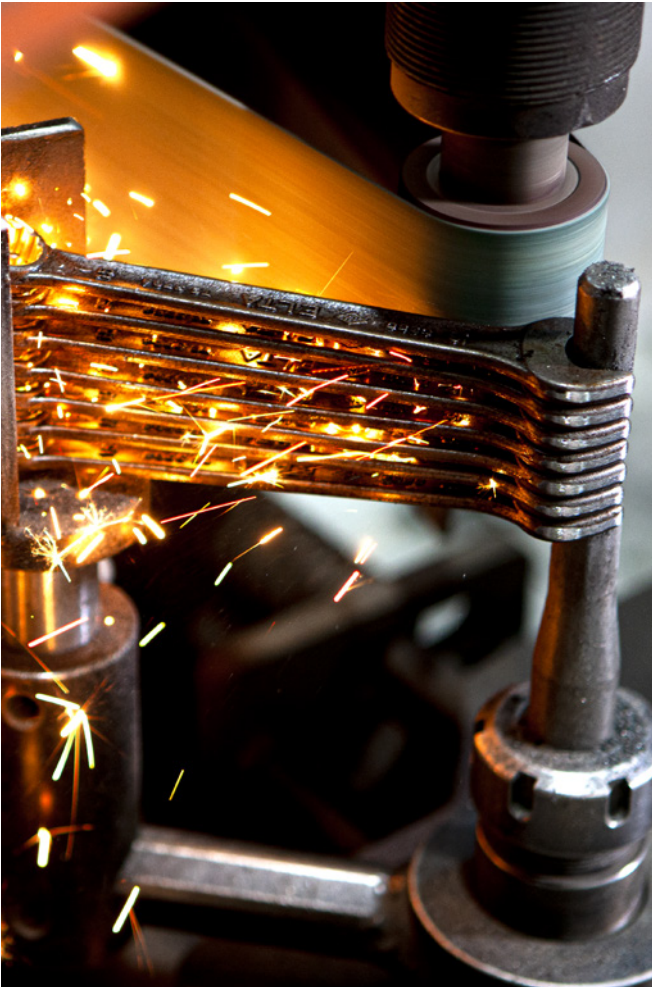

KOD CODE	İÇERİK CONTENTS	g	□	TL/Ad.
0150 00 2108	6x7 - 8x9 - 10x11 12x13 - 14x15 - 16x17 18x19 - 20x22	560	8	867,25
0150 00 2112	6x7 - 8x9 - 10x11 12x13 - 14x15 - 16x17 18x19 - 20x22 - 21x23 24x26 - 25x28 - 27x32	1590	12	1.736,25

0350

Kombine Anahtar (mm)  
Combination Wrench (mm)



TS 3794  
TS ISO 7738 Form A  
DIN 3113

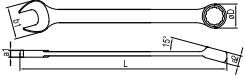

Krom vanadyum, Krom kaplı  
Chrom vanadium, Chrom plated

0350

Kombine Anahtar Takımı (mm)  
Combination Wrench Set (mm)



KOD CODE	mm	L mm	a1 mm	a2 mm	b1 mm	øD mm	g	TL/Ad.
0350 02 0006	6	95	3.1	5.1	13.5	10	15	10
0350 02 0007	7	104	3.3	5.5	15.5	11.5	15	10
0350 02 0008	8	112	3.7	5.9	17.5	13	20	10
0350 02 0009	9	121	3.9	6.3	19.5	14	25	10
0350 02 0010	10	130	4.3	6.9	21.5	15.5	30	10
0350 02 0011	11	138	4.5	7.3	23.5	16.5	35	10
0350 02 0012	12	146	4.9	7.7	25.5	18	45	10
0350 02 0013	13	154	5.1	8.1	27.5	19	50	10
0350 02 0014	14	163	5.5	8.7	29.5	21.5	60	10
0350 02 0015	15	171	5.7	9.1	31.5	22	70	10
0350 02 0016	16	180	6.1	9.5	33.5	23	85	10
0350 02 0017	17	189	6.3	9.9	35.5	25	95	10
0350 02 0018	18	200	6.7	10.4	37.5	26.5	110	10
0350 02 0019	19	211	6.9	11	39.5	28	130	10
0350 02 0020	20	222	7.3	11.4	41.5	29.5	145	10
0350 02 0021	21	235	7.3	11.4	43.5	31	160	10
0350 02 0022	22	250	8.1	12.6	45.5	32.5	200	10
0350 02 0024	24	270	8.7	13.6	49.5	36	250	5
0350 02 0027	27	300	9.6	14.8	55.5	40	350	5
0350 02 0030	30	330	10.2	15.8	61.5	44.5	445	5
0350 02 0032	32	350	10.4	16.2	65.5	47	500	5



KOD CODE	İÇERİK CONTENTS	g	TL/Ad.
0350 00 2108	6 - 7 - 8 - 9 - 10 - 13 17 - 19	395	8
0350 00 2112	8 - 9 - 10 - 11 - 12 13 - 14 - 15 - 16 17 - 19 - 22	855	12
0350 00 2117	6 - 7 - 8 - 9 - 10 11 - 12 - 13 - 14 15 - 16 - 17 - 18 19 - 20 - 21 - 22	1300	17
0350 00 2121	6 - 7 - 8 - 9 - 10 11 - 12 - 13 - 14 15 - 16 - 17 - 18 19 - 20 - 21 - 22 24 - 27 - 30 - 32	2810	21

Yıldız İki Ağız Anahtar (mm)  
Double Ended Ring Wrench (mm)



TS 3794  
TS ISO 10104 Form B  
DIN 838

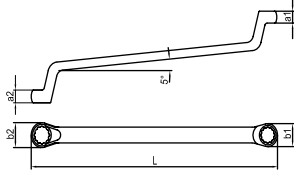

Krom vanadyum, Krom kaplı  
Chrom vanadium, Chrom plated

KOD CODE	mm	L mm	a1 mm	a2 mm	b1 mm	b2 mm	g		TL/Ad.
0450 03 0607	6x7	140	4.8	5.2	11	12	45	10	174,00
0450 03 0809	8x9	158	5.4	5.8	13.5	14.5	60	10	176,50
0450 03 1011	10x11	175	6	6.4	16	17.5	90	10	195,75
0450 03 1213	12x13	193	6.6	7.1	19	20	100	10	221,00
0450 03 1415	14x15	210	7.7	8.1	21.5	23.5	140	10	231,75
0450 03 1617	16x17	230	9.2	9.6	25.5	26.5	190	10	263,00
0450 03 1819	18x19	246	10.2	10.6	27.5	29.5	240	10	313,25
0450 03 2022	20x22	280	11.2	11.8	31	34	255	5	342,00
0450 03 2123	21x23	284	11.4	12.2	32.5	35	300	5	392,50
0450 03 2426	24x26	300	12.6	13.2	37	39	335	5	457,25
0450 03 2528	25x28	314	13.6	14.2	38	42	430	5	500,50
0450 03 2732	27x32	329	14.8	15.2	41	49	525	5	551,00

0450

Yıldız İki Ağız Anahtar Takımı (mm)  
Double Ended Ring Wrench Set (mm)

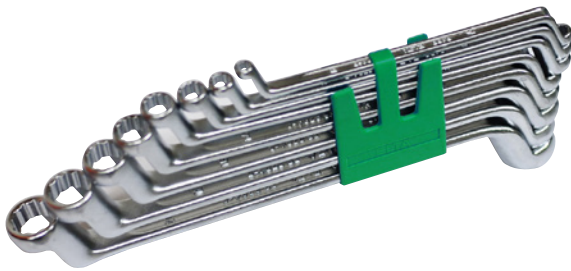

KOD CODE	İÇERİK CONTENTS	g		TL/Ad.
0450 00 2108	6x7 - 8x9 - 10x11 12x13 - 14x15 - 16x17 18x19 - 20x22	1120	8	1.917,25
0450 00 2112	6x7 - 8x9 - 10x11 12x13 - 14x15 - 16x17 18x19 - 20x22 - 21x23 24x26 - 25x28 - 27x32	2710	12	3.818,50

0601

Kurbağacık Anahtar  
Adjustable Wrench

TS ISO 6787

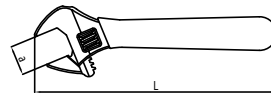

Özel alaşımlı çelik, Krom kaplı, PVC izoleli  
Special steel, Chrom plated, PVC Insulated

KOD CODE	L mm	L inch	a mm	g		TL/Ad.
0601 01 0008	206	8"	24	240	5	599,00
0601 01 0010	256	10"	27	400	5	900,00
0601 01 0012	306	12"	34	650	5	1.189,25



14000 005078

1/4" Cırcır Lokma Anahtar & Bits Set (38 parça, mm)  
Socket Wrench & Bits Set (38 Pcs, mm)

YENİ  
NEW



1/4"

KOD CODE	LOKMALAR Sockets	AVADANLIKLAR Accessories	g		TL/Ad.
14000 005078	5 - 5.5 - 6 - 7 - 8 9 - 10 - 11 - 12 13 - 14 Altı Köşe Lokma Anahtar Six Points	1/4" Cırcır kolu Ratchet Handle 1/4" Mafsal Universal Joint 1/4" Ara Kol Extension Bar 50 -100 mm 1/4" Derin Lokma Tornavida Adaptörü Spindle Handle SL3 - SL4 - SL5 SL6 PH1 - PH2 - PH3 PH4 PZ1 - PZ2 - PZ3 H3 - H4 - H5 - H6 T10 - T15 - T20 T25 - T27 - T30 T40	790	38	3.379,25

14000 005080

Adaptörlü Bits Uç Set (71 Parça, mm)  
Bits Set (71 Pcs)

YENİ  
NEW



KOD CODE	AVADANLIKLAR Accessories	g		TL/Ad.
14000 005080	Universal Bits Adaptörü Universal Bits Adapter Hızlı Değişirme Bits Adaptörü Quick Change Bits Adapter SL4 - SL6 (75 mm) SL4 - SL6 (25 mm) PH1 - PH2 - PH3 (75 mm) PH1 - PH2 - PH3 (25 mm) PZ1 - PZ2 (75 mm) PZ1 - PZ2 - PZ3 (25 mm) H2 - H2.5 - H3 - H4 - H5 H8 (25 mm) T20 - T25 (75mm) T10 - T15 - T20 - T25 - T27 T30 - T40 (25mm)	750	71	3.097,25

14000 005079

1/4" Cırcır Lokma Anahtar & Bits Set (23 parça, mm)  
Socket Wrench & Bits Set (23 Pcs)

YENİ  
NEW



1/4"

KOD CODE	LOKMALAR Sockets	AVADANLIKLAR Accessories	g		TL/Ad.
14000 005079	5 - 6 - 7 - 8 10 - 12 - 13 Altı Köşe Lokma Anahtar Six Points	1/4" Bits / Lokma Tutucu Cırcır Kolu 1/4" Ara Kol Extension Bar 50 mm Hızlı Değişirme Bits Adaptörü SL4 - SL6 PH1 - PH2 H4 - H5 - H6 T15 - T20 - T25 T27 - T30 - T40	425	23	3.379,25

Havali aletler ile kullanmayınız / Do not use with power-tools

**1/2" Altı Köşe Lokma Anahtar (mm)**  
 Socket Wrench 6 Points (mm)

 TS ISO 2725-1  
 DIN 3124

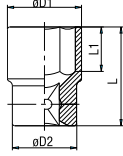
**1/2"**

 Krom vanadyum, Krom kaplı  
 Chrom vanadium, Chrom plated

KOD CODE	mm	σ D1 mm	σ D2 mm	L mm	L1 mm	g	TL/ Ad.
1115 06 0010	10	15.4	22	38	8	60	10
1115 06 0011	11	16.6	22	38	8	60	10
1115 06 0012	12	17.9	22	38	9	60	10
1115 06 0013	13	19	22	38	10	60	10
1115 06 0014	14	20.4	22	38	11	60	10
1115 06 0015	15	21.6	22	38	11	65	10
1115 06 0016	16	22.9	22	38	11	70	10
1115 06 0017	17	24.1	22	38	12	70	10
1115 06 0018	18	25.4	23	38	13	75	10
1115 06 0019	19	26.6	23	38	13	75	10
★ 1115 06 0020	20	28	24	38	13	80	10
1115 06 0021	21	29.2	24	38	13	80	5
1115 06 0022	22	30.4	26	38	15	95	5
1115 06 0023	23	31.2	28	38	15	100	5
1115 06 0024	24	33	28	38	17	115	5
1115 06 0026	26	34	30	42	17	130	5
1115 06 0027	27	36.6	30	42	19	140	5
1115 06 0028	28	37.5	30	42	20	160	5
1115 06 0030	30	40	32	44	21	175	5
1115 06 0032	32	43	34	44	23	180	5

**1514 06 4025**
**1/2" T Kol**  
 Sliding T - Handle

 TS ISO 3315  
 DIN 3122

**1/2"**

 Krom vanadyum, Krom kaplı  
 Chrom vanadium, Chrom plated

KOD CODE	L mm	g	TL/ Ad.
★1514 06 4025	250	370	5

Havalı aletler ile kullanmayınız / Do not use with power-tools

**1514 06 6250**
**1/2" T Kol Adaptörü**  
 Adapter

**1/2"**

 Krom vanadyum, Krom kaplı  
 Chrom vanadium, Chrom plated

KOD CODE	inch	g	TL/ Ad.
1514 06 6250	3/8"Fx1/2"M	90	5

**1514**
**1/2" Ara Kol**  
 Extension Bar

 TS ISO 1174-1  
 TS ISO 3316  
 DIN 3123

**1/2"**

 Krom vanadyum, Krom kaplı  
 Chrom vanadium, Chrom plated

KOD CODE	L mm	g	TL/ Ad.
1514 06 4125	125	220	5
1514 06 4250	250	425	5

**1514 06 4065**
**1/2" Mafsal**  
 Universal Joint

 TS ISO 3316  
 DIN 3123

**1/2"**

 Krom vanadyum, Krom kaplı  
 Chrom vanadium, Chrom plated

KOD CODE	L mm	g	TL/ Ad.
1514 06 4065	65	140	5

★ Stoklarla Sınırlıdır / It is Limited by Stocks.

1514 06 5250

1/2" Cırcır Kolu (32 Diş)  
Ratchet Handle (32 Teeth)

TS ISO 3315  
DIN 3122



1/2"

Krom vanadyum, Krom kaplı  
Chrom vanadium, Chrom plated

KOD CODE	L mm	g	□	TL/Ad.
1514 06 5250	250	585	5	1.041,75

1115 00 2017

1/2" Altı Köşe Lokma Anahtar Takımı (17 Parça, mm)  
Socket Wrench Set 6 Points (17 pcs, mm)

1115 00 2024

1/2" Altı Köşe Lokma Anahtar Takımı (24 Parça, mm)  
Socket Wrench Set 6 Points (24 pcs, mm)



1/2"

1/2"



1/2"

1/2"

KOD CODE	LOKMA LAR Sockets	AVADAN LIKLAR Accessories	g	□	TL/Ad.
1115 00 2017		1/2" Cırcır Kolu Ratchet Handle	2650	17	4.150,00
		1/2" T Kol Adaptör Sliding T Handle Adapter			
	10 - 11 - 12 13 - 14 - 15 17 - 19 - 22 24 - 27 - 30 32	1/2" Mafsal Universal Joint			
		1/2" Ara Kol Extension Bar 250 mm			

KOD CODE	LOKMA LAR Sockets	AVADAN LIKLAR Accessories	g	□	TL/Ad.
1115 00 2024		1/2" Cırcır Kolu Ratchet Handle	3485	24	5.392,50
		1/2" Mafsal Universal Joint			
	10 - 11 - 12 13 - 14 - 15 16 - 17 - 18 19 - 21 - 22 23 - 24 - 26 27 - 28 - 30 - 32	1/2" T Kol Adaptör Sliding T Handle Adapter			
		1/2" Ara Kol Extension Bar 125 mm			
		1/2" Ara Kol Extension Bar 250 mm			

Havali aletler ile kullanmayınız / Do not use with power-tools



**Maşalı Boru Anahtarı (85°)**  
Pipe Wrench (85°)

TS 3796  
DIN 5234

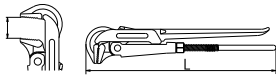

Krom vanadyum, Dişler induksiyonda sertleştirilmiş, Elektrostatik boyanmış  
Chrom vanadium, Teeth induction hardened, Electrostatically painted

KOD CODE	L mm	mm	inch	g		TL/Ad.
2203 10 0010	325	40	1"	760	1	1.025,00
2203 10 0015	430	60	1 1/2"	1360	1	1.609,25
2203 10 0020	585	70	2"	2350	1	2.397,75

**2401 11 0240**

**Fort Pense**  
Waterpump Pliers

TS 60  
TS ISO 8976  
DIN 8976

**2509 11 0225**

**Ayarlı Pense**  
Grip

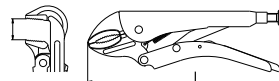
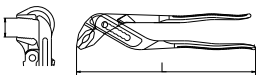

Nikel kaplı, PVC izoleli  
Nickel plated, PVC Insulated

Nikel kaplama, Kullanım sahası: Yuvarlak ve düz malzemeler  
Nickel plated, Application field: Flat and round materials

KOD CODE	L mm	L inch	mm	g		TL/Ad.
2401 11 0240	240	9 1/2"	35	375	5	968,50

KOD CODE	L mm	L inch	mm	g		TL/Ad.
2509 11 0225	225	9"	30	470	5	933,75

3021

**Kombine Pense Opak Seri**  
Combination Pliers

TS 60  
DIN ISO 5746



Özel alaşımli çelik, Kesici ağızlar indüksiyonda sertleştirilmiş, PVC saplı  
Special steel, Cutters induction hardened, PVC handle

KOD CODE	L mm	L inch	g	□	TL/Ad.
3021 12 1160	160	6 1/4"	200	5	500,50
3021 12 1180	180	7 1/8"	250	5	613,25
3021 12 1200	200	8"	310	5	746,50

3221

**Kargaburun Düz Uçlu Opak Seri**  
Long Nose Pliers (Flat)

TS 60  
TS ISO 5745



Özel alaşımli çelik, Kesici ağızlar indüksiyonda sertleştirilmiş, PVC saplı  
Special steel, Cutters induction hardened, PVC handle

KOD CODE	L mm	L inch	g	□	TL/Ad.
3221 13 1160	160	6 1/4"	145	5	543,75
3221 13 1200	200	8"	190	5	623,00

3701

**Yan Keski Opak Seri**  
Side Cutting Pliers

TS 60  
TS ISO 5749  
DIN 5749



Özel alaşımli çelik, Kesici ağızlar indüksiyonda sertleştirilmiş, PVC saplı  
Special steel, Cutters induction hardened, PVC handle

KOD CODE	L mm	L inch	g	□	TL/Ad.
3701 16 1140	140	5 1/2"	160	5	476,50
3701 16 1160	160	6 1/4"	220	5	559,25

3801

**Kerpeten**  
Carpenter Pincers

TS 60  
TS ISO 9243  
DIN ISO 9243



Özel alaşımli çelik, Kesici ağızlar indüksiyonda sertleştirilmiş, Vernikli, PVC izoleli  
Special steel, Cutters induction hardened, Lacquered, PVC Insulated

KOD CODE	L mm	L inch	g	□	TL/Ad.
3801 15 0160	160	6 1/4"	235	5	545,00
3801 15 0180	180	7 1/8"	245	5	588,00
3801 15 0200	200	8"	390	5	734,50

3832

**Betoncu Kerpeteni**  
Tower Pincers

TS 60  
TS ISO 9242  
DIN ISO 9242



Özel alaşımli çelik, Kesici ağızlar indüksiyonda sertleştirilmiş, Vernikli, PVC izoleli  
Special steel, Cutters induction hardened, Lacquered, PVC insulated

KOD CODE	L mm	L inch	g	□	TL/Ad.
3832 15 0225	225	9"	335	5	701,00
3832 15 0250	250	10"	415	5	798,00
3832 15 0280	280	11"	475	5	957,75

4170 17 0680

**Değişken Uçlu Tornavida**  
Screwdriver - Reversible

TSEK

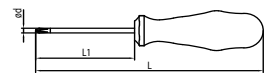

Krom vanadyum, Krom kaplı, PP saplı  
Chrom vanadium, Chrom plated, PP handle



KOD CODE	φDxL1 mm	axb mm	+	L mm	g	□	TL/Ad.
4170 17 0680	6x80	1.2x6	Ph2	180	60	10	205,25

**Opak Seri Düz Uçlu Tornavida**  
Screwdriver, Opak, Flat



TS ISO 2380 - 1  
DIN ISO 2380-1

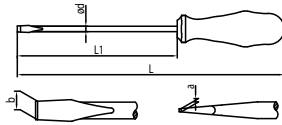

**Krom vanadyum, Krom kaplı, PP saplı**  
Chrom vanadium, Chrom plated, PP handle

KOD CODE	σDxL1 mm	-		L mm	g	□	TL/Ad.
		a mm	b mm				
4150 17 0380	3x80	0.5	3	150	20	10	90,00
4150 17 0480	4x80	0.8	4	170	30	10	103,25
4150 17 4100	4x100	0.8	4	190	40	10	110,50
4150 17 5100	5x100	1.0	5.5	200	55	10	132,00
4150 17 5125	5x125	1.0	5.5	225	60	10	152,50
4150 17 6100	6x100	1.2	6.5	200	70	10	138,00
4150 17 6125	6x125	1.2	6.5	225	75	10	156,00
4150 17 6150	6x150	1.2	6.5	250	80	10	173,00
4150 17 7150	7x150	1.2	8	260	110	10	201,75
★ 4150 17 8150	8x150	1.6	10	260	130	10	218,50
4150 17 8175	8x175	1.6	10	285	135	10	243,75

**Opak Seri Yıldız Uçlu Tornavida**  
Screwdriver, Opak Phillips



TS 59 - 5 ISO 8764  
DIN ISO 8764

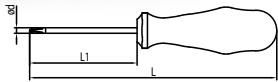

**Krom vanadyum, Krom kaplı, PP saplı**  
Chrom vanadium, Chrom plated, PP handle

KOD CODE	σDxL1 mm	+	L mm	g	□	TL/Ad.
4170 18 4580	4.5x80	Ph1	170	45	10	135,75
4170 18 6100	6x100	Ph2	200	70	10	163,25
4170 18 8150	8x150	Ph3	260	130	10	307,25

**Opak Seri Tornavida Seti (6 parça)**  
Screwdriver Set, Opak (6 Pcs)



KOD CODE	İÇERİK CONTENTS	g	□	TL/Ad.
4150 00 8106	4x80 - 5x100 - 6x125	545	6	892,00
	7x150			
	Düz uçlu / Flat 4.5x80 - 6x100 Yıldız uçlu / Phillips			

**Opak Seri Tornavida Seti (7 parça)**  
Screwdriver Set, Opak (7 Pcs)



KOD CODE	İÇERİK CONTENTS	g	□	TL/Ad.
4150 00 8107	3x80 - 4x100 - 5x125	605	7	1.068,75
	6x150 - 8x175			
	Düz uçlu / Flat 4.5x80 - 6x100 Yıldız uçlu / Phillips			

★ Stoklarla Sınırlıdır / It is Limited by Stocks.



## 4908

### Allen Anahtar Altı Köşe Standart Boy (mm) Hex Key Wrench Standard Size (mm)

TS ISO 2936  
DIN ISO 2936

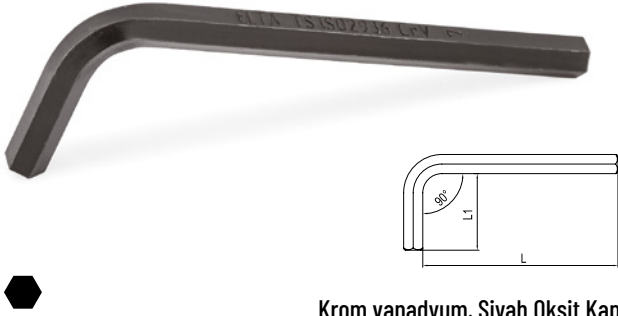

Krom vanadyum, Siyah Oksit Kaplı  
Chrom vanadium, Black finish

KOD CODE	mm	L mm	L1 mm	g	TL/Ad.	
4908 22 0015	1.5	45	14	1.5	10	13,25
4908 22 0020	2	50	16	2	10	17,00
4908 22 0025	2.5	56	18	4	10	19,25
4908 22 0030	3	63	20	6	10	21,75
4908 22 0035	3.5	66	22	8	10	25,25
4908 22 0040	4	70	25	10	10	29,00
4908 22 0050	5	80	28	20	10	30,00
4908 22 0060	6	90	32	30	10	41,00
4908 22 0070	7	95	36	40	10	57,75
4908 22 0080	8	100	36	55	10	66,00
4908 22 0090	9	105	38	75	10	93,75
4908 22 0100	10	112	40	100	10	101,00
4908 22 0120	12	125	45	160	10	146,50

## 4908

### Allen Anahtar Takım Altı Köşe Standart Boy (mm) Hex Key Wrench Set Standard Size (mm)

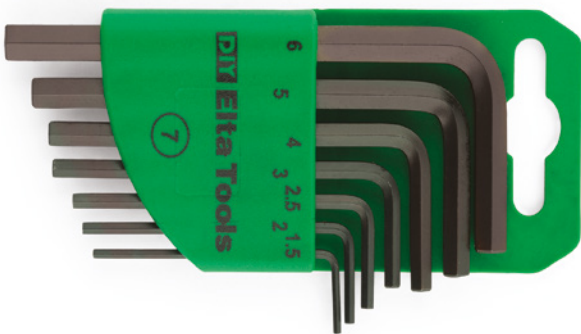

KOD CODE	İÇERİK CONTENTS	g	TL/Ad.	
4908 00 3107	1.5 - 2 - 2.5 - 3 - 4 - 5 - 6	80	7	171,25
4908 00 3109	1.5 - 2 - 2.5 - 3 - 4 - 5 - 6 - 8 - 10	235	9	338,25
4908 00 3110	1.5 - 2 - 2.5 - 3 - 4 - 5 - 6 - 8 - 10 - 12	395	10	484,75

## 4922

### T Tipi Allen Anahtar (mm) Hex Key Wrench T - Handle (mm)



Krom vanadyum, Siyah Oksit Kaplı, PP saplı  
Chrom vanadium, Black finish, PP handle

KOD CODE	mm	L mm	L1 mm	g	TL/Ad.	
4922 22 0025	2.5	110	14	15	5	164,50
4922 22 0030	3	125	18	20	5	164,50
4922 22 0040	4	140	22	30	5	167,00
4922 22 0050	5	155	26	55	5	188,50
4922 22 0060	6	170	30	75	5	206,50
4922 22 0070	7	185	34	115	5	213,75
4922 22 0080	8	200	38	150	5	258,00
4922 22 0100	10	220	48	270	5	449,00

## 4922 00 8108

### T Tipi Allen Anahtar Takımı (8 Parça, mm) Hex Key Wrench T - Handle Set (8 Pcs, mm)



KOD CODE	İÇERİK CONTENTS	g	TL/Ad.	
4922 00 8108	2.5 - 3 - 4 - 5 6 - 7 - 8 - 10	730	8	1.811,75

**Kaset Allen Anahtar Takımı (6 Parça, mm)**  
Hex Key Wrench Folding Set (6 Pcs, mm)



**Krom vanadyum, Siyah oksid kaplı**  
Chrom vanadium, Black finish

KOD CODE	İÇERİK CONTENTS	g	Ad.	TL/Ad.
4915 00 6106	2.5 - 3 - 4 - 5 - 6 - 8	175	1	801,75

**5011**

**Iskarpela (Düz)**  
Wood Chisel

TS 531

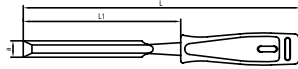

**Özel alaşımli çelik, Uç indüksiyonda sertleştirilmiş, PP Saplı**  
Special steel, induction hardened tips, PP Handle

KOD CODE	a mm	L mm	L1 mm	g	Ad.	TL/Ad.
5011 23 0006	6	240	120	105	5	302,50
5011 23 0008	8	242	122	125	5	321,75
5011 23 0010	10	244	124	140	5	339,75
5011 23 0012	12	246	126	140	5	372,00
5011 23 0014	14	248	128	145	5	385,25
5011 23 0016	16	250	130	165	5	411,75
5011 23 0018	18	252	132	165	5	446,50
5011 23 0020	20	254	134	165	5	494,50
5011 23 0022	22	256	136	180	5	537,75
5011 23 0024	24	258	138	205	5	579,75
5011 23 0026	26	260	140	205	5	601,25
5011 23 0030	30	264	144	205	5	642,00

**5801**

**Tesviyeci Çekiç**  
Machinist Hammer

TS 5-1  
DIN 1041

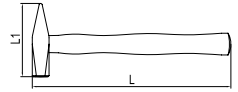

**Özel alaşımli çelik, İndüksiyonda sertleştirilmiş, Elektrostatik boyanmış**  
Special steel, Induction hardened, Electrostatically painted

KOD CODE	L mm	L1 mm	g	g	Ad.	TL/Ad.
5801 25 0500	320	118	500	600	5	310,50
5801 25 1000	360	135	1000	1095	5	500,25
5801 25 1500	380	145	1500	1630	5	603,75
5801 25 2000	400	155	2000	2100	5	690,00

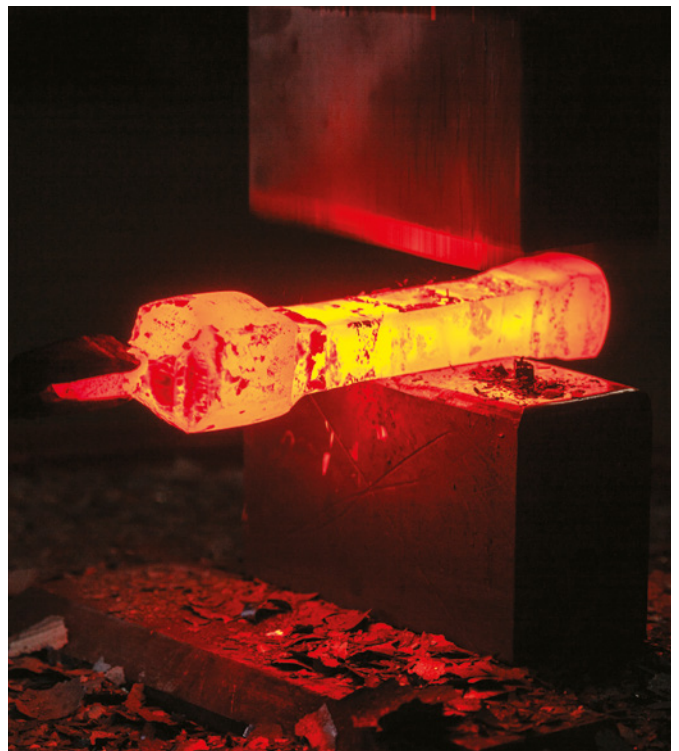

5884

Plastik Şerit Metre  
Plastic Measuring tapes



Plastik Şerit Metre  
Plastic Measuring tapes



KOD CODE	ÖLÇÜ SIZE	g		TL/Ad.
★ 5884 26 0003	3	95	5	138,00
★ 5884 26 0005	5	195	5	198,00

KOD CODE	ÖLÇÜ SIZE	g		TL/Ad.
14000 005370	3	95	5	136,00
14000 005369	5	195	5	196,00

14000 005508

Makaralı Uzatma Kablosu 5m (EI Tipi)  
Extension Cord Reel 5m (With Handle)

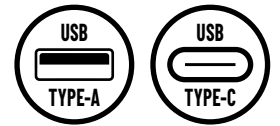

TEKNİK ÖZELLİKLER / TECHNICAL DATA

Nominal Gerilim / Nominal Voltage	230V- 50/60Hz
Akım / Current	Max. 16A
Kablo Sarılı Halde Maks. Güç / Load Reeled	1000W
Kablo Açılmış Halde Maks. Güç / Extended Max.	2300W
Soket Tipi / Socket Type	4x2 P + E
Soket Standardı / Socket Standart	Schuko (F-type)
Kablo / Cable	Max. ø 3x2.5mm
Giriş Koruması / Ingress Protection	IP44-IP20

KOD CODE	MODEL	ÖLÇÜ SIZE	g		TL/Ad.
14000 005508	EI Tipi / With Handle	5	-	1	1.125,00

★ Stoklarla Sınırlıdır / It is Limited by Stocks.



5891 26 0830

Testere Kolu  
Hacksaw Frame

DIN 6473



KOD CODE	L mm	g		TL/ Ad.
5891 26 0830	300	345	5	489,75

6351

Levye Oluklu  
Tyre Lever, Straight

TSEK



Krom vanadyum, Krom kaplı  
Chrom vanadium, Chrom plated

KOD CODE	L mm	L inch	g		TL/Ad.
6351 26 0400	400	16"	435	5	378,00
6351 26 0500	500	20"	680	5	553,25
6351 26 0600	600	24"	970	5	720,00

6731 27 0650

Çim Kesme Makası (Eğri Ağız)  
Grass Shears (Wave Edges)



KOD CODE	L mm	L inch	g		TL/Ad.
6731 27 0650	650	25 5/8"	1195	5	854,50

6730 27 0550

Çim Kesme Makası (Düz Ağız)  
Grass Shears (Straight)



KOD CODE	L mm	L inch	g		TL/Ad.
6730 27 0550	550	21 5/8"	915	5	1.526,50

6721 27 0205

**Bağ Makası (Lüks)**  
Pruning Shears (Lux)



Özel alaşımlı çelik, Kesici ağızlar indüksiyonda sertleştirilmiş, Daldırma  
PVC izoleli Special steel, Cutters induction hardened, PVC dipped

KOD CODE	L mm	L inch	g	TL/Ad.
6721 27 0205	205	8"	290	5 647,00

6722 27 0220

**Bağ Makası (Hafif Tip)**  
Pruning Shears (Light)



Alüminyum gövde, Daldırma PVC izoleli  
Aluminum forged body, PVC dipped

KOD CODE	L mm	L inch	g	TL/Ad.
6722 27 0220	220	8 5/8"	240	5 932,50

8011 31 6001

**Teşhir Panosu**  
Display

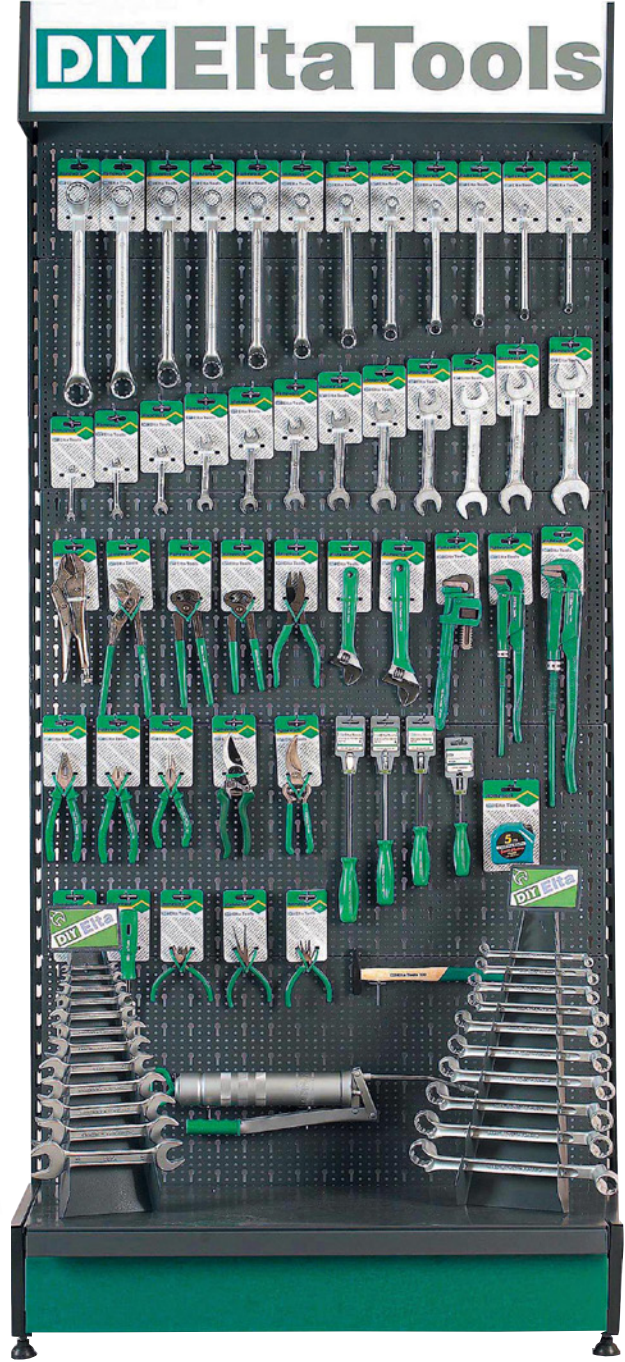

KOD CODE	SIZE mm	Cinsi	g	TL/Ad.
8011 31 6001	500x1000x2250	Boş	14000	1 10.799,00

14000 005043

**Metal Gövdeli Kilitli Maket Bıçağı 18mm**  
Metal-Bodied Safety Utility Knife 18mm



**Yedek parça sayfa 255-259**  
Spare parts page 255-259

- **Otomatik Kilit Mekanizması** / Auto-Lock Mechanism
- **Metal + ABS Plastik Gövde** / Metal-ABS Plastic Bodied
- **Ergonomik Yapı** / Ergonomic Design
- **18 mm Bıçak Genişliği** / 18 mm Blade Width
- **Bıçak Kırma Yeri** / Knife Breaking Part
- **Askı Delikli** / Hanging Hole

KOD/CODE	L mm	g	□	TL/Ad.
14000 005043	158	105	12	254,50

14000 005045

**Ergonomik Kilitli Maket Bıçağı 9mm**  
Ergonomic Safety Utility Knife 9mm



**Yedek parça sayfa 255-259**  
Spare parts page 255-259

- **Otomatik Kilit Mekanizması** / Auto-Lock Mechanism
- **ABS Plastik Gövde** / ABS Plastic Bodied
- **Kauçuk Kavramalı** / Rubber Coated
- **Ergonomik Yapı** / Ergonomic Design
- **9 mm Bıçak Genişliği** / 9 mm Blade Width
- **Bıçak Kırma Yeri** / Knife Breaking Part
- **Askı Delikli** / Hanging Hole

KOD/CODE	L mm	g	□	TL/Ad.
14000 005045	140	35	12	99,75

14000 005044

**Ergonomik Kilitli Maket Bıçağı 18mm**  
Ergonomic Safety Utility Knife 18mm



**Yedek parça sayfa 255-259**  
Spare parts page 255-259

- **Otomatik Kilit Mekanizması** / Auto-Lock Mechanism
- **ABS Plastik Gövde** / ABS Plastic Bodied
- **Kauçuk Kavramalı** / Rubber Coated
- **Ergonomik Yapı** / Ergonomic Design
- **18 mm Bıçak Genişliği** / 18 mm Blade Width
- **Bıçak Kırma Yeri** / Knife Breaking Part
- **Askı Delikli** / Hanging Hole

KOD/CODE	L mm	g	□	TL/Ad.
14000 005044	172	85	12	169,25

14000 005046

**Ergonomik Kilitli Maket Bıçağı Set 18mm - 9mm**  
Ergonomic Safety Utility Knife Set 18mm - 9mm



**Yedek parça sayfa 255-259**  
Spare parts page 255-259

- **Otomatik Kilit Mekanizması** / Auto-Lock Mechanism
- **ABS Plastik Gövde** / ABS Plastic Bodied
- **Kauçuk Kavramalı** / Rubber Coated
- **Ergonomik Yapı** / Ergonomic Design
- **9-18 mm Bıçak Genişliği** / 9-18 mm Blade Width
- **Bıçak Kırma Yeri** / Knife Breaking Part
- **Askı Delikli** / Hanging Hole

KOD/CODE	L mm	g	□	TL/Ad.
14000 005044	172	120	12	269,00
14000 005045	140			



**IZELTAS®**

# YEDEK PARÇALAR

SPARE PARTS



---



**Kurbağacak Anahtar ve Ayarlı Montaj Anahtarları Yedek Parçaları**  
 Adjustable Wrench, Spare Parts

	KOD CODE	L mm	L inch	g	TL/ Ad.
<b>Somun Nut</b> 	0600 01 0206	160	6"	5	10 53,00
	0600 01 0208	208	8"	10	10 62,50
	0600 01 0210	260	10"	10	10 83,00
	0600 01 0212	308	12"	20	10 114,00
	0600 01 0215	388	15"	65	10 163,25
<b>Vida Bolt</b> 	0600 01 0306	160	6"	3	10 14,50
	0600 01 0308	208	8"	5	10 21,75
	0600 01 0310	260	10"	5	10 26,50
	0600 01 0312	308	12"	10	10 33,75
	0600 01 0315	388	15"	20	10 42,00
<b>Yay Spring</b> 	0600 01 0406	160	6"	1	10 11,00
	0600 01 0408	208	8"	1	10 11,00
	0600 01 0410	260	10"	1	10 11,00
	0600 01 0412	308	12"	1	10 11,00
	0600 01 0415	388	15"	3	10 11,00

**Stilson Anahtar Yedek Parçaları**  
 Stillson Wrench Spare Part

	KOD CODE	ÖLÇÜ FOR	g	TL/ Ad.
<b>Çene Jaw</b> 	2100 10 0108	8"	80	5 367,25
	2100 10 0110	10"	180	5 543,75
	2100 10 0112	12"	320	5 606,00
	2100 10 0114	14"	400	5 731,00
	2100 10 0118	18"	575	5 983,00
	2100 10 0124	24"	980	5 1.406,50
	<b>Bağlantı Parçası Connection Part</b> 	2100 10 0208	8"	60
2100 10 0210		10"	95	5 835,25
2100 10 0212		12"	100	5 914,50
2100 10 0214		14"	195	5 1.103,00
2100 10 0218		18"	345	5 1.265,00
2100 10 0224		24"	445	5 1.890,00
<b>Somun Nut</b> 	2100 10 0308	8"	10	5 272,50
	2100 10 0310	10"	30	5 301,25
	2100 10 0312	12"	25	5 314,50
	2100 10 0314	14"	45	5 350,50
	2100 10 0318	18"	75	5 483,75
	2100 10 0324	24"	105	5 529,25

**Zincirli Boru Anahtarı Yedek Zinciri**  
 Spare Chain For Chain Pipe Wrench

KOD CODE	ÖLÇÜ SIZE Inch	L mm	g	TL/ Ad.
14000 005039	4"	555	840	1 2.421,75
14000 005038	6"	785	1635	1 4.224,00
14000 005139	8"	990	2400	1 4.927,25

**Ağır Tip Boru Anahtarı Yedek Parçaları**  
 Pipe Wrench, Heavy Duty Spare Parts

	KOD CODE	ÖLÇÜ FOR	g	TL/ Ad.	
<b>Çene Jaw</b> 	2110 10 0108	8"	100	5 810,00	
	2110 10 0110	10"	205	5 985,25	
	2110 10 0112	12"	235	5 1.943,00	
	2110 10 0114	14"	400	5 2.071,25	
	2110 10 0118	18"	675	5 2.201,00	
	2110 10 0124	24"	900	5 3.300,00	
	2110 10 0136	36"	1820	5 6.597,75	
	2110 10 0148	48"	3410	5 10.866,00	
	<b>Somun Nut</b> 	2110 10 0308	8"	10	5 267,75
		2110 10 0310	10"	25	5 281,00
2110 10 0312		12"	35	5 306,00	
2110 10 0314		14"	40	5 371,00	
2110 10 0318		18"	65	5 493,25	
2110 10 0324		24"	115	5 751,25	
2110 10 0336		36"	230	5 1.393,25	
2110 10 0348		48"	305	5 2.233,25	

**Alt Çene ve Pim**  
 Lower Jaw  
 and Pin

2110 10 0408	8"	15	5 853,25
2110 10 0410	10"	40	5 945,75
2110 10 0412	12"	60	5 1.065,75
2110 10 0414	14"	60	5 1.099,25
2110 10 0418	18"	90	5 1.139,00
2110 10 0424	24"	125	5 1.253,00
2110 10 0436	36"	225	5 1.997,00
2110 10 0448	48"	285	5 2.695,25

**Maşalı Boru Anahtarı Yedek Somun**  
 Nut

KOD CODE	ÖLÇÜ FOR	g	TL/ Ad.
2201 10 0110	1"	25	10 63,75
2201 10 0115	1 1/2"	40	10 80,50
2201 10 0120	2"	60	10 105,75
2201 10 0130	3"	75	10 141,75
2201 10 0140	4"	75	10 165,75

**Demir Kesme Makası Yedek**  
 Bolt Cutters Spare Part

**Çene  
Jaw**

KOD CODE	ÖLÇÜ SIZE	KAPASİTE CAPACITY ø mm	g	TL/ Ad.
2350 27 0118	18"	6 - 8	850	1 1.382,50
2350 27 0124	24"	8 - 10	870	1 1.584,00
2350 27 0130	30"	9 - 13	1250	1 2.802,00
2350 27 0136	36"	11 - 16	1850	1 5.173,25

**5850**
**Plastik Çekiç Yedek Başlık**  
 Plastic Hammer Spare Head

KOD CODE	ØD mm	g	TL/Ad.
5850 25 0130	30	35	10 132,00
5850 25 0140	40	70	10 187,25
5850 25 0150	50	120	10 267,75

**6400**
**Keser Yedek Sapı / Adze Handle**

KOD CODE	L mm	g	TL/Ad.
6400 25 0001	400	140	10 170,50

**5800**
**Tesviyeci Çekiç Yedek Sapı (Kamalı)**  
 Hammer Handle (With Pin)

KOD CODE	L mm	g	g	TL/Ad.
5800 25 0001	260	100	60	10 135,75
5800 25 0002	280	200	60	10 135,75
5800 25 0003	300	300	95	10 152,50
5800 25 0005	320	500	100	10 170,50
5800 25 0010	360	1000	165	10 221,00
5800 25 0015	380	1500	185	10 248,50
5800 25 0020	400	2000	205	10 267,75

**5865**
**Madırğa Yedek Sap (Kamalı)**  
 Mallet Handle (With Pin)

KOD CODE	L mm	g	TL/Ad.
5865 25 0001	260	1000	210 10 159,75
5865 25 0002	280	1500	270 10 175,25

**6410**
**Nacak Yedek Sap (Kamalı)**  
 Hatchet Handle (With Pin)

KOD CODE	L mm	g	g	TL/Ad.
6410 25 0001	380	800	250 10 512,50	

**03755**
**Kablo Sıyrıcı Yedek Bıçağı**  
 Cable Strippers Spare Blade

KOD CODE	ÖLÇÜ SIZE	g	TL/Ad.
03755 50 625	ø 4-16 / ø 8-28	25 5 187,25	

**06375**
**Ayarlı Yağ Filtresi Sökeceği Yedek Kelepçe**  
 Adjustable Slot Type Oil Filter Wrench Spare Clamp

KOD CODE	Ø mm	g	TL/Ad.
06375 50 010	65	20 5 152,50	





**6230**

Gres Pompası Yedek Ucu  
Grease Gun Nozzle



500cc  
300cc

KOD CODE	L mm	ø mm	g	TL/Ad.	
6230 26 2500	38	15	31	10	121,25

Hortumu  
Hose for  
Grease Gun



KOD CODE	ø mm	L mm	g	TL/Ad.	
6230 26 3300	8	300	34	10	138,00
6230 26 3500	12	500	102	10	253,25

**05898**

HSS Testere Laması  
Hacksaw Blade HSS



KOD CODE	ÖLÇÜ SIZE	g	TL/Ad.	
05898 50 283	13x0.65x18	20	100	129,75

**05899**

Bimetal Testere Laması  
Hacksaw Blade Bimetal



KOD CODE	ÖLÇÜ SIZE	g	TL/Ad.	
05899 50 283	13x0.65x18	20	100	151,25

**6735**

Dal Budama Testeresi Yedek Bıçak  
Spare Blade for Pruning Saw



KOD CODE	L mm	g	TL/Ad.	
6735 27 1300	300	60	5	1.129,25

**06765**

Plastik Boru Kesme Makası Bıçağı  
Plastic Pipe Cutter Spare Blade



KOD CODE	ÖLÇÜ SIZE	g	TL/Ad.	
06765 50 042	42	73	5	1.793,00
06765 50 063	63	105	5	3.329,00

**6850**

Mini Boru Kesici Bıçağı / Blade For Mini Tube Cutter  
Standart Boru Kesici Bıçağı / Blade For Standard Tube Cutter  
Teleskopik Boru Kesici Bıçağı / Blade For Telescopic Tube Cutter



KOD CODE	ÖLÇÜ SIZE	g	TL/Ad.	
6850 28 1322	1/4" - 1 3/8"	5	10	201,75

**6865**

Profesyonel Boru Kesici Bıçağı  
Blade For Professional Tube Cutter



KOD CODE	ÖLÇÜ SIZE	g	TL/Ad.	
6865 28 0150	1/8" - 2"	30	5	416,50

**14000 005090**

Pro Güvenlikli Trapez Maket Bıçağı Yedek Bıçak 18 mm  
Pro Safety Utility Knife Spare Blade 18 mm



KOD CODE	Ölçü / SIZE (mm)	TL/Ad.	
14000 005090	18	10	108,00

**14000 005088**

Pro Maket Bıçağı Yedek Bıçak 18 mm  
Pro Utility Knife Spare Blade 18 mm



KOD CODE	Ölçü / SIZE (mm)	TL/Ad.	
14000 005088	18	10	85,25

**14000 005089**

Pro Maket Bıçağı Yedek Bıçak 9 mm  
Pro Utility Knife Spare Blade 9 mm



KOD CODE	Ölçü / SIZE (mm)	TL/Ad.	
14000 005089	9	10	54,00

**14000 005091**

Pro Maket Bıçağı Yedek Bıçak 30° Açılı 9 mm  
Pro Utility Knife Spare Blade 30° 9 mm



KOD CODE	Ölçü / SIZE (mm)	TL/Ad.	
14000 005091	9	10	54,00

## 7010-7020

### Standart Çektirme Yedek Parçaları Spare Parts For Standard Pullers

#### Uzatma Parçası / Connection Part, Extension



KOD CODE	L mm	KULLANILAN ÇEKTİRME FOR	g	TL/Ad.
7010 29 2033	200	8x10 - 12x10	415	1 611,00
7010 29 3033	300	16x15 - 20x15	890	1 1.063,25
7010 29 4033	400	25x20 - 35x20 37x20 - 52x20	2350	1 1.572,00

#### Kol / Arm



KOD CODE	L mm	KULLANILAN ÇEKTİRME FOR	g	TL/Ad.
7010 29 0822	8x10 - 12x10	110	1	461,00
7010 29 1622	16x15 - 20x15	330	1	800,50
7010 29 2522	25x20 - 35x20 52x20 - 37x20	775	1	1.400,50

#### Bağlantı Parçası / Connection Part



KOD CODE	L mm	KULLANILAN ÇEKTİRME FOR	g	TL/Ad.
7010 29 0833	8x10 - 12x10	160	1	233,00
7010 29 1633	16x15 - 20x15	325	1	401,00
7010 29 2533	25x20 - 35x20 52x20 - 37x20	930	1	702,00

#### Mil / Spindle



KOD CODE	L mm	KULLANILAN ÇEKTİRME FOR	g	TL/Ad.
7010 29 0844	8x10 - 12x10	185	1	421,25
7010 29 1644	16x15 - 20x15	555	1	803,00
7010 29 2544	25x20	1400	1	1.380,00
7010 29 3544	35x20 - 37x20	2185	1	1.799,00
7010 29 5244	52x20	3210	1	1.799,00

## 7030-7040

### Master Çektirme Yedek Parçaları/Spare Parts For Master Puller

#### Kol / Arm



KOD CODE	KULLANILAN ÇEKTİRME FOR	g	TL/Ad.
7030 29 0822	8x8	110	1 252,00
7030 29 1222	12x12	215	1 349,25
7030 29 1622	16x16	345	1 623,00
7030 29 2322	23x20	580	1 847,25

#### Mil/Spindle



KOD CODE	L mm	KULLANILAN ÇEKTİRME FOR	g	TL/Ad.
7030 29 0844	8x8	180	1	342,00
7030 29 1244	12x12	360	1	503,00
7030 29 1644	16x16	680	1	555,75
7030 29 2344	23x20	1230	1	761,00

## 7050-7060

### Batarya Çektirme Yedek Parçaları Spare Parts For Battery Pullers

#### Kol / Arm



KOD CODE	KULLANILAN ÇEKTİRME FOR	g	TL/Ad.
7050 29 0422	6x4	40	1 197,00
7050 29 0622	6x6	50	1 219,75
7050 29 0822	8x8	110	1 252,00

#### Mil / Spindle



KOD CODE	KULLANILAN ÇEKTİRME FOR	g	TL/Ad.
7050 29 0444	6x4	95	1 291,75
7050 29 0644	6x6	105	1 326,50
7050 29 0844	8x8	200	1 410,50

## 7070-7080

### S Tipi Çektirme Yedek Parçaları Spare Parts For S Type Puller

#### Kol / Arm



KOD CODE	KULLANILAN ÇEKTİRME FOR	g	TL/Ad.
7070 29 2022	20x13	405	1 504,00

#### Mil / Spindle



KOD CODE	L mm	KULLANILAN ÇEKTİRME FOR	g	TL/Ad.
7070 29 2044	20x13	520	1	702,00

## 7090-7100

### Üniversal Çektirme Yedek Parçaları Spare Parts For Universal Puller

#### Kol / Arm



KOD CODE	KULLANILAN ÇEKTİRME FOR	g	TL/Ad.
7090 29 2322	22x22	690	1 560,50

#### Mil / Spindle



KOD CODE	L mm	KULLANILAN ÇEKTİRME FOR	g	TL/Ad.
7090 29 2244	22x22	565	1	739,25

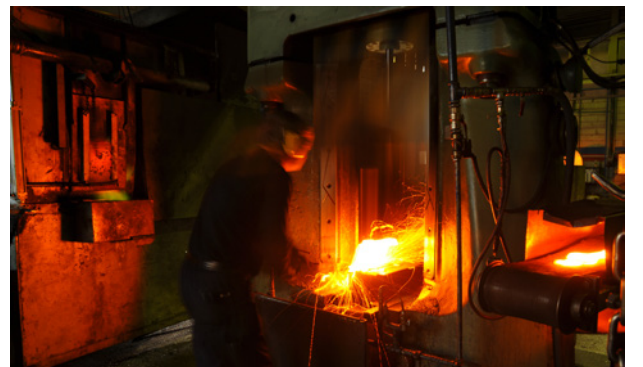







**IZELTAS®**

# TİCARİ TEŞHİR ÜRÜNLERİ

COMMERCIAL DISPLAY PRODUCTS



1113 31 6100

**1/2" Lokma Anahtar Sehpası**  
Display Frame for Sockets

1/2"

KOD CODE	ÖLÇÜ SIZE mm	g	TL/Ad.
1113 31 6100	175x360x605	5800	3.264,00

7010 31 6105

**Çektirme Sehpası**  
Display Frame For Pullers

KOD CODE	İÇERİK CONTENTS	g	TL/Ad.
7010 31 6105	Boş - Empty	2000	945,75

2350 31 6104

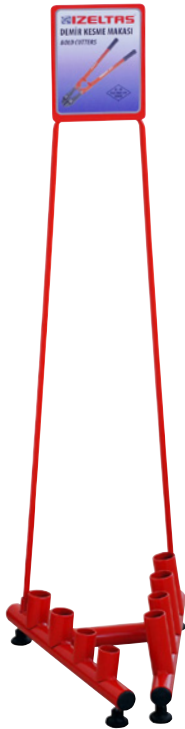
**Demir Kesme Makası Sehpası**  
Display Frame for Bolt Cutters

KOD CODE	İÇERİK CONTENTS	g	TL/Ad.
2350 31 6104	Boş - Empty	7400	4.500,00

7300 31 6150

**İşkence Sehpası**  
Display Frame for Screw Clamps

KOD CODE	ÖLÇÜ SIZE mm	g	TL/Ad.
7300 31 6150	100x520x1420	8000	3.867,75

8001-8002

**Çatal ve Yıldız Anahtar Sehpası**  
Display Frame For Wrenches



Sacdan imal edilmiş, Fırın boya  
Made from metal sheet, Electrostatic paint

KOD CODE	ÖLÇÜ SIZE mm	g	İÇERİK CONTENTS	TL/Ad.
8001 31 6012	160x500	800	Çatal / Open Jaw	1 503,00
8002 31 6012	170x560	1000	Yıldız / Ring	1 627,75

8004 31 6004

**Dövme Çelik Mengene Sehpası**  
Forged Steel Vice Frame



KOD CODE	İÇERİK CONTENTS	g	TL/Ad.
8004 31 6004	Boş - Empty	8000	1 4.795,25

8015 31 6001

**Tekerlekli Üçgen Teşhir Standı**  
Triangular Display Frame



Sacdan imal edilmiş, Fırın boya  
Made from metal sheet, Electrostatic paint

KOD CODE	ÖLÇÜ SIZE mm	g	TL/Ad.
8015 31 6001	520x1670	29500	1 6.799,25





İzeltas El Aletleri Teşhir Panosu, satış noktaları için özel olarak dizayn edilmiştir. Kolayca monte edilebilen 19 ana parçadan oluşan panonun derinliği 46 cm, genişliği 100 cm, yüksekliği 220 cm'dir.

Etkili görünümü ve tüm ürünleri bir arada sergileme özelliği yanında, perakende satışlarda seçme kolaylığı sağlaması bakımından da önem taşımaktadır.

İzeltas's Product Exhibition Board has been specially designed for selling points. These boards have been formed from easily mountable 19 main parts and have the dimensions as following, width 46 cm, length 100 cm and height 220 cm.

Board features an impressive looking and displays the products all together, which makes it easy to choose desired tools during retail selling activities.

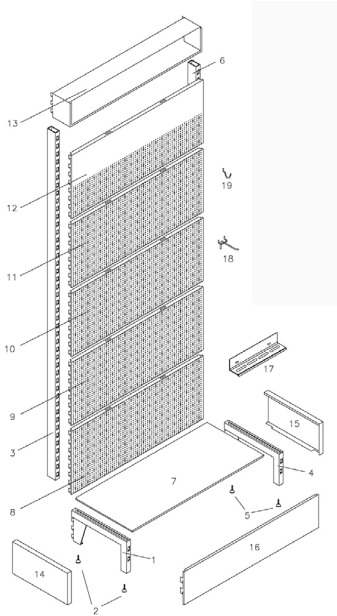

#### Montaj Sırası / Montage Order

1. Ayak / Stand right leg
2. Plastik ayak / Plastic leg
3. Kolon / Stand right column
4. Ayak / Stand left leg
5. Plastik ayak / Plastic leg
6. Kolon / Stand left column
7. Raf / Shelf
8. Delikli pano / Drilled panel
9. Delikli pano / Drilled panel
10. Delikli pano / Drilled panel
11. Delikli pano / Drilled panel
12. Yarım delikli pano / Half - drilled panel
13. Aydınlatma alınlığı / Illumination panel
14. Yan kapak / Side cover
15. Yan kapak / Side cover
16. Ön kapak / Front cover
17. Tornavida askısı / Screwdriver hanger
18. Büyük askı / Long hanger
19. Küçük askı / Short hanger

#### Büyük Pano Display Panel (Empty)

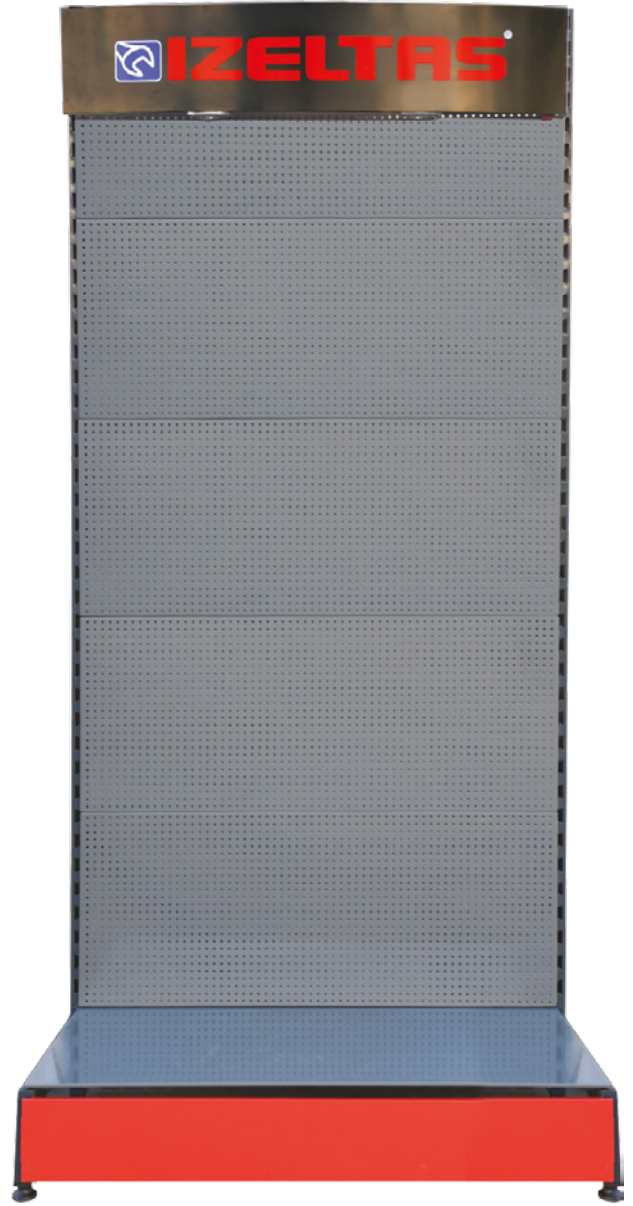

KOD CODE	ÖLÇÜ SIZE mm	Cinsi	g	TL/Ad.
8010 31 6001	460x1000x2200	Boş/Empty	43000	1 13.047,75

**IZELTAS®**

# TEKNİK BİLGİLER

TECHNICAL INFORMATION

---



## İş Güvenliği ve El Aletlerinin Yanlış Kullanımı



**Elektrik akımı geçme (1000V üzeri hariç) ihtimali olan tüm yerlerde IEC 60900'a göre izoleli uygun el aletleri kullanılmalıdır.**  
Hand tools with IEC 60900 compliant isolation must be used for any work involving risk of electrical current (excluding 1000V and above).



**Tozlu ve çapaklı alanlarda mutlaka gözlük kullanınız.**  
Make sure to wear goggles in work areas with dust and burrs.



**Lokma anahtarlarınızı uygun ölçülerdeki cıvata da, en geniş yüzeyde dik olarak kullanınız.** Lokma anahtarların cıvataya eğik olarak takılıp kullanılması, kavrama yüzeyini azaltarak ürünün kullanım ömrünü kısaltacaktır.  
Use box wrenches with bolts of appropriate size, placed perpendicularly on the largest area of contact. Use of a box wrench at an angle will reduce the gripping surface and result in a shorter useful life.



**Yüksek sesli ortamlarda mutlaka kulaklık kullanınız.**  
Make sure to wear ear protection in work areas with high levels of noise.



**Çekici amacı dışında kendinden daha sert malzemelere vurmuyunuz, eğik olarak kullanmayınız.** Mantarlaşmış bölgeleri mutlaka temizleyerek kullanınız.  
Do not use a hammer outside its intended purpose or to hit objects harder than the hammer. Do not hit at an angle. Make sure to clean weakened parts before use.



**Kimyasal madde içeren işlerde mutlaka eldiven ve maske kullanınız.**  
Make sure to wear gloves and facemask for works involving chemical materials.

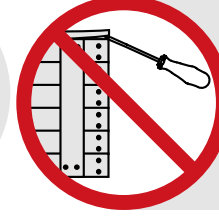

**Tornavidayı amacı dışında sökme işlemlerinde kullanmayınız.**  
Do not use the screwdriver as a levering tool out of its intended purpose.



**Anahtarlarınızı, ağız ölçüsüne uygun cıvatalarda kullanınız.** Anahtar ve cıvata arasındaki ölçü uyumsuzluğu, üründe ağız aşınmasına neden olur.  
Use wrenches with bolts of appropriate size. Size discrepancy between wrench and bolt will lead to wear on tool edge.



**Tornavidayı amacı dışında keski gibi ya da darbeli olarak kullanmayınız.**  
Do not use the screwdriver as a chiselling tool or for impacting out of its intended purpose.



**Anahtarların ağızına taşlama işlemi yapmayınız; sert cisimler sürterek müdahale etmeyiniz.** Bu durum anahtarınızın ağız yapısını bozar.  
Do not grind or expose the edge of wrenches to hard objects. This will deform the tool edge structure.



**Dolapları çekerek değil iterek kullanınız.**  
Do not pull the set cabinets. Push to move the cabinets.



**Anahtar gövdesine boru takarak kuvvet uygulamayınız.** Anahtarınızın ağız yapısının bozulmasına, kırılmalara ve yaralanmalara neden olabilir.  
Do not apply force to the wrench by attaching a pipe to the tool body. This may result in deformation of tool edge, breakage or injury.



**Dolapların birden fazla çekmecesini aynı anda açık bırakmayınız.** Ağırılık merkezi değişerek dolabın devrilmesine neden olacaktır.  
Do not leave multiple drawers of set cabinets open at the same time. This will move the centre of gravity and cause toppling.



**Anahtar gövdesine çekiç ile darbe uygulamayınız.** Ağız yapısında bozulmalara, kırılma ve yaralanmalara neden olabilir.  
Do not hit the wrench body with a hammer. This may result in deformation of tool edge, breakage or injury.



**Dolapların çekmecelerini ayağınızla kapatmaya ya da basamak, merdiven olarak kullanmaya çalışmayınız.** Bu gibi durumlar yaralanmalara sebep olacaktır.  
Do not use your foot to close a cabinet drawer or attempt to use cabinet drawers as a stepladder. Such actions will result in injury.



## TEKNİK BİLGİLER / TECHNICAL DATA

### ANAHTAR AĞZI ÖLÇÜLERİ VE VİDA ÇAPLARI SPANNER JAW WIDTH ACCROSS FLATS and THREAD DIAMETERS

mm	DIN ISO 272 ye göre metrik	DIN ISO 272 ye göre metrik	AF	Ağız Genişliği		Whitw.	BS 916 1083	Ağız Genişliği	
				inch	mm			inch	mm
4	2		5/32	0,1562	3,97	8 BA		0,152	3,86
4,5	2,3					7 BA		0,172	4,87
5	2,5		3/16	0,1875	4,76	6 BA		0,193	4,90
5,5	3,5		7/32	0,2187	5,56	5 BA		0,220	5,59
6	26,8		1/4	0,2500	6,35	4 BA		0,248	6,30
						1/16 W		0,256	6,50
7	4		9/32	0,2812	7,14	3 BA		0,282	7,16
						3/32 W		0,297	7,54
7-8	5		5/16	0,3125	7,94	2 BA		0,324	8,23
9	5 Alt		11/32	0,3438	8,73	1/8 W	(3/16)	0,340	8,64
			3/8	0,3750	9,52	1 BA		0,365	9,27
8-10	6		13/32	0,4062	10,32	0 BA	(7/32)	0,413	10,49
11	7		7/16	0,4375	11,11	3/16 W	1/4	0,445	11,30
12									
10-13	8		1/2	0,5000	12,70	1/4 W	5/16	0,525	13,34
14*	8 Alt		9/16	0,5625	14,29				
15	10 KFZ		19/32	0,5938	15,08	5/16 W	3/8	0,600	15,24
16	10		5/8	0,6250	15,88				
13-15-17	10		11/16	0,6875	17,46				
18	12					3/8 W	7/16	0,710	18,03
15-18-19	12		3/4	0,7500	19,05				
20*			25/32	0,7812	19,84				
18-21	14		13/16	0,8125	20,64	7/16 W	1/2	0,820	20,83
22-24	14	12	7/8	0,8750	22,22				
23*						1/2 W	9/16	0,920	23,37
21-24*	16		15/16	0,9375	23,81				
25*-27*		1,		1,0000	25,40				
26*						9/16 W	5/8	1,010	25,65
27	18	16	1.1/16	1,0625	26,99				
27-28*-30						5/8 W	(11/16)	1,100	27,94
			1.1/8	1,1250	28,58				
27-30-34	20		1.3/16	1,1875	30,16	11/16 W	3/4	1,200	30,48
32-36-41	22	20	1.1/4	1,2500	31,75				
			1.5/16	1,3125	33,34	3/4 W	7/8	1,300	33,02
34	22		1.3/8	1,3750	34,92	13/16 W	(15/16)	1,390	35,31
36-41	24		1.7/16	1,4375	36,51				
38*			1.1/2	1,5000	38,10	7/8 W	1	1,480	37,59
41-46	27	24	1.5/8	1,6250	41,28				
			1.11/16	1,6875	42,86	1. W	1.1/8	1,670	42,42
			1.3/4	1,7500	44,45				
46-50	30	27	1.13/16	1,8125	46,04				
			1.7/8	1,8750	47,62	1.1/8 W	1.1/4	1,860	47,24
50-55	33	30	2,	2,0000	50,80				
			2.1/16	2,0625	52,39	1.1/4 W	1.3/8	2,050	52,07
55-60	36		2.3/16	2,1875	55,56				
			2.1/4	2,2500	57,15	1.3/8 W	1.1/2	2,220	56,39
60-65	39	36	2.3/8	2,3750	60,32				
			2.7/16	2,4375	61,91	1.1/2 W	1.5/8	2,410	61,21
65	42		2.9/16	2,5625	65,09	1.5/8	1.3/4	2,580	65,53
			2.5/8	2,6250	66,68				
70	45		2.3/4	2,7500	69,85	1.3/4 W	2,	2,760	70,10
			2.13/16	2,8125	71,44				
75	48		2.15/16	2,9375	74,61				
			3,	3,0000	76,20	(1.7/8 W)			76,70
80	52		3.1/8	3,1250	79,38	2. W	2.1/4	3,150	80,01
85	56		3.3/8	3,3750	85,72				
90	60		3.1/2	3,5000	88,90		2.1/2	3,550	90,17
95	64		3.3/4	3,7500	92,25				
			3.7/8	3,8750	98,42		2.3/4	3,890	98,81
100	68								
105	72		4.1/8	4,1250	104,78		3,	4,180	106,17
110	76		4.1/4	4,2500	107,95				
115*	80		4.1/2	4,5000	114,30		3.1/4	4,530	115,06

### ANAHTAR İÇİN MİNİMUM DÖNDÜRME MOMENTLERİ TEST TORQUE VALUES FOR SPANNERS ISO 1711-1

	0430 0320 0330 0370	0440	0100 0130	1800	1870 1874
4			1,90		
4,5*			2,64		
5			3,55		
5,5			4,64		
6*	17,6	7,4	5,92	17,6	
7	25,2	11,4	9,12	25,2	
8	34,5	16,6	13,3	34,5	34,5
9*	45,5	23,0	18,4	45,5	45,5
10	58,1	31,0	24,8	58,1	58,1
11	72,7	40,4	32,3	72,7	72,7
12	89,1	51,5	41,2	89,1	89,1
13	107	64,5	51,6	107	107
14*	128	79,4	63,5	128	128
15	150	96,2	77,0	150	150
16	175	115	92,3	175	175
17	201	134	107	201	201
18	230	160	128	230	230
19*	261	186	149	261	261
20*	294	215	172	294	294
21	330	247	198	330	330
22*	368	281	225	368	368
23*	408	319	255	408	408
24	451	359	287	451	451
25*	496	402	322	496	496
26*	544	449	359	544	544
27	594	499	399	594	594
28*	647	552	442	647	647
30	760	670	536	760	760
32*	884	804	643	884	884
34	1019	951	761	1019	1019
36	1165	1117	994	1165	1165
41	1579	1442	1154	1579	1579
46	2067	1816	1453	2067	2067
50	2512	2145	1716	2512	2512
55	3140		2077	3140	3140
60	3849		2471	3849	
65	4021				
70	4658				
75	5394				



**VİDA AĞIZ ÖLÇÜLERİ**
**GUIDELINE FOR SCREWDRIVERS**

											
"Metrik Vida Metric screw"	<b>M 1.6</b> <b>(M 1.7)</b>	<b>M 2</b>	<b>M 2.3</b>	<b>(M 2.3)</b> <b>(M 2.6)</b>	<b>M 3</b>	<b>(M 3.5)</b>	<b>M 4</b>	<b>M 5</b>	<b>M 6</b>	<b>M 8</b>	<b>M 10</b>
Düz başlı Vidalar Flat head screws	0.4 x 3 (3.2)	0.5 x 3.8	0.6 x 4.4	0.6 x 4.5 (5)	0.8 x 5.5	0.8 x 6	1 x 7	1.2 x 8.5	1.6 x 10	2 x 13	2.5 x 16
Düz başlı Vidalar Flat head screws	—	—	—	—	0.8 x 6	0.8 x 7	1 x 8	1.2 x 10	1.6 x 12	2 x 16	2.5 x 20
Düz başlı Vidalar (küçük) Flat head screws (small sizes)	—	—	—	0.4 x 3.5	0.5 x 4	0.5 x 4.5	0.6 x 5.5	0.8 x 6.5	1 x 8	1.2 x 10	1.6 x 13
Oval başlı Vidalar Oval head screws	0.4 x 3	0.5 x 3.8	—	0.6 x 4.7	0.8 x 5.6	—	—	—	—	—	—
Havşa başlı Vidalar Countersank head screws	0.4 x 3	0.5 x 3.8	—	0.6 x 4.7	0.8 x 5.6	0.8 x 6.5	1 x 7.5	1.2 x 9.2	1.6 x 11	2 x 14.5	2.5 x 18

**YILDIZ VİDALAR İÇİN UYGUN TORNAVİDA AĞIZ ÖLÇÜLERİ**
**SUITABLE TIPS FOR CROSS HEAD SCREWS**



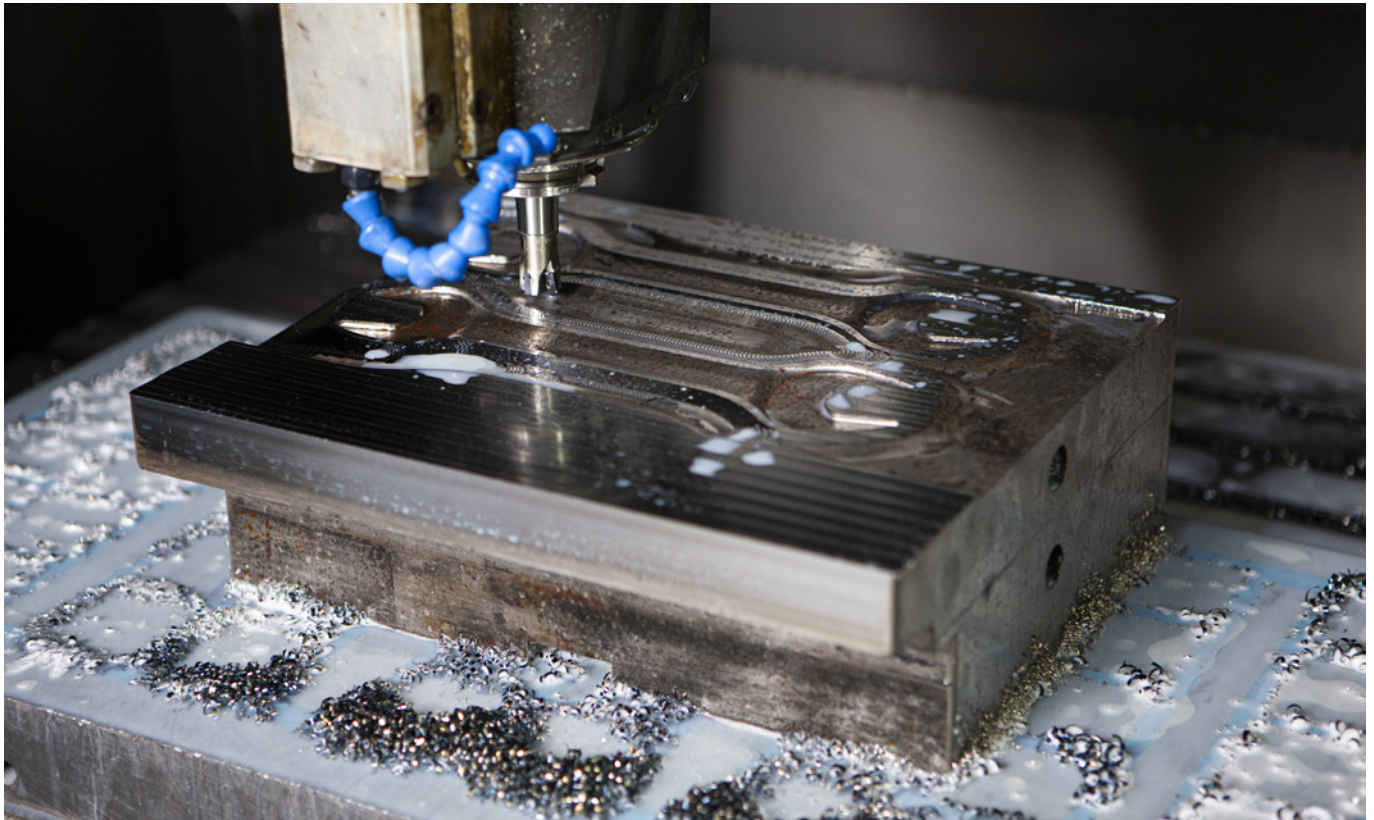

		
	Yıldız Ağız Ölçüsü Cross Slot Size	Metrik Vidalar Metric Screw
	0	M 1.6 - M 2
	1	M 2 - M 2.5 - M 3
	2	M 3.5 - M 5
	3	M 6
	4	M 8 - M 10



## TEKNİK BİLGİLER / TECHNICAL DATA

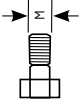
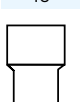

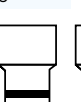



### METRİK VİDALAR İÇİN LOKMA SEÇİMİ

GUIDE TO METRIC SIZES COVERED BY SOCKET  
WRENCHES FOR EACH DRIVE

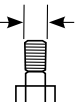
	1107 6.3	1110 10	1113 12.5	1119 20	1125 25
					
	1/4"	3/8"	1/2"	3/4"	1"
M 2	4				
	4,5				
M 2.5	5				
M 3	5,5				
M 3.5	6	6			
M 4	7	7			
M 5	8	8	8		
	9	9	9		
M 6	10	10	10	10	
M 7	11	11	11	11	
	12	12	12	12	
M 8	13	13	13	13	
		14	14	14	
		15	15	15	
M 10		16	16	16	
M 10		17	17	17	17
M 12		18	18	18	18
M 12		19	19	19	19
		20	20		
M 14		21	21	21	
M 14		22	22	22	22
		23	23		
M 16			24	24	24
			25		
			26		
M 18			27	27	27
			28		
M 20			30	30	30
M 22			32	32	32
			33	33	33
M 22			34	34	34
M 24			36	36	36
			38	38	38
M 27			41	41	41
				42	
M 30				46	46
M 33				50	50
M 36				55	55
M 39				60	60
M 42					65
M 45					70
M 48					75
M 52					

### LOKMA İÇİN MİN DÖNDÜRME MOMENTLERİ

TEST TORQUE VALUES FOR SOCKET  
ISO 1711-1(N-m)

		6,3 1107	10 1110	12,5 1113 1114	20 1119 1120	25 1125
						
		1/4"	3/8"	1/2"	3/4"	1"
M2	4	10,4				
M 2.2	4,5*	12,6				
M 2.5	5	15,1				
M 3	5,5	17,8				
M 3.5	6*	20,6	23,2			
M 4	7	26,8	33,2			
M 5	8	33,6	45,5	94,1		
	9*	41,1	59,9	119,2		
M 6	10	49,1	76,7	147		
M 7	11	57,8	96	178		
	12	67,0	118	212		
M 8	13	68,6	141	249		
	14*	68,6	169	288		
	15		198	331		
	16		225	377		
M 10	17		225	425		
	18		225	477		
M 12	19*		225	531		
	20*		225	569		
	21		225	569	-	
M 14	22*		225	569	569	
	23*			569	569	
M 16	24			569	569	
	25*			569	583	
	26*			569	624	
M 18	27			569	665	
	28*			569	707	
M 20	30			569	795	
M 22	32*			569	888	
	34			569	984	
M 24	36				1084	1677
M 27	41				1353	1910
M 30	46				1569	2143
M 33	50				1569	2329
M 36	55				1569	2562
M 39	60				1569	2795
M 42	65					2795
M 45	70					2795
M 48	75					2795
M 52	80					2795





# SIKMA / TEST TORK DEĞERLERİ TIGHTENING / TEST TORQUE VALUES

Önerilen (Bağlayıcı olmayan) cıvata sıkma torkları Nm (Newton Metre)  
Suggested (Not Compulsory) Bolt Tightening Torque in Nm (Newton Meter)

**Kalite Sınıfı DIN 267'ye Göre Sıkma Değerleri**  
Tightening Torques Values According to Quality Class DIN 267

	<b>4.6</b>	<b>5.6</b>	<b>6.9</b>	<b>8.8</b>	<b>10.9</b>	<b>12.9</b>
<b>M 2</b>	0,123	0,162	0,314	0,373	0,520	0,628
<b>M 2,2</b>	0,196	0,265	0,510	0,598	0,843	1,010
<b>M 2,5</b>	0,284	0,373	0,726	0,863	1,206	1,451
<b>M 3</b>	0,441	0,588	1,128	1,344	1,883	2,256
<b>M 3,5</b>	0,677	0,902	1,736	2,060	2,893	3,481
<b>M 4</b>	1,000	1,344	2,599	3,040	4,315	5,148
<b>M 5</b>	1,916	2,648	5,099	6,031	8,483	10,200
<b>M 6</b>	3,432	4,511	8,728	10,300	14,710	17,652
<b>M 7</b>	5,590	7,453	14,220	17,162	24,517	28,439
<b>M 8</b>	8,238	10,787	21,575	25,497	35,304	42,168
<b>M 10</b>	16,67	21,575	42,168	50,014	70,608	85,317
<b>M 12</b>	28,44	38,246	73,550	87,279	122,60	147,10
<b>M 14</b>	45,11	60,801	116,70	138,30	194,20	235,40
<b>M 16</b>	69,63	93,163	178,5	210,80	299,10	357,90
<b>M 18</b>	95,12	127,50	245,20	289,3	411,90	490,30
<b>M 20</b>	135,3	180,45	384,10	411,90	578,60	696,30
<b>M 22</b>	182,4	245,16	470,70	559,00	784,50	941,40
<b>M 24</b>	230,5	308,91	598,20	711,00	1000	1196
<b>M 27</b>	343,2	460,90	887,50	1049	1481	1775
<b>M 30</b>	465,8	622,72	1206	1422	2010	2403
<b>M 33</b>	632,5	848,30	1628	1932	2716	3266
<b>M 36</b>	814,0	1089	2099	2481	3491	4197
<b>M 39</b>	1059	1412	2716	3226	4531	5443
<b>M 42</b>	1304	1746	3364	3991	5609	6727
<b>M 45</b>	1638	2177	4207	4992	7012	8414
<b>M 48</b>	1981	2638	5080	6021	8473	10150
<b>M 52</b>	2540	3393	6541	7747	10885	13092
<b>M 56</b>	3168	4227	8149	9650	13582	16279
<b>M 60</b>	3932	5247	10101	11964	16867	20202
<b>M 64</b>	4737	6306	12160	14416	20300	24320

**Moment Değerleri Yağlanmış Cıvatalar İçin %20 Azaltılmalıdır.**  
*Torque Values Should be Decreased of 20% for Lubricated Screws*

## Ölçü Birimleri

### Measuring Units

Giga	G	1.000.000.000	=10 <sup>9</sup>	1GW= 1 Milyar Watt
Mega	M	1.000.000	=10 <sup>6</sup>	1 MW= 1 Milyon Watt
Kilo	k	1.000	=10 <sup>3</sup>	1 kW= Bin Watt
Milli	m	0.001	=10 <sup>-3</sup>	1 mm= Binde Bir Watt
Mikro	m	0.000001	=10 <sup>-6</sup>	1 mm= 1 Milyonda Bir Watt
Nano	n	0.000000001	=10 <sup>-9</sup>	1 nm= 1 Milyarda Bir Watt

## Önemli Ölçülerin Değişim Tablosu

### Conversion Table For Essential Measuring Units

Uzunluk Length	Metre	m		
Kütle Weight	Kilogram	kg		
Zaman Time	Saniye	s		
Kuvvet Force	Newton	N	=kg m/s <sup>2</sup>	1 N= 0.102 kp
Döndürme Mom. Torque	Newtonmetre			9.81 Nm= 1kpm
İş Enerjisi Work	Joule	J	=Nm	
Isı Enerjisi Heat	Joule	J		1 J= 0.239 cal
Güç Power	Watt	W	=Nm/s	1 kW= 1.36 PS=860 kcal/h
Basınç Pressure	Pascal	Pa	=N/m <sup>2</sup>	100.000 Pa=1 bar=10 mWS
Elektrik Akımı Electricity Current	Amper	A		
Sıcaklık Temperature	Kelvin	K		1K= -272.15 °C

## Döndürme Momenti Dönüşüm Tablosu

### Conversion Table For Bending Moments

Var Olan Ölçüler / present units	İstenen Ölçüler / Wanted Units					
	=Ncm	=Nm	=kpcm	=kpm	=lbf.in.	=lbf.ft.
Ncm	1	0.01	0.10197	0.00102	0.0885	0.00738
Nm	100	1	10.197	0.10197	8.851	0.7376
kpcm	9.807	0.09807	1	0.01	0.868	0.0723
kpm	980.07	9.807	100	1	86.796	7.233
lbf.in.	11.298	0.11298	1.152	0.01152	1	0.0833
lbf.ft.	135.58	1.3558	13.825	0.13825	12	1

## Newton-Metre ve Librefoot Dönüşüm Tablosu

### Conversion Table Of Newton-Meter And Librefoot (1 Nm=0.738 lbf.ft.)

Nm	ft.,lbs.									
	0	1	2	3	4	5	6	7	8	9
0	0	0.74	1.48	2.21	2.95	3.69	4.43	5.17	5.90	6.64
10	7.38	8.12	8.86	9.59	10.33	11.07	11.81	12.54	13.28	14.02
20	14.76	15.50	16.2	16.97	17.71	18.45	19.19	19.93	20.65	21.40
30	22.14	22.88	23.62	24.35	25.10	25.83	26.57	27.31	28.04	28.78
40	29.52	30.26	31.00	31.73	32.47	33.21	33.95	34.69	35.42	36.16
50	36.90	37.64	38.38	39.11	39.85	40.59	41.33	42.07	42.80	43.54
60	44.28	45.02	45.76	46.49	47.23	47.97	48.71	49.45	50.18	50.92
70	51.66	52.40	53.14	53.87	54.61	55.35	56.09	56.83	57.56	58.30
80	59.04	59.78	60.52	61.25	62.00	62.73	63.47	64.21	64.94	65.68
90	66.42	67.16	67.90	68.63	69.37	70.11	70.85	71.59	72.32	73.06
100	73.80	74.54	75.28	76.01	76.75	77.49	78.23	78.97	79.70	80.44

## Librefoot ve Newton-Metre Dönüşüm Tablosu

### Conversion Table Of Librefoot And Newton-Meter (1 lbf.ft.=1.356 Nm)

ft.-lbs.	Nm									
	0	1	2	3	4	5	6	7	8	9
0	0	1.36	2.71	4.07	5.42	6.78	8.14	9.49	10.85	12.20
10	13.56	14.92	16.27	17.63	18.98	20.34	21.70	23.05	24.41	25.76
20	27.12	28.48	29.83	31.19	32.54	33.90	35.26	36.61	37.97	39.32
30	40.68	42.04	43.39	44.75	46.10	47.46	48.82	50.17	51.53	52.88
40	54.24	55.60	56.95	58.31	59.66	61.02	62.38	63.73	65.09	66.44
50	67.80	69.16	70.51	71.87	73.22	74.58	75.94	77.29	78.65	80.00
60	81.36	82.72	84.07	85.43	86.78	88.14	89.50	90.85	92.21	93.56
70	94.92	96.28	97.63	98.99	100.34	101.70	103.06	104.41	105.77	107.12
80	108.48	109.84	111.19	112.55	113.90	115.26	116.62	117.97	119.33	120.68
90	122.04	123.40	124.75	126.11	127.46	128.82	130.18	131.53	132.89	134.24
100	135.60	136.96	138.31	139.67	141.02	142.38	143.74	145.09	146.45	147.80

## Newton-Metre ve Kilopound-Metre Dönüşüm Tablosu

### Conversion Table Of Newton-Meter and Kilopound-Meter (1 Nm=0.102 kpm)

Nm	kpm									
	0	1	2	3	4	5	6	7	8	9
0	0.00	1.02	2.04	3.06	4.08	5.10	6.12	7.14	8.16	9.18
100	10.20	11.22	12.24	13.26	14.28	15.30	16.31	17.33	18.35	19.37
200	20.39	21.41	22.43	23.45	24.47	25.49	26.51	27.53	28.55	29.57
300	30.59	31.61	32.63	33.65	34.67	35.69	36.71	37.73	38.75	39.77
400	40.79	41.81	42.83	43.85	44.87	45.89	46.91	47.93	48.95	49.97
500	50.99	52.01	53.02	54.04	55.06	56.08	57.10	58.12	59.14	60.16
600	61.18	62.20	63.22	64.24	65.26	66.28	67.30	68.32	69.34	70.36
700	71.38	72.40	73.42	74.44	75.46	76.48	77.50	78.52	79.54	80.56
800	81.58	82.60	83.62	84.64	85.66	86.68	87.70	88.71	89.73	90.75
900	91.77	92.79	93.81	94.83	95.85	96.87	97.89	98.91	99.93	100.95
1000	101.97	102.99	104.01	105.03	106.05	107.07	108.09	109.11	110.13	111.15



## Sertlik Dönüşüm Tablosu

### Hardness Conversion Table

Vickers Sertlik Hardness	Brinell Sertlik Hardness	Rockwell Sertlik Hardness		Çekme dayanımı Tensile Strength
HV 30	HB 30	HRB	HRC	sB N/mm2
80	80.7	36.4	-	270
85	85	42.4	-	290
90	90	47.4	-	310
95	95	52.00	-	320
100	100	56.4	-	340
105	105	60.0	-	360
110	110	63.4	-	380
115	115	66.4	-	390
120	120	69.4	-	410
125	125	72.0	-	420
130	130	74.4	-	440
135	135	76.4	-	460
140	140	78.4	-	470
145	145	80.4	-	490
150	150	82.2	-	500
155	155	83.8	-	520
160	160	85.4	-	540
165	165	86.8	-	550
170	170	88.2	-	570
175	175	89.6	-	590
180	180	90.8	-	600
185	185	91.8	-	620
195	190	91.5	-	640
200	195	94.0	-	660
200	200	95.0	-	670
205	205	95.8	-	680
210	210	96.6	-	710
215	215	97.4	-	720
220	220	98.2	-	730
225	225	99.0	-	750
230	230	-	19.2	760
235	235	-	20.2	780
240	240	-	21.2	800
245	245	-	22.1	820
250	250	-	23.0	830
255	255	-	23.8	850
260	260	-	24.6	870
265	265	-	25.4	880
280	280	-	27.1	900
275	275	-	26.9	920
280	280	-	27.6	940
285	285	-	28.3	950
290	290	-	29.0	970
295	295	-	29.6	990
300	300	-	30.3	1010
310	310	-	31.5	1040
320	320	-	32.7	1080
330	330	-	33.8	1110

Vickers Sertlik Hardness	Brinell Sertlik Hardness	Rockwell Sertlik Hardness		Çekme dayanımı Tensile Strength
HV 30	HB 30	HRB	HRC	sB N/mm2
340	340	-	34.9	1140
350	350	-	36.0	1170
360	359	-	37.0	1200
370	368	-	38.0	1260
380	376	-	38.9	1260
390	385	-	39.8	1290
400	392	-	40.7	1320
410	400	-	41.5	1350
420	408	-	42.4	1380
440	423	-	44.0	1430
450	430	-	44.8	1460
460	-	-	45.6	-
470	-	-	46.3	-
480	-	-	47.0	-
490	-	-	47.7	-
500	-	-	48.3	-
510	-	-	49.1	-
520	-	-	49.7	-
530	-	-	50.4	-
540	-	-	51.0	-
550	-	-	51.6	-
560	-	-	52.2	-
570	-	-	52.8	-
580	-	-	53.3	-
590	-	-	53.9	-
600	-	-	54.4	-
610	-	-	55.0	-
620	-	-	55.5	-
630	-	-	56.0	-
640	-	-	56.5	-
650	-	-	57.0	-
660	-	-	57.5	-
670	-	-	58.0	-
680	-	-	58.5	-
690	-	-	59.0	-
700	-	-	59.5	-
720	-	-	60.4	-
740	-	-	61.2	-
760	-	-	62.0	-
780	-	-	62.8	-
800	-	-	63.6	-
820	-	-	64.3	-
840	-	-	65.0	-
860	-	-	65.7	-
880	-	-	66.3	-
900	-	-	66.9	-
920	-	-	67.5	-
940	-	-	68.0	-

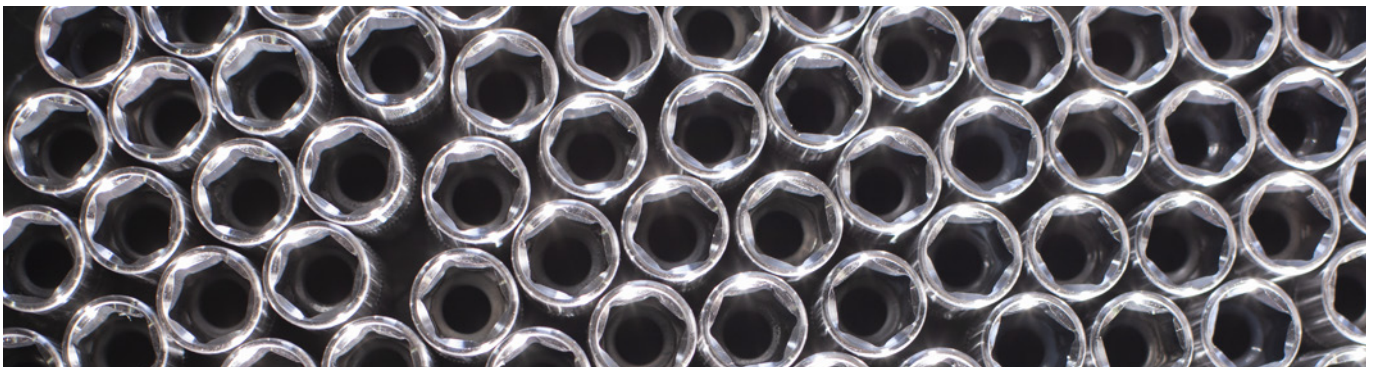

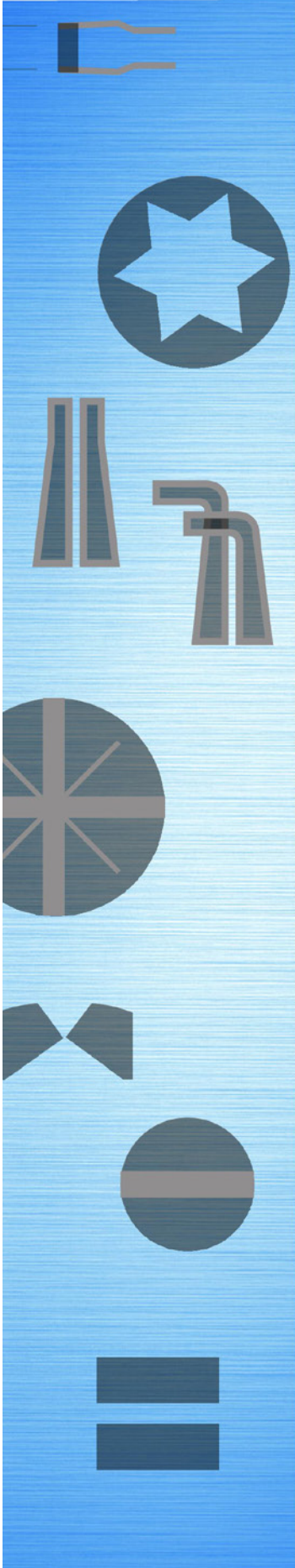

**Semboller / Symbols**

**Anahtar Ağız**  
Size



**Ağız Açıklığı**  
Opening Limit of Jaws



**Altı Köşe Lokma Bijon**  
**Anahtar Ağız**  
Six Point Sockets



**Sekiz Köşe Anahtar Ağız**  
Eight Point Wrench



**On iki Köşe Anahtar Ağız**  
Twelve Point Wrench



**Kare Adaptör**  
Square Adapter



**Kovan Anahtar**  
Tubular Socket Wrench



**Bir Ağız Bijon Anahtar**  
Single Ended Rim Wrench



**TORX® Lokma Anahtar**  
TORX® Socket



**Düz Uç**  
Flat Tip



**Yıldız Uç**  
PHILLIPS® Tip



**POZIDRIV® Yıldız Uç**  
POZIDRIV® Tip



**TORX® Uç**  
TORX® Tip



**Delikli TORX® Uç**  
TORX® with hole



**Bits Tutucular**  
Bit Holders



**Allen Anahtar**  
Hexagonal Allen Keys



**Segman**  
Circlip



**Gövde Ağırlık**  
Weight of Body



**Tapa Anahtar**  
Wrench for Carter Case



**İşkençe**  
Screw Clamp



**Çektirme**  
Puller



in.	dec.in.	0"	1"	2"	3"	4"	5"	6"	7"	8"	9"	10"	11"
		millimeters (mm)											
0	0	0	25.400 0	50.800 0	76.200 0	101.600 0	127.000 0	152.400 0	177.800 0	203.200 0	228.600 0	254.000 0	279.400 0
1/64	0.015 625	0.396 9	25.796 9	51.196 9	76.596 9	101.996 9	127.396 9	152.796 9	178.196 9	203.596 9	228.996 9	254.396 9	279.796 9
1/32	0.031 25	0.793 8	26.193 8	51.593 8	76.993 8	102.393 8	127.793 8	153.193 8	178.593 8	203.993 8	229.393 8	254.793 8	280.193 8
3/64	0.046 875	1.190 6	26.590 6	51.990 6	77.390 6	102.790 6	128.190 6	153.590 6	178.990 6	204.390 6	229.790 6	255.190 6	280.590 6
1/16	0.062 5	1.587 5	26.987 5	52.387 5	77.787 5	103.187 5	128.587 5	153.987 5	179.387 5	204.787 5	230.187 5	255.587 5	280.987 5
5/64	0.078 125	1.984 4	27.384 4	52.784 4	78.184 4	103.584 4	128.984 4	154.384 4	179.784 4	205.184 4	230.584 4	255.984 4	281.384 4
3/32	0.093 75	2.381 2	27.781 2	53.181 2	78.581 2	103.981 2	129.381 2	154.781 2	180.181 2	205.581 2	230.981 2	256.381 2	281.781 2
7/64	0.109 375	2.778 1	28.178 1	53.578 1	78.978 1	104.378 1	129.778 1	155.178 1	180.578 1	205.978 1	231.378 1	256.778 1	282.178 1
1/8	0.125	3.175 0	28.575 0	53.975 0	79.375 0	104.775 0	130.175 0	155.575 0	180.975 0	206.375 0	231.775 0	257.175 0	282.575 0
9/64	0.140 625	3.571 9	28.971 9	54.371 9	79.771 9	105.171 9	130.571 9	155.971 9	181.371 9	206.771 9	232.171 9	257.571 9	282.971 9
5/32	0.156 25	3.968 8	29.368 8	54.768 8	80.168 8	105.568 8	130.968 8	156.368 8	181.768 8	207.168 8	232.568 8	257.968 8	283.368 8
11/64	0.171 875	4.365 6	29.765 6	55.165 6	80.565 6	105.965 6	131.365 6	156.765 6	182.165 6	207.565 6	232.965 6	258.365 6	283.765 6
3/16	0.187 5	4.762 5	30.162 5	55.562 5	80.962 5	106.362 5	131.762 5	157.162 5	182.562 5	207.962 5	233.362 5	258.762 5	284.162 5
13/64	0.203 125	5.159 4	30.559 4	55.959 4	81.359 4	106.759 4	132.159 4	157.559 4	182.959 4	208.359 4	233.759 4	259.159 4	284.559 4
7/32	0.218 75	5.556 2	30.956 2	56.356 2	81.756 2	107.156 2	132.556 2	157.956 2	183.356 2	208.756 2	234.156 2	259.556 2	284.956 2
15/64	0.234 375	5.953 1	31.353 1	56.753 1	82.153 1	107.553 1	132.953 1	158.353 1	183.753 1	209.153 1	234.553 1	259.953 1	285.353 1
1/4	0.25	6.350 0	31.750 0	57.150 0	82.550 0	107.950 0	133.350 0	158.750 0	184.150 0	209.550 0	234.950 0	260.350 0	285.750 0
17/64	0.265 625	6.746 9	32.146 9	57.546 9	82.946 9	108.346 9	133.746 9	159.146 9	184.546 9	209.946 9	235.346 9	260.746 9	286.146 9
9/32	0.281 25	7.143 8	32.543 8	57.943 8	83.343 8	108.743 8	134.143 8	159.543 8	184.943 8	210.343 8	235.743 8	261.143 8	286.543 8
19/64	0.296 875	7.540 6	32.940 6	58.340 6	83.740 6	109.140 6	134.540 6	159.940 6	185.340 6	210.740 6	236.140 6	261.540 6	286.940 6
5/16	0.312 5	7.937 5	33.337 5	58.737 5	84.137 5	109.537 5	134.937 5	160.337 5	185.737 5	211.137 5	236.537 5	261.937 5	287.337 5
21/64	0.328 125	8.334 4	33.734 4	59.134 4	84.534 4	109.934 4	135.334 4	160.734 4	186.134 4	211.534 4	236.934 4	262.334 4	287.734 4
11/32	0.343 75	8.731 2	34.131 2	59.531 2	84.931 2	110.331 2	135.731 2	161.131 2	186.531 2	211.931 2	237.331 2	262.731 2	288.131 2
23/64	0.359 375	9.128 1	34.528 1	59.928 1	85.328 1	110.728 1	136.128 1	161.528 1	186.928 1	212.328 1	237.728 1	263.128 1	288.528 1
3/8	0.375	9.525 0	34.925 0	60.325 0	85.725 0	111.125 0	136.525 0	161.925 0	187.325 0	212.725 0	238.125 0	263.525 0	288.925 0
25/64	0.390 625	9.921 9	35.321 9	60.721 9	86.121 9	111.521 9	136.921 9	162.321 9	187.721 9	213.121 9	238.521 9	263.921 9	289.321 9
13/32	0.406 25	10.318 8	35.718 8	61.118 8	86.518 8	111.918 8	137.318 8	162.718 8	188.118 8	213.518 8	238.918 8	264.318 8	289.718 8
27/64	0.421 875	10.715 6	36.115 6	61.515 6	86.915 6	112.315 6	137.715 6	163.115 6	188.515 6	213.915 6	239.315 6	264.715 6	290.115 6
7/16	0.437 5	11.112 5	36.512 5	61.912 5	87.312 5	112.712 5	138.112 5	163.512 5	188.912 5	214.312 5	239.712 5	265.112 5	290.512 5
29/64	0.453 125	11.509 4	36.909 4	62.309 4	87.709 4	113.109 4	138.509 4	163.909 4	189.309 4	214.709 4	240.109 4	265.509 4	290.909 4
15/32	0.468 75	11.906 2	37.306 2	62.706 2	88.106 2	113.506 2	138.906 2	164.306 2	189.706 2	215.106 2	240.506 2	265.906 2	291.306 2
31/64	0.484 375	12.303 1	37.703 1	63.103 1	88.503 1	113.903 1	139.303 1	164.703 1	190.103 1	215.503 1	240.903 1	266.303 1	291.703 1
1/2	0.5	12.700 0	38.100 0	63.500 0	88.900 0	114.300 0	139.700 0	165.100 0	190.500 0	215.900 0	241.300 0	266.700 0	292.100 0
33/64	0.515 625	13.096 9	38.496 9	63.896 9	89.296 9	114.696 9	140.096 9	165.496 9	190.896 9	216.296 9	241.696 9	267.096 9	292.496 9
17/32	0.531 25	13.493 8	38.893 8	64.293 8	89.693 8	115.093 8	140.493 8	165.893 8	191.293 8	216.693 8	242.093 8	267.493 8	292.893 8
35/64	0.546 875	13.890 6	39.290 6	64.690 6	90.090 6	115.490 6	140.890 6	166.290 6	191.690 6	217.090 6	242.490 6	267.890 6	293.290 6
9/16	0.562 5	14.287 5	39.687 5	65.087 5	90.487 5	115.887 5	141.287 5	166.687 5	192.087 5	217.487 5	242.887 5	268.287 5	293.687 5
37/64	0.578 125	14.684 4	40.084 4	65.484 4	90.884 4	116.284 4	141.684 4	167.084 4	192.484 4	217.884 4	243.284 4	268.684 4	294.084 4
19/32	0.593 75	15.081 2	40.481 2	65.881 2	91.281 2	116.681 2	142.081 2	167.481 2	192.881 2	218.281 2	243.681 2	269.081 2	294.481 2
39/64	0.609 375	15.478 1	40.878 1	66.278 1	91.678 1	117.078 1	142.478 1	167.878 1	193.278 1	218.678 1	244.078 1	269.478 1	294.878 1
5/8	0.625	15.875 0	41.275 0	66.675 0	92.075 0	117.475 0	142.875 0	168.275 0	193.675 0	219.075 0	244.475 0	269.875 0	295.275 0
41/64	0.640 625	16.271 9	41.671 9	67.071 9	92.471 9	117.871 9	143.271 9	168.671 9	194.071 9	219.471 9	244.871 9	270.271 9	295.671 9
21/32	0.656 25	16.668 8	42.068 8	67.468 8	92.868 8	118.268 8	143.668 8	169.068 8	194.468 8	219.868 8	245.268 8	270.668 8	296.068 8
43/64	0.671 875	17.065 6	42.465 6	67.865 6	93.265 6	118.665 6	144.065 6	169.465 6	194.865 6	220.265 6	245.665 6	271.065 6	296.465 6
11/16	0.687 5	17.462 5	42.862 5	68.262 5	93.662 5	119.062 5	144.462 5	169.862 5	195.262 5	220.662 5	246.062 5	271.462 5	296.862 5
45/64	0.703 125	17.859 4	43.259 4	68.659 4	94.059 4	119.459 4	144.859 4	170.259 4	195.659 4	221.059 4	246.459 4	271.859 4	297.259 4
23/32	0.718 75	18.256 2	43.656 2	69.056 2	94.456 2	119.856 2	145.256 2	170.656 2	196.056 2	221.456 2	246.856 2	272.256 2	297.656 2
47/64	0.734 375	18.653 1	44.053 1	69.453 1	94.853 1	120.253 1	145.653 1	171.053 1	196.453 1	221.853 1	247.253 1	272.653 1	298.053 1
3/4	0.75	19.050 0	44.450 0	69.850 0	95.250 0	120.650 0	146.050 0	171.450 0	196.850 0	222.250 0	247.650 0	273.050 0	298.450 0
49/64	0.765 625	19.446 9	44.846 9	70.246 9	95.646 9	121.046 9	146.446 9	171.846 9	197.246 9	222.646 9	248.046 9	273.446 9	298.846 9
25/32	0.781 25	19.843 8	45.243 8	70.643 8	96.043 8	121.443 8	146.843 8	172.243 8	197.643 8	223.043 8	248.443 8	273.843 8	299.243 8
51/64	0.796 875	20.240 6	45.640 6	71.040 6	96.440 6	121.840 6	147.240 6	172.640 6	198.040 6	223.440 6	248.840 6	274.240 6	299.640 6
13/16	0.812 5	20.637 5	46.037 5	71.437 5	96.837 5	122.237 5	147.637 5	173.037 5	198.437 5	223.837 5	249.237 5	274.637 5	300.037 5
53/64	0.828 125	21.034 4	46.434 4	71.834 4	97.234 4	122.634 4	148.034 4	173.434 4	198.834 4	224.234 4	249.634 4	275.034 4	300.434 4
27/32	0.843 75	21.431 2	46.831 2	72.231 2	97.631 2	123.031 2	148.431 2	173.831 2	199.231 2	224.631 2	250.031 2	275.431 2	300.831 2
55/64	0.859 375	21.828 1	47.228 1	72.628 1	98.028 1	123.428 1	148.828 1	174.228 1	199.628 1	225.028 1	250.428 1	275.828 1	301.228 1
7/8	0.875	22.225 0	47.625 0	73.025 0	98.425 0	123.825 0	149.225 0	174.625 0	200.025 0	225.425 0	250.825 0	276.225 0	301.625 0
57/64	0.890 625	22.621 9	48.021 9	73.421 9	98.821 9	124.221 9	149.621 9	175.021 9	200.421 9	225.821 9	251.221 9	276.621 9	302.021 9
29/32	0.906 25	23.018 8	48.418 8	73.818 8	99.218 8	124.618 8	150.018 8	175.418 8	200.818 8	226.218 8	251.618 8	277.018 8	302.418 8
59/64	0.921 875	23.415 6	48.815 6	74.215 6	99.615 6	125.015 6	150.415 6	175.815 6	201.215 6	226.615 6	252.015 6	277.415 6	302.815 6
15/16	0.937 5	23.812 5	49.212 5	74.612 5	100.012 5	125.412 5	150.812 5	176.212 5	201.612 5	227.012 5	252.412 5	277.812 5	303.212 5
61/64	0.953 125	24.209 4	49.609 4	75.009 4	100.409 4	125.809 4	151.209 4	176.609 4	202.009 4	227.409 4	252.809 4	278.209 4	303.609 4
31/32	0.968 75	24.606 2	50.006 2	75.406 2	100.806 2	126.206 2	151.606 2	177.006 2	202.406 2	227.806 2	253.206 2	278.606 2	304.006 2
63/64	0.984 375	25.003 1	50.403 1	75.803 1	101.20								



**KALİTE GÜVENCE TESTLERİ / QUALITY ASSURANCE TEST**

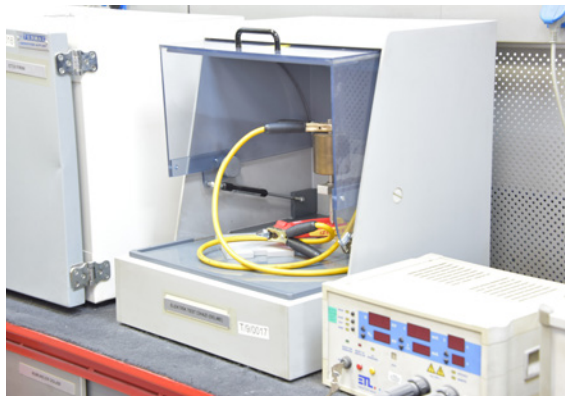





## YASAL UYARILAR / LEGAL NOTIE

Bu katalog, önceki baskıların yerine geçer. Katalog içerisinde yer alan ürünlerin teknik özellikleri, görünümü, ölçüleri katalogun yayınlandığı tarihteki mevcut şartları temsil etmektedir. Bu sebeple sipariş verilmeden önce mutlaka firma ile iletişime geçerek sipariş tarihindeki ürünlere ilişkin güncel bilgileri öğrenmenizi öneririz. Katalogta belirtilen ürünlere ait teknik özellikler, görünüm veya ölçü gibi özelliklerin sipariş tarihindeki ürünler ile aynı olmamasından kaynaklı firmanın her ne nam altında olursa olsun hiçbir sorumluluğu bulunmamaktadır. Bu bilgiler doğrultusunda, firma işbu katalog içeriğinde yer alan bilgilerden veya görsel malzemeden kaynaklanabilecek hatalardan, maddi veya manevi zararlardan hiç bir şekil ve surette sorumlu değildir.

Firma katalog içeriğinde yer alan bilgiler veya ürünler ile ilgili önceden haber vermeksizin tek taraflı değişiklikler yapabilir. Firma dilediği zaman, ürünlerinin teknik özelliklerini, görsellerini veya ölçülerini veya ürünlerini tamamen veya kısmen değiştirme hakkına sahiptir. Kataloglarda yer alan görsellerde gözükken montaj, bağlantı detayları, kullanım alanları veya güvenlik önlemleri ürünlerin doğru kullanımı için bir örnek teşkil etmez. Ürünleri kullanan kişiler, katalog içeriğinde yer alan ürünler ile ilgili güvenlik uyarılarına ve ayrıca ürünlere ilişkin ek güvenlik/kullanım talimatlarına uymakla yükümlüdür, aksi takdirde ortaya çıkacak zararlardan firma hiçbir suretle sorumlu tutulamaz.

İşbu Katalog, tüm sayfaları, içeriğindeki bilgiler ve ürünler firmanın fikri ve sınai hakları kapsamında korunmaktadır. Ürün katalogu, içeriğindeki tüm bilgiler ile görseller ve ürünlere ilişkin telif hakkı İzeltaş İzmir El Aletleri Sanayi ve Ticaret A.Ş.'ye aittir. Firmanın yazılı izni olmadan işbu telif hakkına konu ürünlerin, bilgilerin, görsellerin veya katalogun izinsiz kullanılması, yayımlanması, üretilmesi, dağıtılması ve çoğaltılması yasaktır, aksi durum firmanın fikri ve sınai hakkın ihlali sonucunu doğuracaktır.

*This catalog replaces previous editions.*

*The technical features, appearance and dimensions of the products in the catalog represent the current conditions at the date of publication of the catalog. For this reason, we recommend that you contact the company before ordering and learn the current information about the products on the order date. The company does not have any responsibility under any name due to the fact that the technical features, appearance or size of the products specified in the catalog are not the same as the products on the order date. In line with this information, the company is not responsible in any way or form for any errors, material or moral damages that may arise from the information or visual material contained in this catalogue.*

*The company may make unilateral changes regarding the information or products in the catalog without prior notice. The company reserves the right to change the technical specifications, images or dimensions of its products or products, in whole or in part, at any time. The assembly, connection details, usage areas or safety measures seen in the images in the catalogs do not constitute an example for the correct use of the products. Persons using the products are obliged to comply with the safety warnings regarding the products in the catalog content, as well as the additional safety / usage instructions regarding the products, otherwise the company cannot be held responsible for any damages that may arise.*

*This Catalog, all its pages, the information and products in it are protected within the scope of the intellectual and industrial rights of the company. The copyright of the product catalog, all the information in its content, images and products belongs to İzeltaş İzmir El Aletleri Sanayi ve Ticaret A.Ş. Unauthorized use, publication, production, distribution and reproduction of the products, information, images or catalog subject to this copyright without the written permission of the company is prohibited, otherwise it will result in violation of the intellectual and industrial rights of the company.*



### İŞIKKENT FABRİKASI



58.000 m<sup>2</sup> Açık 24.320 m<sup>2</sup> Kapalı Alan

### TURGUTLU FABRİKASI



40.000 m<sup>2</sup> Açık 25.000 m<sup>2</sup> Kapalı Alan

### SÜTÇÜLER FABRİKASI



41.225 m<sup>2</sup> Açık 14.050 m<sup>2</sup> Kapalı Alan

### ALİAĞA FABRİKASI



50.000 m<sup>2</sup> Kapalı Alan





OCAK 2025

**İzeltaş İzmir El Aletleri Sanayi ve Ticaret A.Ş.**  
Kemalpaşa Cad. No: 303 Işıkkent / İzmir / TÜRKİYE

**Sipariş Telefon / Phone for Orders**

DT : +90 232 472 13 92

T : +90 232 472 13 75

F : +90 232 472 13 78

**Adana Bölge Müdürlüğü / Adana Office**

+90 533 495 53 09

**Ankara Bölge Müdürlüğü / Ankara Office**

+90 533 603 47 29

**İstanbul Bölge Müdürlüğü / Istanbul Office**

+90 535 461 54 87 - +90 538 095 49 10

izeltas\_

/izeltaselaletleri

İZELTAŞ

izeltas A.S.

[www.izeltas.com.tr](http://www.izeltas.com.tr)