

2022 ÜRÜN KATALOĞU

2022

YASAL UYARI: Firmamız, GFB marka ürünlerin Türkiye' deki tek distribütörü ve yasal temsilcisidir. GFB tescilli bir marka olup yasal koruma altındadır. Bu markanın her türlü taklidini yapmak, ithal etmek veya satmak kanunen yasaktır. Bu kurallara uymayan taklitçi firmalar hakkında yasal işlemleri başlatıp, kararlılıkla takipçisi olacağımızı bildirmek isteriz.



GÜVEN İTHALAT - İHRACAT ve TİC. LTD. ŞTİ.
KÜSGET Örnek Sanayi Sitesi 8 Nolu Cad. No:18 Şehitkamil / GAZİANTEP
Tel: +90 342 235 09 80 (pbx) Fax: +90 342 235 09 88
e-mail:info@gfb.com.tr



www.gfb.com.tr

Hakkımızda

Firmamız ilk olarak 1992 yılında Gaziantep Tarihi Büyük Pasajında kurulmuş olup, bugün ise 3.000 metrekare kapalı alana sahip kendi yerinde Teknik Hırdavat ürünleri ithalatı ve toptan satışı gerçekleştirmektedir. Firmamız 25 yılı aşkın süredir ithalatını yapmış olduğu ölçü aletleri, kesici takımlar ve tutucu takımlar konusunda uzmanlaşmış kadrosu, tecrübesi ve teknik bilgi birikimiyle siz değerli müşterilerimize en iyi şekilde hizmet vermeye çalışmaktadır.

Asıl amacımız; sürekli yeniliklere açık olarak ürün çeşitlerimizi arttırmak ve Türkiye'de yüksek kalitesi ve ekonomik fiyatları ile kendini kanıtlamış olan tescilli markamız GFB®'i daha kurumsal bir markaya dönüştürerek sürekliliğini sağlamaktır.

Yenilenen 2022 yılı yeni kataloğumuz ile ihtiyaçlarınıza daha profesyonelce ve hızlı bir şekilde cevap verebilme gayreti içinde olmayı hedefliyoruz.

Bugünlere gelmemizde katkıları olan siz değerli müşterilerimize teşekkür eder, hayırlı kazançlar dileriz.

GÜVEN İthalat - İhracat





SATIŞ KOŞULLARI

- 1- Fiyatlarımız USD (\$) bazında olup, KDV dahil değildir. Serbest piyasa döviz kurları geçerlidir.
- 2- Peşin ve vadeli ödemelerde uygulanacak iskonto oranları için lütfen bilgi alınız.
İskonto oranı peşin ödemelerde %_____, vadeli ödemelerde %_____ 'dir.
- 3- Satışı yapılan ürünler depo teslimi olup, her türlü ambar ve kargo ücreti müşteriye aittir.
- 4- Hesap mutabakatlarınızı periyodik zamanlarda muhasebemiz ile muhakkak yapınız.
- 5- Yanlış giden veya arızalı olan ürünlerin iadesi tarafımıza bilgi verilmek koşuluyla 10 iş günü içinde kabul edilir. Amacı dışında kullanılmış ve ambalajı deforme olmuş ürünlerin iadesi kabul edilmeyecektir.
- 6- Dosya ve evrak gönderilerinizi şirketimizin anlaşmalı olduğu kargo firmasıyla yapmanız rica olunur. Sözleşme kodunu ve anlaşmalı kargo firmasını sorunuz.
- 7- Stoklarımızda biten ürünler en geç 30 - 45 iş günü içerisinde normal koşullarda mevcut olur.
- 8- Bu katalogta yer alan ürün fiyatları Mayıs 2022 tarihinde güncellenmiş olup, firmamız Güven İthalat İhracat haber vermeksizin bu fiyatları değiştirme hakkına sahiptir.

Bu ürün katalogunda bulunan fotoğrafların ve yazıların izin alınmadan kullanılması veya kopyalanması kanunlara göre suçtur. Bu kanunun ihlali durumunda yasal işlem başlatılacaktır.

BANKA HESAP NUMARALARIMIZ



₺ IBAN : TR23 0006 2001 0780 0006 2987 53



\$ IBAN : TR75 0006 2001 0780 0009 0951 03



₺ IBAN : TR68 0001 2001 2460 0010 1007 24



₺ IBAN : TR31 0006 4000 0016 3070 3630 01



₺ IBAN : TR20 0020 5000 0001 9238 3000 01



₺ IBAN : TR29 0004 6006 6288 8000 1437 37



₺ IBAN : TR97 0006 7010 0000 0094 4474 46



₺ IBAN : TR84 0011 1000 0000 0092 1605 39



₺ IBAN : TR92 0020 9000 0100 7901 0000 01

İÇİNDEKİLER



ÖLÇÜ ALETLERİ

08 - 19

Kumpaslar	8
Mikrometreler	10
Yükseklik Mihengirleri	13
Komparatör Saatleri	14
Komparatör Takımları	15
Manyetik Ayak	16
Mastarlar	17
Sentil	17
Diş Tarağı	17
Proplar	17
Gönyeler	18



HSS MATKAP UÇLARI

22 - 26

Siyah / Beyaz	22
Titanyum Kaplı	23
Matkap Ucu Setleri	23
Süper Matkap Ucu	24
Uzun Matkap Ucu	24
HSS - E Co Altın Seri	25
HSS Süper Uzun Matkap Ucu	25
HSS Morslu Konik	26



KIRICI - DELİCİ MATKAP UÇLARI

30 - 41

SDS Plus	30
SDS Plus 4 Elmaslı	32
SDS Max	33
SDS Kalıpcı Matkap Ucu	33
Keski ve Murçlar	34
SDS Ağaç Delme Matkap Ucu	35
Dekupaj Ağızları	36
Tilki Kuyrukları	37
Havşa Uçları	38
Yaprak Matkap Ucu ve Seti	39
Cam - Seramik Delme Matkap Uçları	39
Alüminyum Freze Uçları	40



KESİCİLER, PANÇLAR ve FIRÇALAR

44 - 55

Flap Zımparalar	44
Mermer Granit Kesiciler	45
Sunta Elmas Testere	45
Kesici ve Aşındırıcı Taşlar	46
Elmaslı Beton Delme Panç ve Adaptörleri	47
Bi - Metal Pançlar ve Adaptörleri	48
Bi-Metal Panç Merkezleme Ucu	48
TCT Metal Delme Pançları	49
Mermer Granit Pançlar	50
Kademeli Saç Delme Uçları	51
Buat Açma Seti	51
Fırçalar	52
Profesyonel Şerit Metre	54
Köpük Tabancası	54
Eko Şerit Metre	54
Silikon-Epoksi Tabanca	55



MAKET BIÇAKLARI

58 - 59

Metal Maket Bıçakları	58
Plastik Maket Bıçakları	58
Maket Bıçak Yedekleri	59



TORNA VIDA UÇLARI

62 - 68

Kare Yıldız Bits Uç	62
Kare Pozi Bits Uç	62
Kare Tork Bits Uç	62
Kare Düz Bits Uç	62
Yuvarlak Yıldız Bits Uç	63
Yuvarlak Pozi Bits Uç	63
Yuvarlak Tork Bits Uç	63
Yuvarlak Düz Bits Uç	63
Allen Bits Uç	64
1/2" Lokmalı Bits Uçlar	64
Tork Otomotiv Bits Uç	65
Allen Otomotiv Bits Uç	65
Bits Uzatma Adaptörleri	66
Şapkalı Yıldız Bits Uç	66
Bükülebilir Bits Uzatma	67
Manyetik Somun Lokmaları	67
Lokma Adaptörleri	68
40 Parçalı Bits Uç Seti	68



TORNA AYNALARI VE TUTUCULAR

72 - 82

Torna Aynaları	72
Torna Ayna Yedek Parçaları	75
Döner Punta	77
Mors Konik	77
Mors Kovan	77
Mandrenler	78
Mandren Anahtarları ve Adaptörleri	79
ER Pensler	80
OZ Pensler	81
Pens Setleri	82
Pens Başlıkları	82
Çektirme Civatası	82
Er Kapaklar	82
Er Anahtarlar	82

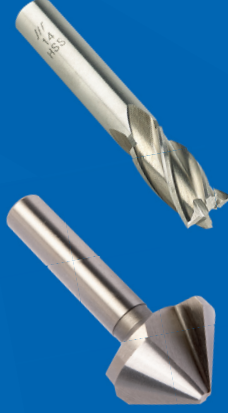

KESİCİ TAKIMLAR

86 - 90

HSS Standart Parmak Freze	86
HSS Uzun Parmak Freze	86
HSS Titan Kaplı Parmak Freze	87
HSS Kabataş Parmak Freze	87
HSS İki Ağızlı Parmak Freze	88
Karbür Elmas Freze	88
Karbür Küre Elmas Freze	88
Torna ve Keski Kalemleri	89
HSS Havşa Freze	90
HSS Punta Uçları	90
HSS Punta Çürütme Ucu	90



KARBÜR KALIPÇI FREZE

94 - 95

A - Silindir Düz	94
B - Silindir Alın Kesmeli	94
C - Silindir Oval Başlı	94
D - Küre Başlı	94
E - Oval Gövdeli	94
F - Küre Uçlu Çam	95
G - Sivri Çam	95
H - Alev	95
L - Konik Yuvarlak	95
M - Konik Sivri	95



HSS KILAVUZ ve PAFTALAR

98 - 110

HSS 3'lü El Takım Kılavuzu	98
HSS Titanyum Düz İnce Diş Makina Kılavuzu	98
HSS Titanyum Düz Makina Kılavuzu	99
HSS Titanyum Helis Makina Kılavuzu	99
HSS 3'lü UNC ve UNF El Takım Kılavuzları	100
HSS Tekli Son Kılavuz	101
HSS Helikol Kılavuz	101
HSS Titanyum UNC ve UNF Düz Makina Kılavuzu	102
HSS Titanyum UNC ve UNF Helis Makina Kılavuzu	103
HSS Kobalt Düz ve Helis Makina Kılavuzları	104
HSS Gaz Diş Kılavuzlar	105
HSS Metrik Paftalar	106
HSS UNC ve UNF Paftalar	107
HSS Gaz Diş Paftalar Kılavuz-Pafta Setleri	107
Ters Kılavuz Takımı	108
Kılavuz ve Pafta Kolları	109
Mengeneler	110
Kalıp Bağlama Setleri	110





Ölçü Aletleri

- Kumpaslar
- Mikrometreler
- Yükseklik Mihengirleri
- Komparatör Saatleri
- Komparatör Takımları
- Manyetik Ayak
- Masterlar
- Sentil
- Diş Tarağı
- Proplar
- Gönyeler

◆ Mekanik Kumpaslar (Ekonomik)



Kod	Özellikler	Fiyat
1000	150 x 0,05 mm (Ekonomik)	5,85 \$

Plastik kutudadır.

◆ Mekanik Kumpaslar



Kod	Özellikler	Fiyat
1001	100 x 0,02 mm	8,55 \$
1002	100 x 0,05 mm	8,55 \$
1003	150 x 0,02 mm	8,55 \$
1004	150 x 0,05 mm	8,55 \$
1005	200 x 0,02 mm	14,50 \$
1006	200 x 0,05 mm	14,50 \$
1007	300 x 0,05 mm	25,00 \$

Plastik kutudadır.

◆ Mekanik Kumpas Tek Çene



Kod	Özellikler	Çene Boyu	Fiyat
1008	500 x 0,05 mm	100 mm	47,00 \$
1009	600 x 0,05 mm	100 mm	50,00 \$
1010	1000 x 0,05 mm	125 mm	150,00 \$
1011	1500 x 0,05 mm	150 mm	320,00 \$

Tahta kutu içerisinde.

◆ Monoblok Süper Kumpas



Kod	Özellikler	Fiyat
1020	150 x 0,05 mm	19,90 \$
1021	200 x 0,05 mm	28,35 \$
1022	300 x 0,05 mm	52,00 \$

150 ve 200'lük deri kılıfta, 300'lük plastik kutudadır.

◆ Derinlik Kumpası

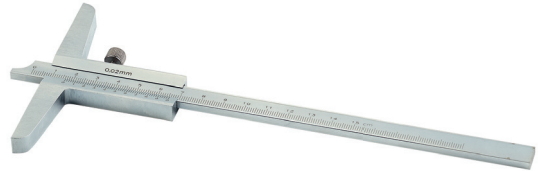

Kod	Özellikler	Fiyat
1030	150 x 0,02 mm	14,00 \$
1031	200 x 0,02 mm	16,50 \$
1032	300 x 0,02 mm	19,50 \$

Tahta kutu içerisinde.

◆ Uzun Çift Çeneli Kumpas



Kod	Özellikler	Çene Boyu	Fiyat
1040	300 x 0,05 mm	90 mm	58,50 \$
1041	500 x 0,05 mm	150 mm	92,00 \$
1042	600 x 0,05 mm	150 mm	98,00 \$
1043	1000 x 0,05 mm	150 mm	238,00 \$

Tahta kutu içerisindedir.

◆ Dijital Kumpas Büyük Ekran



Kod	Özellikler	Fiyat
1050	100 x 0,01 mm	19,00 \$
1051	150 x 0,01 mm	19,00 \$
1052	200 x 0,01 mm	30,00 \$
1053	300 x 0,01 mm	48,00 \$
1054	500 x 0,01 mm	135,00 \$

Plastik kutudadır.

◆ Dijital Kumpas Metal Ekran

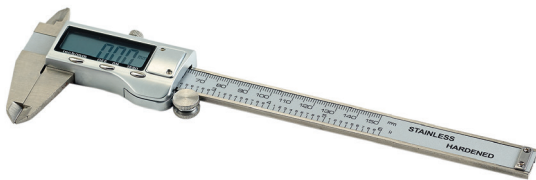

Kod	Özellikler	Fiyat
1060	150 x 0,01 mm	22,50 \$
1061	200 x 0,01 mm	33,50 \$
1062	300 x 0,01 mm	50,50 \$

Plastik kutudadır.

◆ Dijital Kumpas Mitutoyo Model



Kod	Özellikler	Fiyat
1070	150 x 0,01 mm	34,00 \$
1071	200 x 0,01 mm	49,00 \$
1072	300 x 0,01 mm	71,00 \$

Plastik kutudadır.

◆ Dijital Derinlik Kumpası



Kod	Özellikler	Fiyat
1080	150 x 0,01 mm	25,00 \$
1081	200 x 0,01 mm	37,00 \$

Plastik kutudadır.

◆ Saatli Kumpas



Kod	Özellikler	Fiyat
1100	150 x 0,02 mm	21,00 \$
1101	200 x 0,02 mm	32,00 \$

Plastik kutudadır.

◆ Dış Çap Mikrometresi



Kod	Özellikler	Fiyat
1150	0 - 25 x 0,01 mm	10,80 \$
1151	25 - 50 x 0,01 mm	13,45 \$
1152	50 - 75 x 0,01 mm	15,85 \$
1153	75 - 100 x 0,01 mm	18,50 \$
1154	100 - 125 x 0,01 mm	21,30 \$
1155	125 - 150 x 0,01 mm	23,70 \$
1156	150 - 175 x 0,01 mm	27,20 \$
1157	175 - 200 x 0,01 mm	30,30 \$
1158	200 - 225 x 0,01 mm	33,90 \$
1159	225 - 250 x 0,01 mm	37,50 \$
1160	250 - 275 x 0,01 mm	41,20 \$
1161	275 - 300 x 0,01 mm	45,50 \$
1162	300 - 400 x 0,01 mm	133,00 \$
1163	400 - 500 x 0,01 mm	190,00 \$

75 - 100'e kadar plastik kutuda, diğerleri tahta kutu içerisindedir.

◆ Mikrometre Seti (4 Parçalı)

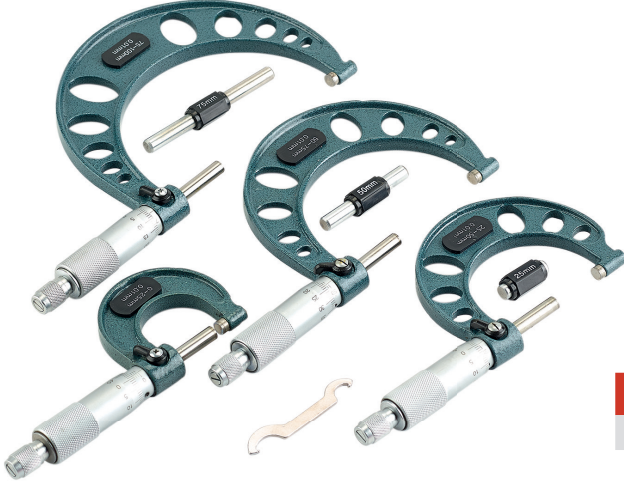

Kod	Özellikler	Fiyat
1170	0 - 25'den 75 - 100'e kadar	65,50 \$

Tahta kutu içerisindedir.

◆ Mikrometre Seti (6 Parçalı)



Kod	Özellikler	Fiyat
1175	0 - 25'den 125 - 150'ye kadar	112,00 \$

Tahta kutu içerisindedir.

◆ Dişli Mikrometresi (Şapkalı)

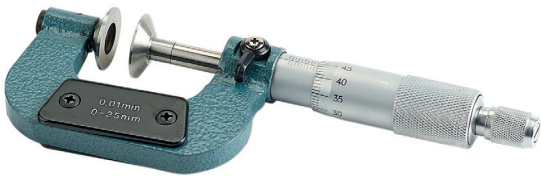

Kod	Özellikler	Fiyat
1180	0 - 25 x 0,01 mm	45,00 \$

Tahta kutu içerisindedir.

◆ Numaratörlü Mikrometre



Kod	Özellikler	Fiyat
1185	0 - 25 x 0,01 mm	34,40 \$
1186	25 - 50 x 0,01 mm	37,40 \$

Tahta kutu içerisindedir.

◆ Dijital Dış Çap Mikrometresi



Kod	Özellikler	Fiyat
1190	0 - 25 x 0,001 mm	70,50 \$
1191	25 - 50 x 0,001 mm	82,50 \$
1192	50 - 75 x 0,001 mm	97,00 \$
1193	75 - 100 x 0,001 mm	110,00 \$

Plastik ve tahta kutudadır.

◆ İç Çap Mikrometresi



Kod	Özellikler	Fiyat
1200	5 - 30 x 0,01 mm	42,00 \$
1201	25 - 50 x 0,01 mm	47,20 \$
1202	50 - 75 x 0,01 mm	53,20 \$
1203	75 - 100 x 0,01 mm	59,50 \$

Plastik ve tahta kutudadır.

◆ Derinlik Mikrometresi



Kod	Özellikler	Fiyat
1220	0 - 100 x 0,01 mm	53,10 \$
1221	0 - 150 x 0,01 mm	67,00 \$

Tahta kutu içerisinde.

◆ Delik İçi - Uzatma Mikrometre



Kod	Özellikler	Fiyat
1230	50 - 175 x 0,01 mm	86,70 \$
1231	50 - 250 x 0,01 mm	110,00 \$
1232	50 - 600 x 0,01 mm	147,00 \$

Plastik ve tahta kutudadır.

◆ Merceklı Ykseklik Mihengiri

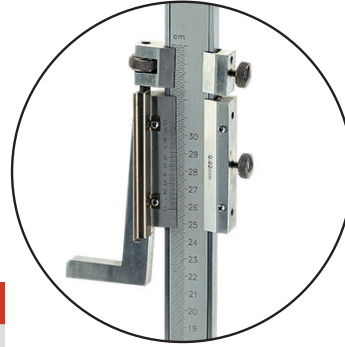

Kod	zellikler	Fiyat
1240	0 - 300 x 0,02 mm	77,00 \$
1241	0 - 500 x 0,02 mm	124,00 \$
1242	0 - 600 x 0,02 mm	135,00 \$

Plastik ve tahta kutudadır.

◆ Saatli Ykseklik Mihengiri (ift Kolonlu)



Kod	zellikler	Fiyat
1250	0 - 300 x 0,01 mm	206,00 \$
1251	0 - 500 x 0,01 mm	260,00 \$
1252	0 - 600 x 0,01 mm	350,00 \$

Kpkl karton kutudadır.

◆ Dijital Ykseklik Mihengiri (ift Kolonlu)



Kod	zellikler	Fiyat
1260	0 - 300 x 0,01 mm	362,00 \$
1261	0 - 500 x 0,01 mm	492,00 \$
1262	0 - 600 x 0,01 mm	575,00 \$

Kpkl karton kutudadır.

◆ Komparatör Saati

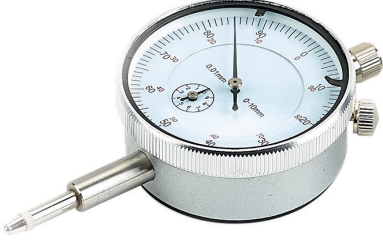

Kod	Özellikler	Fiyat
1300	0,10 x 0,01 mm (Kulaklı)	11,45 \$
1301	0,10 x 0,01 mm (Kulaksız)	11,45 \$

Köpüklü dayanıklı karton kutudadır.

◆ Komparatör Saati (Uzun Çubuklu)



Kod	Özellikler	Fiyat
1305	0 - 20 x 0,01 x 20 mm	23,80 \$
1306	0 - 30 x 0,01 x 30 mm	25,70 \$
1307	0 - 50 x 0,01 x 50 mm	64,50 \$

Köpüklü dayanıklı karton kutudadır.

◆ Salgı Komparatör Saati



Kod	Özellikler	Fiyat
1310	0,08 x 0,01 mm	30,00 \$
1311	0,08 x 0,01 mm 30 mm (Uzun)	36,50 \$

Plastik kutudadır.

◆ Dijital Komparatör Saati



Kod	Özellikler	Fiyat
1320	0 - 12,7 x 0,01 mm	29,00 \$
1321	0 - 12,7 x 0,001 mm (Mikronlu)	74,00 \$

Köpüklü dayanıklı karton kutudadır.

◆ Cep Tipi Kalınlık Komparatörü



Kod	Özellikler	Fiyat
1325	0 - 10 x 0,1 x 15 mm	10,50 \$
1326	0 - 20 x 0,1 x 20 mm	12,85 \$

Plastik kutudadır.

◆ Boru Kalınlık Komparatörü



Kod	Özellikler	Fiyat
1330	0 - 10 x 0,01 x 30 mm	33,00 \$

Plastik kutudadır.

◆ Rulmanlı Kalınlık Komparatörü



Kod	Özellikler	Fiyat
1335	0 - 10 X 0,01 x 100 mm	115,60 \$

Tahta kutu içerisinde.

◆ İç Çap Komparatörü



Kod	Özellikler	Fiyat
1340	15 - 35 x 0,01 mm	100,00 \$
1341	35 - 55 x 0,01 mm	100,00 \$
1342	55 - 75 x 0,01 mm	100,00 \$

Tahta kutu içerisinde.

◆ Silindir Komparatör Takımı



Kod	Özellikler	Fiyat
1350	10 - 18 x 0,01 mm	94,00 \$
1351	18 - 35 x 0,01 mm	60,40 \$
1352	35 - 50 x 0,01 mm	60,40 \$
1353	50 - 160 x 0,01 mm	67,80 \$
1354	160 - 250 x 0,01 mm	70,00 \$
1355	250 - 450 x 0,01 mm	100,00 \$

Plastik ve tahta kutudadır.

◆ Silindir Komparatör Takımı
Mitutoyo Model



Kod	Özellikler	Fiyat
1360	10 - 18 x 0,01 mm	103,00 \$
1361	18 - 35 x 0,01 mm	82,00 \$
1362	35 - 50 x 0,01 mm	82,00 \$
1363	50 - 160 x 0,01 mm	82,00 \$
1364	160 - 250 x 0,01 mm	108,00 \$

Kırmızı plastik kutudadır.

◆ Manyetik Ayak



Kod	Özellikler	Fiyat
1380	Manyetik Komparatör Ay. 60 Kgs.	12,00 \$

Köpüklü karton kutudadır.

◆ Manyetik V Yatağı



Kod	Özellikler	Fiyat
1390	100 x 70 x 96 mm	86,00 \$

Karton kutudadır.

◆ Johnson Master Seti



Kod	Özellikler	Fiyat
1370	47 Parçalı Set Gr.2	133,00 \$
1371	87 Parçalı Set Gr.2	215,00 \$
1372	112 Parçalı Set Gr.2	310,00 \$



◆ Radius Mastarı



Kod	Özellikler	Fiyat
1400	1 x 7 x 0,5 mm	7,80 \$
1401	7,5 x 15 x 0,5 mm	7,80 \$
1402	15,5 x 25 x 0,5 mm	7,80 \$

Plastik şeffaf poşettedir.

◆ Sentil Filler Çakısı



Kod	Özellikler	Fiyat
1410	0,05 - 1 x100 mm (20 Yapraklı)	2,25 \$
1411	0,05 - 1 x200 mm (20 Yapraklı)	4,35 \$

Plastik şeffaf poşettedir.

◆ Diş Tarağı (Metrik ve Inch)



Kod	Özellikler	Fiyat
1420	52 Parçalı Kombine Set	8,50 \$

Plastik şeffaf poşettedir.

◆ Tin Kaplı Mekanik Prop



Kod	Özellikler	Fiyat
1424	Tin Kaplı Mekanik Prop	8,50 \$

Plastik kutudadır.

◆ Mekanik Prop



Kod	Özellikler	Fiyat
1425	Mekanik Prop	5,00 \$

Plastik kutudadır.

◆ Işıklı Sesli Prop



Kod	Özellikler	Fiyat
1426	20 x 160 mm	34,50 \$

Tahta kutu içerisinde.

◆ Açılı Gönye

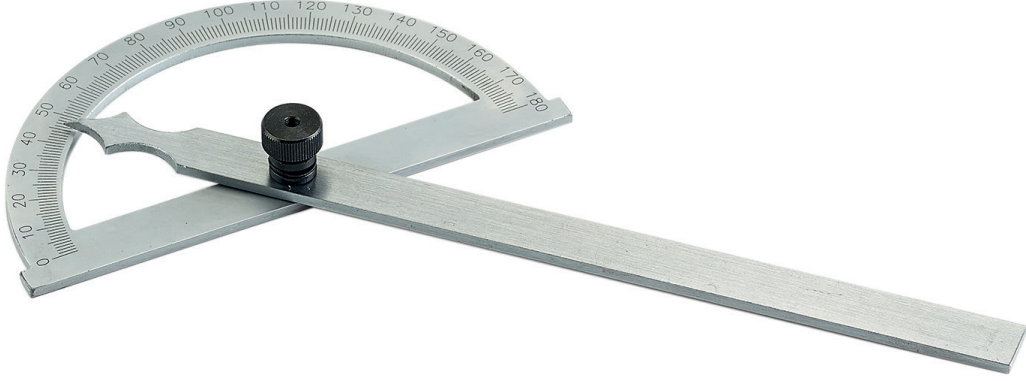

Kod	Özellikler	Fiyat
1430	80 x 120 mm	12,20 \$
1431	120 x 150 mm	14,40 \$
1432	150 x 200 mm	15,10 \$

Deri kılıftadır.

◆ Dereceli Mercekleli Gönye (3 Parçalı)

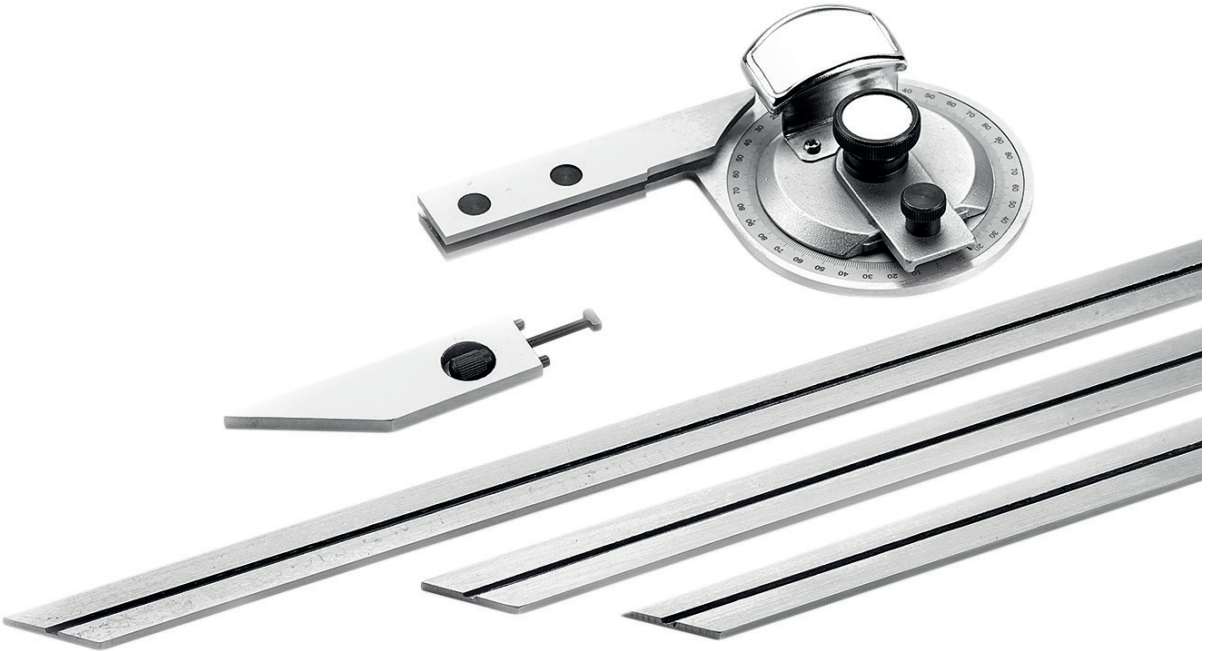

Kod	Özellikler	Fiyat
1450	0 - 10 x 0,01 mm 0-360 Derece	43,30 \$

Plastik kutudadır.

◆ Kıl Gönye - DIN 875/1



Kod	Özellikler	Fiyat
1460	70 x 100 mm	11,00 \$
1461	100 x 150 mm	16,00 \$
1462	130 x 200 mm	22,00 \$

Tahta kutu içerisindeydir.

◆ Şapkasız Gönye - DIN 875/1



Kod	Özellikler	Fiyat
1470	70 x 100 mm	7,80 \$
1471	100 x 150 mm	11,00 \$
1472	130 x 200 mm	17,00 \$

Karton kutudadır.

◆ Şapkalı Gönye - DIN 875/1



Kod	Özellikler	Fiyat
1480	70 x 100 mm	9,80 \$
1481	100 x 150 mm	14,00 \$
1482	130 x 200 mm	18,50 \$
1483	160 x 250 mm	27,50 \$
1484	200 x 300 mm	36,50 \$
1485	250 x 400 mm	63,00 \$
1486	330 x 500 mm	110,00 \$

Karton kutudadır.



HSS Matkap Uçları

- Siyah / Beyaz
- Titanyum Kaplı
- Matkap Ucu Setleri
- Süper Matkap Ucu
- Uzun Matkap Ucu
- HSS - E Co Altın Seri
- HSS Süper Uzun Matkap Ucu
- HSS Morslu Konik



◆ HSS Matkap Ucu Siyah / Beyaz - DIN 338



Kod	Özellikler	Paket	Koli	Fiyat	Kod	Özellikler	Paket	Koli	Fiyat
1500	0,8 mm	500	10000	0,12 \$	1523	9,0 mm	60	600	0,97 \$
1501	0,9 mm	500	10000	0,12 \$	1524	9,5 mm	60	600	1,08 \$
1502	1,0 mm	500	5000	0,12 \$	1525	10,0 mm	50	500	1,20 \$
1503	1,5 mm	200	5000	0,12 \$	1526	10,5 mm	50	500	1,35 \$
1504	2,0 mm	200	5000	0,14 \$	1527	11,0 mm	50	300	1,53 \$
1505	2,5 mm	250	5000	0,16 \$	1528	11,5 mm	50	300	1,67 \$
1506	3,0 mm	250	5000	0,17 \$	1529	12,0 mm	50	300	1,93 \$
1507	3,2 mm	200	4000	0,18 \$	1530	12,5 mm	50	300	2,10 \$
1508	3,5 mm	200	4000	0,18 \$	1531	13,0 mm	50	300	2,30 \$
1509	3,75 mm	100	5000	0,22 \$	1532	13,5 mm	20	200	2,88 \$
1510	4,0 mm	200	4000	0,22 \$	1533	14,0 mm	20	200	3,10 \$
1511	4,2 mm	200	4000	0,23 \$	1534	14,5 mm	20	200	3,58 \$
1512	4,5 mm	150	3000	0,25 \$	1535	15,0 mm	20	200	3,78 \$
1513	5,0 mm	100	2000	0,30 \$	1536	15,5 mm	20	200	4,17 \$
1514	5,2 mm	100	2000	0,33 \$	1537	16,0 mm	10	100	4,60 \$
1515	5,5 mm	100	2000	0,36 \$	1538	16,5 mm	10	100	5,10 \$
1516	5,8 mm	100	2000	0,37 \$	1539	17,0 mm	10	100	5,30 \$
1517	6,0 mm	100	2000	0,41 \$	1540	17,5 mm	10	100	5,75 \$
1518	6,5 mm	50	1000	0,50 \$	1541	18,0 mm	10	100	6,18 \$
1519	7,0 mm	50	1000	0,59 \$	1542	18,5 mm	10	100	6,70 \$
1520	7,5 mm	80	800	0,64 \$	1543	19,0 mm	10	100	7,00 \$
1521	8,0 mm	80	800	0,76 \$	1544	19,5 mm	10	100	7,70 \$
1522	8,5 mm	60	600	0,86 \$	1545	20,0 mm	10	100	7,95 \$

◆ Sol Matkap Ucu

Kod	Özellikler	Paket	Koli	Fiyat
1550	13,0 mm	20	200	9,50 \$



◆ HSS Matkap Ucu Titanyum Kaplı - DIN 338



Kod	Özellikler	Paket	Koli	Fiyat
1600	1,0 mm	500	10000	0,15 \$
1601	1,5 mm	200	10000	0,15 \$
1602	2,0 mm	200	10000	0,17 \$
1603	2,5 mm	250	5000	0,21 \$
1604	3,0 mm	250	5000	0,25 \$
1605	3,2 mm	200	4000	0,28 \$
1606	3,5 mm	200	4000	0,31 \$
1607	4,0 mm	200	4000	0,35 \$
1608	4,2 mm	200	4000	0,40 \$
1609	4,5 mm	150	3000	0,43 \$
1610	5,0 mm	100	2000	0,48 \$
1611	5,5 mm	100	2000	0,58 \$
1612	6,0 mm	100	2000	0,65 \$
1613	6,5 mm	50	1000	0,80 \$
1614	7,0 mm	50	1000	0,90 \$
1615	7,5 mm	80	800	0,98 \$
1616	8,0 mm	80	800	1,18 \$
1617	8,5 mm	60	600	1,30 \$
1618	9,0 mm	60	600	1,47 \$
1619	9,5 mm	60	600	1,65 \$
1620	10,0 mm	50	500	1,95 \$

Kod	Özellikler	Paket	Koli	Fiyat
1621	10,5 mm	50	500	2,10 \$
1622	11,0 mm	50	300	2,35 \$
1623	11,5 mm	50	300	2,55 \$
1624	12,0 mm	50	300	2,90 \$
1625	12,5 mm	50	300	3,10 \$
1626	13,0 mm	50	300	3,40 \$
1627	13,5 mm	20	200	4,10 \$
1628	14,0 mm	20	200	4,40 \$
1629	14,5 mm	20	200	5,00 \$
1630	15,0 mm	20	200	5,25 \$
1631	15,5 mm	20	200	6,00 \$
1632	16,0 mm	10	100	6,25 \$
1633	16,5 mm	10	100	7,00 \$
1634	17,0 mm	10	100	7,20 \$
1635	17,5 mm	10	100	7,80 \$
1636	18,0 mm	10	100	8,50 \$
1637	18,5 mm	10	100	9,00 \$
1638	19,0 mm	10	100	9,50 \$
1639	19,5 mm	10	100	10,40 \$
1640	20,0 mm	10	100	10,70 \$

◆ Matkap Ucu Seti (Siyah - Beyaz)



Kod	Özellikler	Koli	Fiyat
1560	1 mm - 10 mm / 19 PCS Set	25	14,00 \$
1561	1 mm - 13 mm / 25 PCS Set	10	29,00 \$

◆ Matkap Ucu Seti (Fully Ground - Beyaz)



Kod	Özellikler	Koli	Fiyat
1562	1 mm - 10 mm / 19 PCS Set	10	33,00 \$
1563	1 mm - 13 mm / 25 PCS Set	10	70,00 \$

◆ HSS Süper Matkap Ucu DIN 338 (Fully Ground)



Kod	Özellikler	Paket	Koli	Fiyat	Kod	Özellikler	Paket	Koli	Fiyat
1700	2,5 mm	10	3000	0,29 \$	1719	11,0 mm	5	150	4,60 \$
1701	3,0 mm	10	3000	0,50 \$	1720	11,5 mm	5	150	5,00 \$
1702	3,2 mm	10	2000	0,58 \$	1721	12,0 mm	5	150	5,58 \$
1703	3,5 mm	10	5000	0,58 \$	1722	12,5 mm	5	150	5,95 \$
1704	4,0 mm	10	3000	0,64 \$	1723	13,0 mm	5	150	6,35 \$
1705	4,2 mm	10	2000	0,70 \$	1724	13,5 mm	5	100	9,10 \$
1706	4,5 mm	10	2000	0,79 \$	1725	14,0 mm	5	100	9,25 \$
1707	5,0 mm	10	1000	0,90 \$	1726	14,5 mm	1	100	10,60 \$
1708	5,5 mm	10	1000	1,05 \$	1727	15,0 mm	1	100	11,00 \$
1709	6,0 mm	10	2200	1,22 \$	1728	15,5 mm	1	100	11,60 \$
1710	6,5 mm	10	500	1,45 \$	1729	16,0 mm	1	100	12,50 \$
1711	7,0 mm	10	500	1,72 \$	1730	16,5 mm	1	100	13,20 \$
1712	7,5 mm	10	300	1,83 \$	1731	17,0 mm	1	100	13,75 \$
1713	8,0 mm	10	500	2,20 \$	1732	17,5 mm	1	100	14,50 \$
1714	8,5 mm	10	300	2,40 \$	1733	18,0 mm	1	100	14,80 \$
1715	9,0 mm	5	300	2,82 \$	1734	18,5 mm	1	100	15,80 \$
1716	9,5 mm	5	300	3,15 \$	1735	19,0 mm	1	100	16,50 \$
1717	10,0 mm	5	600	3,60 \$	1736	19,5 mm	1	100	18,00 \$
1718	10,5 mm	5	300	4,10 \$	1737	20 mm	1	100	18,50 \$

Material No: 4341

◆ HSS Matkap Ucu Uzun DIN 340



Kod	Özellikler	Uzunluk	Paket	Koli	Fiyat	Kod	Özellikler	Uzunluk	Paket	Koli	Fiyat
1745	1 mm	56 mm	100	2000	0,33 \$	1755	5,5 mm	139 mm	100	600	1,00 \$
1746	1,5 mm	70 mm	100	2000	0,33 \$	1756	6,0 mm	139 mm	100	600	1,08 \$
1747	2 mm	85 mm	100	2000	0,36 \$	1757	6,5 mm	148 mm	50	250	1,31 \$
1748	2,5 mm	95 mm	100	2000	0,38 \$	1758	7,0 mm	156 mm	50	250	1,52 \$
1749	3 mm	100 mm	100	2000	0,53 \$	1759	7,5 mm	156 mm	50	250	1,70 \$
1750	3,5 mm	110 mm	100	1000	0,58 \$	1760	8,0 mm	165 mm	50	200	1,92 \$
1751	4,0 mm	119 mm	100	1000	0,62 \$	1761	8,5 mm	165 mm	50	200	2,20 \$
1752	4,2 mm	119 mm	100	1000	0,64 \$	1762	9,0 mm	175 mm	50	250	2,45 \$
1753	4,5 mm	126 mm	100	1000	0,73 \$	1763	9,5 mm	175 mm	50	250	2,75 \$
1754	5,0 mm	132 mm	100	1000	0,85 \$	1764	10,0 mm	184 mm	20	300	3,10 \$

◆ HSS - E Co Altın Seri Matkap Ucu (%5 Kobaltlı)



Kod	Özellikler	Paket	Kutu	Fiyat	Kod	Özellikler	Paket	Kutu	Fiyat
1798	0,70 mm	10	500	0,32 \$	1823	8,70 mm	5	50	5,20 \$
1799	0,80 mm	10	500	0,32 \$	1824	9,00 mm	5	50	5,20 \$
1800	1,00 mm	10	500	0,32 \$	1825	9,50 mm	5	50	5,80 \$
1801	1,50 mm	10	500	0,38 \$	1826	10,00 mm	5	50	6,70 \$
1802	2,00 mm	10	500	0,43 \$	1827	10,20 mm	5	50	7,30 \$
1803	2,50 mm	10	500	0,60 \$	1828	10,50 mm	5	50	7,30 \$
1804	3,00 mm	10	500	0,70 \$	1829	11,00 mm	5	50	8,50 \$
1805	3,20 mm	10	500	0,80 \$	1830	11,50 mm	5	50	9,20 \$
1806	3,30 mm	10	500	0,80 \$	1831	12,00 mm	5	50	10,50 \$
1807	3,50 mm	10	500	0,90 \$	1832	12,50 mm	5	50	11,50 \$
1808	4,00 mm	10	100	1,00 \$	1833	13,00 mm	5	50	13,00 \$
1809	4,20 mm	10	150	1,10 \$	1834	13,50 mm	1	1	18,50 \$
1810	4,30 mm	10	150	1,20 \$	1835	14,00 mm	1	1	19,50 \$
1811	4,50 mm	10	100	1,20 \$	1836	14,50 mm	1	1	22,00 \$
1812	5,00 mm	10	100	1,40 \$	1837	15,00 mm	1	1	23,00 \$
1813	5,20 mm	10	100	1,50 \$	1838	15,50 mm	1	1	24,50 \$
1814	5,50 mm	10	100	1,70 \$	1839	16,00 mm	1	1	26,50 \$
1815	6,00 mm	10	100	2,00 \$	1840	16,50 mm	1	1	28,00 \$
1816	6,50 mm	10	100	2,45 \$	1841	17,00 mm	1	1	30,00 \$
1817	6,70 mm	10	100	3,00 \$	1842	17,50 mm	1	1	32,00 \$
1818	6,80 mm	10	100	3,00 \$	1843	18,00 mm	1	1	34,00 \$
1819	7,00 mm	10	100	3,00 \$	1844	18,50 mm	1	1	37,00 \$
1820	7,50 mm	10	100	3,40 \$	1845	19,00 mm	1	1	39,50 \$
1821	8,00 mm	10	100	4,00 \$	1846	19,50 mm	1	1	42,00 \$
1822	8,50 mm	5	50	4,40 \$	1847	20,00 mm	1	1	48,00 \$

Alaşımlı çelik, paslanmaz çelik ve krom için kullanımı uygundur. Dayanıklı plastik kutudadır. 13 mm' den sonrası tek parça %100 HSS olup Cobalt'lidir.

◆ HSS Süper Uzun Matkap Ucu DIN 340 (Fully Ground)

YENİ
ÜRÜN



Kod	Özellikler	Uzunluk	Paket	Koli	Fiyat
1780	4,2 mm	119 mm	100	400	1,00 \$
1781	5,0 mm	132 mm	100	400	1,30 \$

◆ HSS Morslu Konik Matkap Ucu - DIN 345



Bu ürünler 4341 Çelikten üretilmiştir.

Kod	Özellikler	Fiyat	Kod	Özellikler	Fiyat
1900	15,0 mm	7,70 \$	1929	29,5 mm	27,50 \$
1901	15,5 mm	8,10 \$	1930	30,0 mm	27,80 \$
1902	16,0 mm	8,50 \$	1931	30,5 mm	33,70 \$
1903	16,5 mm	9,00 \$	1932	31,0 mm	34,00 \$
1904	17,0 mm	9,10 \$	1933	31,5 mm	37,70 \$
1905	17,5 mm	9,60 \$	1934	32,0 mm	38,90 \$
1906	18,0 mm	9,80 \$	1935	32,5 mm	40,10 \$
1907	18,5 mm	10,30 \$	1936	33,0 mm	41,60 \$
1908	19,0 mm	10,60 \$	1937	33,5 mm	43,90 \$
1909	19,5 mm	11,20 \$	1938	34,0 mm	44,20 \$
1910	20,0 mm	11,50 \$	1939	34,5 mm	46,30 \$
1911	20,5 mm	13,60 \$	1940	35,0 mm	47,00 \$
1912	21,0 mm	14,00 \$	1941	35,5 mm	49,30 \$
1913	21,5 mm	14,40 \$	1942	36,0 mm	50,00 \$
1914	22,0 mm	14,60 \$	1943	36,5 mm	53,00 \$
1915	22,5 mm	15,70 \$	1944	37,0 mm	53,50 \$
1916	23,0 mm	16,10 \$	1945	37,5 mm	55,50 \$
1917	23,5 mm	18,00 \$	1946	38,0 mm	56,50 \$
1918	24,0 mm	18,20 \$	1947	38,5 mm	60,00 \$
1919	24,5 mm	20,00 \$	1948	39,0 mm	60,50 \$
1920	25,0 mm	20,20 \$	1949	39,5 mm	61,00 \$
1921	25,5 mm	21,50 \$	1950	40,0 mm	61,50 \$
1922	26,0 mm	21,70 \$	1951	40,5 mm	69,00 \$
1923	26,5 mm	23,30 \$	1952	41,0 mm	69,50 \$
1924	27,0 mm	23,60 \$	1953	41,5 mm	70,00 \$
1925	27,5 mm	24,50 \$	1954	42,0 mm	71,00 \$
1926	28,0 mm	25,00 \$	1955	45,0 mm	80,00 \$
1927	28,5 mm	26,50 \$	1956	50,0 mm	99,50 \$
1928	29,0 mm	27,30 \$			

Plastik kutudadır.





A close-up, angled view of a metal drill bit, showing its flutes and the GFB logo on its side.

Kırıcı - Delici Matkap Uçları

- SDS Plus
- SDS Plus 4 Elmaslı
- SDS Max
- SDS Kalıpçı Matkap Ucu
- Keski ve Murçlar
- SDS Ağaç Delme Matkap Ucu
- Dekupaj Ağızları
- Tilki Kuyrukları
- Havşa Uçları
- Yaprak Matkap Ucu ve Seti
- Cam - Seramik Delme Matkap Uçları
- Alüminyum Freze Uçları

◆ SDS Plus Matkap Ucu (4 Kanallı)



Kod	Özellikler	Koli	Fiyat	Kod	Özellikler	Koli	Fiyat
1960	4 x 110 mm	500	0,74 \$	1985	8 x 450 mm	100	2,60 \$
1961	4 x 160 mm	400	0,80 \$	1986	9 x 110 mm	500	0,91 \$
1962	5 x 110 mm	500	0,74 \$	1987	9 x 160 mm	400	0,97 \$
1963	5 x 160 mm	400	0,80 \$	1988	9 x 210 mm	250	1,18 \$
1964	5 x 210 mm	250	0,99 \$	1989	10 x 110 mm	500	0,93 \$
1964-1	5 x 260 mm	250	1,10 \$	1990	10 x 160 mm	400	1,01 \$
1965	5,5 x 110 mm	500	0,74 \$	1991	10 x 210 mm	250	1,20 \$
1966	5,5 x 160 mm	400	0,80 \$	1992	10 x 260 mm	200	1,41 \$
1967	5,5 x 210 mm	250	1,03 \$	1993	10 x 310 mm	100	1,66 \$
1968	6 x 110 mm	500	0,74 \$	1994	10 x 350 mm	100	1,89 \$
1969	6 x 160 mm	400	0,80 \$	1995	10 x 450 mm	100	2,50 \$
1970	6 x 210 mm	250	1,01 \$	1996	11 x 110 mm	500	0,99 \$
1971	6 x 260 mm	200	1,12 \$	1997	11 x 160 mm	400	1,04 \$
1972	6 x 310 mm	100	1,47 \$	1998	11 x 210 mm	250	1,30 \$
1972-1	6 x 350 mm	250	1,80 \$	1999	12 x 110 mm	500	1,10 \$
1973	6,5 x 160 mm	250	0,84 \$	2000	12 x 160 mm	400	1,13 \$
1974	6,5 x 210 mm	200	1,04 \$	2001	12 x 210 mm	250	1,38 \$
1975	6,5 x 260 mm	200	1,17 \$	2002	12 x 260 mm	200	1,60 \$
1976	7 x 110 mm	500	0,79 \$	2003	12 x 310 mm	100	1,88 \$
1977	7 x 160 mm	400	0,91 \$	2004	12 x 350 mm	100	2,04 \$
1978	7 x 210 mm	250	1,08 \$	2005	12 x 450 mm	100	2,85 \$
1979	7 x 260 mm	200	1,30 \$	2006	13 x 160 mm	300	1,47 \$
1979-1	7 x 350 mm	250	1,80 \$	2007	13 x 210 mm	200	1,79 \$
1980	8 x 110 mm	500	0,80 \$	2008	14 x 160 mm	300	1,53 \$
1981	8 x 160 mm	400	0,93 \$	2009	14 x 210 mm	200	1,84 \$
1982	8 x 210 mm	250	1,11 \$	2010	14 x 260 mm	130	2,05 \$
1983	8 x 260 mm	200	1,30 \$	2011	14 x 310 mm	80	2,30 \$
1984	8 x 350 mm	100	1,80 \$				

Dayanıklı plastik poşettedir.

◆ SDS Plus Matkap Ucu (4 Kanallı)



Kod	Özellikler	Koli	Fiyat
2040	10 x 600 mm	50	4,00 \$
2041	12 x 600 mm	50	4,15 \$
2042	14 x 600 mm	50	4,80 \$
2043	16 x 600 mm	50	5,90 \$
2044	18 x 600 mm	40	7,00 \$
2045	20 x 600 mm	40	8,95 \$
2046	22 x 600 mm	50	10,50 \$
2047	24 x 600 mm	40	12,80 \$
2048	26 x 600 mm	30	14,15 \$
2049	28 x 600 mm	25	16,00 \$
2050	30 x 600 mm	20	20,00 \$

Kod	Özellikler	Koli	Fiyat
2012	14 x 350 mm	80	2,52 \$
2013	14 x 450 mm	80	3,13 \$
2014	15 x 160 mm	250	1,98 \$
2015	15 x 210 mm	150	2,21 \$
2016	16 x 160 mm	250	1,98 \$
2017	16 x 210 mm	150	2,22 \$
2018	16 x 260 mm	120	2,50 \$
2019	16 x 310 mm	80	2,89 \$
2020	16 x 350 mm	80	3,10 \$
2021	16 x 450 mm	80	3,86 \$
2021-1	17 x 210 mm	100	2,90 \$
2022	18 x 210 mm	100	3,00 \$
2023	18 x 260 mm	100	3,30 \$
2024	18 x 310 mm	80	3,69 \$
2025	18 x 350 mm	80	4,05 \$
2026	18 x 450 mm	80	4,90 \$
2027	20 x 210 mm	100	3,74 \$
2028	20 x 260 mm	100	4,50 \$
2029	20 x 310 mm	50	4,65 \$
2030	20 x 350 mm	50	5,10 \$
2031	20 x 450 mm	50	6,30 \$
2032	22 x 350 mm	50	6,05 \$
2033	22 x 450 mm	50	7,10 \$
2034	24 x 350 mm	40	7,35 \$
2035	24 x 450 mm	40	9,00 \$
2036	26 x 450 mm	40	10,50 \$
2037	28 x 450 mm	25	12,40 \$

Kod	Özellikler	Koli	Fiyat
2051	10 x 800 mm	50	5,75 \$
2052	12 x 800 mm	50	5,75 \$
2053	14 x 800 mm	50	6,50 \$
2054	16 x 800 mm	50	8,15 \$
2055	18 x 800 mm	50	9,60 \$
2056	20 x 800 mm	25	11,85 \$
2057	22 x 800 mm	25	13,30 \$
2058	24 x 800 mm	25	16,60 \$
2059	26 x 800 mm	25	18,40 \$
2060	28 x 800 mm	25	20,00 \$
2061	30 x 800 mm	10	25,00 \$

Kod	Özellikler	Koli	Fiyat
2062	10 x 1000 mm	25	7,50 \$
2063	12 x 1000 mm	25	7,70 \$
2064	14x 1000 mm	25	8,30 \$
2065	16 x 1000 mm	20	10,40 \$
2066	18 x 1000 mm	25	12,50 \$
2067	20 x 1000 mm	15	15,00 \$
2068	22 x 1000 mm	10	17,00 \$
2069	24 x 1000 mm	10	21,90 \$
2070	26 x 1000 mm	10	24,00 \$
2071	28 x 1000 mm	10	26,00 \$
2072	30 x 1000 mm	10	33,80 \$

Dayanıklı plastik poşettedir.

◆ 4 Elmaslı SDS Plus Matkap Ucu



Kod	Özellikler	Koli	Fiyat	Kod	Özellikler	Koli	Fiyat
2075	5 x 160 mm	200	1,03 \$	2087	10 x 210 mm	200	1,55 \$
2076	5 x 210 mm	200	1,15 \$	2088	11 x 160 mm	200	1,65 \$
2077	6 x 160 mm	200	1,03 \$	2089	11 x 210 mm	200	1,82 \$
2078	6 x 210 mm	200	1,15 \$	2090	12 x 160 mm	200	1,65 \$
2079	6,5 x 210 mm	200	1,15 \$	2091	12 x 210 mm	200	1,83 \$
2080	7 x 160 mm	200	1,20 \$	2092	14 x 160 mm	200	2,12 \$
2081	7 x 210 mm	200	1,38 \$	2093	14 x 210 mm	200	2,30 \$
2082	8 x 160 mm	200	1,23 \$	2094	16 x 160 mm	100	2,65 \$
2083	8 x 210 mm	200	1,38 \$	2095	16 x 210 mm	100	2,87 \$
2084	9 x 160 mm	200	1,35 \$	2096	18 x 210 mm	100	3,87 \$
2085	9 x 210 mm	200	1,58 \$	2097	20 x 210 mm	100	4,75 \$
2086	10 x 160 mm	200	1,34 \$				

Plastik askılıktadır.



SDS MAX MATKAP UÇLARI

◆ SDS Max Matkap Ucu - 4 Elmaslı



Kod	Özellikler	Koli	Fiyat	Kod	Özellikler	Koli	Fiyat
2099	12 x 340 mm	50	5,65 \$	2116	28 x 570 mm	30	20,00 \$
2099-1	12 x 540 mm	50	8,90 \$	2117	30 x 570 mm	25	21,60 \$
2100	14 x 340 mm	50	5,67 \$	2118	32 x 570 mm	30	28,00 \$
2100-1	14 x 540 mm	50	9,30 \$	2119	35 x 570 mm	25	30,00 \$
2101	16 x 340 mm	50	6,30 \$	2120	38 x 570 mm	20	37,00 \$
2102	16 x 540 mm	50	9,50 \$	2121	40 x 570 mm	20	47,00 \$
2103	18 x 340 mm	50	6,90 \$	2122	42 x 570 mm	10	55,00 \$
2104	18 x 540 mm	50	9,80 \$	2123	18 x 1000 mm	20	20,00 \$
2105	20 x 340 mm	50	7,40 \$	2124	20 x 1000 mm	20	21,00 \$
2106	20 x 520 mm	50	10,10 \$	2125	22 x 1000 mm	20	23,50 \$
2107	22 x 340 mm	50	8,00 \$	2126	24 x 1000 mm	20	27,00 \$
2108	22 x 520 mm	40	11,10 \$	2126-1	25 x 1000 mm	50	30,00 \$
2109	24 x 340 mm	40	11,00 \$	2127	26 x 1000 mm	20	32,50 \$
2110	24 x 520 mm	40	14,30 \$	2128	28 x 1000 mm	10	38,00 \$
2111	25 x 340 mm	40	11,30 \$	2129	30 x 1000 mm	10	45,00 \$
2112	25 x 520 mm	40	14,80 \$	2130	32 x 1000 mm	10	52,00 \$
2113	26 x 340 mm	40	13,20 \$	2131	35 x 1000 mm	5	61,00 \$
2114	26 x 520 mm	40	17,50 \$	2132	38 x 1000 mm	5	70,00 \$
2115	28 x 340 mm	30	14,70 \$	2133	40 x 1000 mm	5	90,00 \$

Dayanıklı plastik poşettedir.

◆ SDS Kalıpcı Matkap Ucu



Kod	Özellikler	Koli	Fiyat	Kod	Özellikler	Koli	Fiyat
2135	10 x 600 mm	50	3,60 \$	2139	18 x 600 mm	50	6,80 \$
2136	12 x 600 mm	50	4,40 \$	2140	20 x 600 mm	50	7,90 \$
2137	14 x 600 mm	50	5,50 \$	2141	22 x 600 mm	50	8,70 \$
2138	16 x 600 mm	50	5,70 \$	2142	24 x 600 mm	50	10,00 \$

Dayanıklı şeffaf plastik kutudadır.

◆ SDS Oluklu Keski

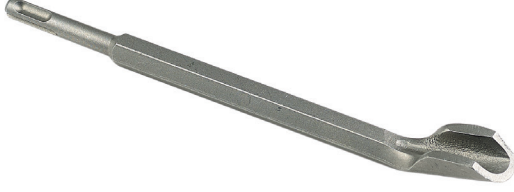

Kod	Özellikler	Koli	Fiyat
2145	14 x 250 mm	100	2,08 \$

Plastik askılıktadır.

◆ SDS Geniş Keski

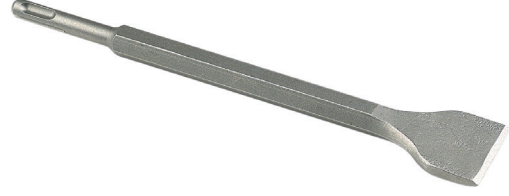

Kod	Özellikler	Koli	Fiyat
2146	14 x 40 x 250 mm	100	2,08 \$

Dayanıklı plastik poşettedir.

◆ SDS Plus Keski



Kod	Özellikler	Koli	Fiyat
2147	14 x 250 mm	100	1,60 \$

Dayanıklı plastik poşettedir.

◆ SDS Plus Murç

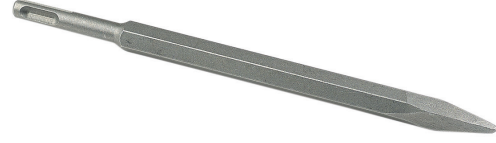

Kod	Özellikler	Koli	Fiyat
2148	14 x 250 mm	100	1,60 \$

Dayanıklı plastik poşettedir.

◆ SDS Max Keski

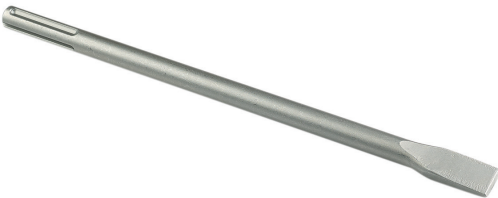

Kod	Özellikler	Koli	Fiyat
2150	18 x 400 mm	30	4,00 \$
2151	18 x 500 mm	20	4,85 \$
2152	18 x 600 mm	20	5,60 \$

Plastik kutudadır.

◆ SDS Max Murç



Kod	Özellikler	Koli	Fiyat
2153	18 x 400 mm	30	4,00 \$
2154	18 x 500 mm	20	4,85 \$
2155	18 x 600 mm	20	5,60 \$

Plastik kutudadır.

◆ SDS Max Geniş Keski

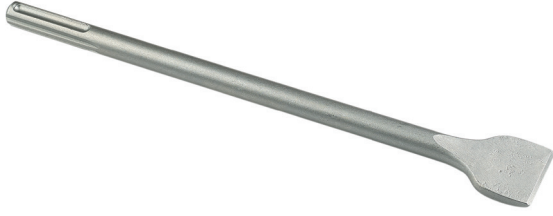

Kod	Özellikler	Koli	Fiyat
2156	18 x 50 X 400 mm	25	4,50 \$

Plastik askılıktadır.

◆ SDS Max Geniş Keski (Kısa)

YENİ ÜRÜN



Kod	Özellikler	Koli	Fiyat
2159	18 x 50 x 300 mm	25	4,25 \$

Plastik askılıktadır.

◆ 16 Kg Kırıclar İçin Keski



Kod	Özellikler	Koli	Fiyat
2157	26 x 410 x 35	10	12,50 \$

Plastik kutudadır.

◆ 16 Kg Kırıclar İçin Murç



Kod	Özellikler	Koli	Fiyat
2158	26 x 410	10	12,50 \$

Plastik kutudadır.

◆ SDS Ağaç Delme Matkap Ucu



Kod	Özellikler	Koli	Fiyat
2180	8 x 250 mm	200	1,60 \$
2181	10 x 250 mm	200	1,70 \$
2182	12 x 250 mm	200	1,89 \$
2183	14 x 250 mm	160	2,40 \$
2184	16 x 250 mm	160	2,80 \$
2185	18 x 250 mm	100	3,35 \$
2186	20 x 250 mm	100	3,90 \$
2187	22 x 250 mm	100	4,70 \$
2188	24 x 250 mm	100	5,80 \$
2189	8 x 500 mm	100	2,80 \$
2190	10 x 500 mm	100	2,90 \$
2191	12 x 500 mm	100	3,50 \$
2192	14 x 500 mm	80	4,26 \$
2193	16 x 500 mm	60	5,20 \$
2194	18 x 500 mm	60	6,15 \$
2195	20 x 500 mm	50	7,40 \$
2196	22 x 500 mm	50	8,80 \$
2197	24 x 500 mm	50	10,10 \$

Plastik askılıktadır.

◆ Ahşap Dekupaj Ağzı (5'li Paket)

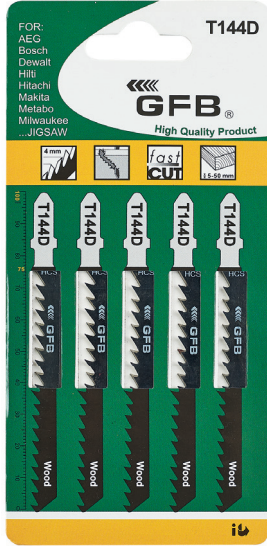

Kod	Özellikler	Paket	Koli	Fiyat
2240	T144 - D	100	400	2,05 \$
2241	T111 - C	100	400	1,37 \$
2242	T101 - D	100	400	2,77 \$
2243	T344 - D (Uzun)	100	400	2,85 \$

◆ Metal Dekupaj Ağzı (5'li Paket)

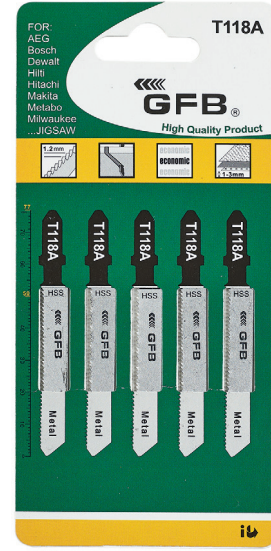

Kod	Özellikler	Paket	Koli	Fiyat
2250	T118 - A	100	400	3,35 \$
2251	T318 - A (Uzun)	100	400	6,25 \$

◆ Ytong Tuğla Kesme Tilki Kuyruğu (1'li Paket)



Kod	Özellikler	Paket	Koli	Fiyat
2281	S 1243 - HM	25	100	15,00 \$
2283	S 2243 - HM	25	100	22,00 \$

◆ Kemik Kesme Tilki Kuyruğu (5'li Paket)

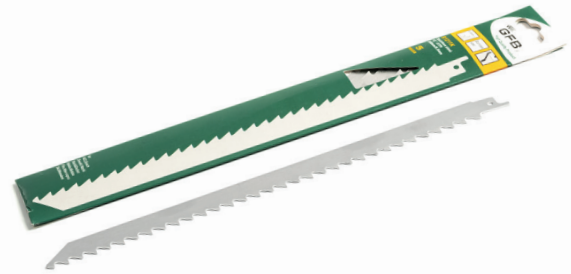

Kod	Özellikler	Paket	Koli	Fiyat
2282	S 1211 - K	20	100	10,50 \$

◆ Ahşap Tilki Kuyruğu (5'li Paket)



Kod	Özellikler	Paket	Koli	Fiyat
2260	S 1531 - L	20	100	8,70 \$

◆ Metal Tilki Kuyruğu (5'li Paket)



Kod	Özellikler	Paket	Koli	Fiyat
2270	S 922 - EF	20	100	7,90 \$

◆ Metal ve Ahşap Tilki Kuyruğu (5'li Paket)



Kod	Özellikler	Paket	Koli	Fiyat
2280	S 1122 - HF	20	100	10,50 \$

◆ Metal Tilki Kuyruğu - Uzun (5'li Paket)



Kod	Özellikler	Paket	Koli	Fiyat
2275	S 1122 - EF	20	100	12,00 \$

◆ HSS Havşa Matkap Ucu



Kod	Özellikler	Paket	Koli	Fiyat
2300	3,0 mm	25	200	2,18 \$
2301	3,5 mm	25	200	2,18 \$
2302	4,0 mm	25	200	2,18 \$

Dayanıklı plastik askılıklı kutudadır.

◆ Menteşe Yeri Açma Ucu



Kod	Özellikler	Paket	Koli	Fiyat
2303	18 mm	30	360	2,00 \$
2304	20 mm	30	360	2,30 \$
2305	22 mm	30	360	2,50 \$
2306	26 mm	30	360	2,80 \$
2307	35 mm	20	240	3,50 \$
2308	40 mm	12	144	3,90 \$
2309	45 mm	12	144	5,00 \$
2310	50 mm	8	96	5,50 \$
2311	54 mm	8	96	6,20 \$
2312	60 mm	6	72	6,60 \$
2313	65 mm	6	72	7,50 \$
2314	70 mm	5	60	8,50 \$

Dayanıklı plastik askılıklı kutudadır.

◆ Temizleme Bıçağı



Kod	Özellikler	Paket	Koli	Fiyat
2315	12 x 12,7 x 25,4 mm	25	300	3,10 \$

Dayanıklı plastik askılıklı kutudadır.



◆ Freze makinalarında kullanım için uygundur.

Kod	Özellikler	Paket	Koli	Fiyat
2316	35 mm	10	100	5,10 \$

Dayanıklı plastik askılıklı kutudadır.

◆ Yaprak Matkap Ucu Hex Saplı



Kod	Özellikler	Paket	Koli	Fiyat
2160	12 mm	50	400	0,99 \$
2161	14 mm	50	400	1,04 \$
2162	16 mm	50	400	1,11 \$
2163	18 mm	50	400	1,16 \$
2164	20 mm	50	400	1,24 \$
2165	22 mm	50	400	1,29 \$
2166	24 mm	50	400	1,34 \$
2167	30 mm	20	240	1,65 \$
2168	35 mm	50	300	1,80 \$
2169	38 mm	20	200	2,10 \$
2170	40 mm	20	240	2,30 \$

Blister Kartlıdır.

◆ Yaprak Matkap Ucu Seti (6 Parçalı)



◆ Set İçeriği : 12-16-18-20-22-24 mm

Kod	Özellikler	Paket	Koli	Fiyat
2171	6 Parçalı Set	25	100	5,50 \$

Blister Kartlıdır.

◆ Cam - Seramik Delme Üniversal Matkap Ucu



Kod	Özellikler	Paket	Fiyat
4600	4 mm	20	1,50 \$
4601	5 mm	20	1,50 \$
4602	6 mm	20	1,50 \$
4603	7 mm	20	1,90 \$
4604	8 mm	20	2,00 \$
4605	9 mm	20	2,45 \$
4606	10 mm	20	2,80 \$
4607	12 mm	20	3,40 \$
4608	14 mm	20	4,40 \$

HSS ALÜMİNYUM FREZE UÇLARI

GFB

40

◆ Alüminyum Freze Ucu (Normal Boy)



Kod	Özellikler	Paket	Fiyat
2400	5 x 8 x 80 mm	40	3,30 \$

◆ Alüminyum Freze Ucu (Uzun Boy)



Kod	Özellikler	Paket	Fiyat
2401	5 x 8 x 120 mm	10	4,45 \$

◆ Alüminyum Freze Ucu



Kod	Özellikler	Paket	Fiyat
2402	5 x 8 x 100 mm	10	4,35 \$

◆ Alüminyum Freze Ucu (Kısa)



Kod	Özellikler	Paket	Fiyat
2403	5 x 8 x 60 mm	40	2,75 \$

◆ Alüminyum Freze Ucu (HSS - E Cobalt)



Kod	Özellikler	Paket	Fiyat
2404	5 x 8 x 80 mm	40	6,25 \$

◆ Alüminyum Freze Ucu (Arkası İnce)



Kod	Özellikler	Paket	Fiyat
2405	5 x 6 x 80 mm	40	2,60 \$

◆ Alüminyum Freze Ucu (Arkası İnce Kısa)



Kod	Özellikler	Paket	Fiyat
2406	5 x 6 x 60 mm	40	2,50 \$

◆ Alüminyum Freze Ucu (Arkası İnce Uzun)



Kod	Özellikler	Paket	Fiyat
2407	5 x 6 x 100 mm	10	3,85 \$

◆ Alüminyum Freze Ucu (Arkası İnce Uzun)



Kod	Özellikler	Paket	Fiyat
2408	5 x 6 x 120 mm	10	4,00 \$

◆ Alüminyum Freze Ucu (Ucu Kalın)



Kod	Özellikler	Paket	Fiyat
2409	6 x 8 x 80 mm	40	3,40 \$

◆ Alüminyum Freze Ucu (Arkası Kalın Kısa)



Kod	Özellikler	Paket	Fiyat
2410	8 x 8 x 80 mm	10	3,55 \$

◆ Alüminyum Freze Ucu (Arkası Kalın Normal)



Kod	Özellikler	Paket	Fiyat
2411	8 x 8 x 100 mm	10	4,35 \$

◆ Alüminyum Freze Ucu (Arkası Kalın Uzun)



Kod	Özellikler	Paket	Fiyat
2412	8 x 8 x 120 mm	10	4,50 \$

◆ Alüminyum Freze Ucu (Ucu İnce)



Kod	Özellikler	Paket	Fiyat
2413	4 x 8 x 80 mm	40	3,45 \$

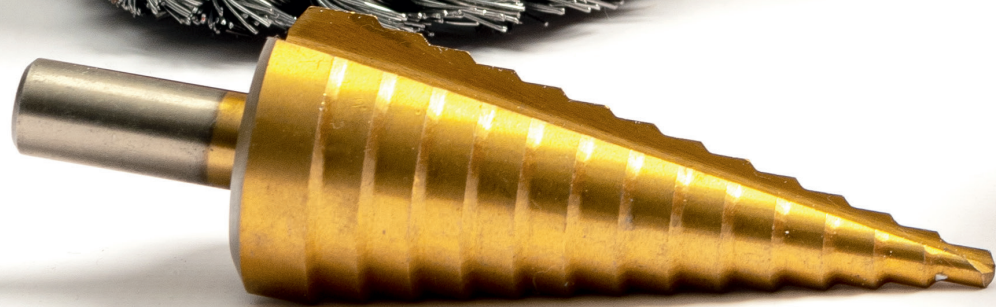

Kesiciler, Pançlar ve Fırçalar

- Flap Zımparalar
- Mermer Granit Kesiciler
- Sunta Elmas Testere
- Kesici ve Aşındırıcı Taşlar
- Elmaslı Beton Delme
- Panç ve Adaptörleri
- Bi - Metal Pançlar ve Adaptörleri
- TCT Metal Delme Pançları
- Mermer Granit Pançlar
- Kademeli Saç Delme Uçları
- Buat Açma Panç Seti
- Fırçalar
- Profesyonel Şerit Metre
- Eko Şerit Metre
- Köpük Tabancası
- Silikon - Epoksi Tabancaları

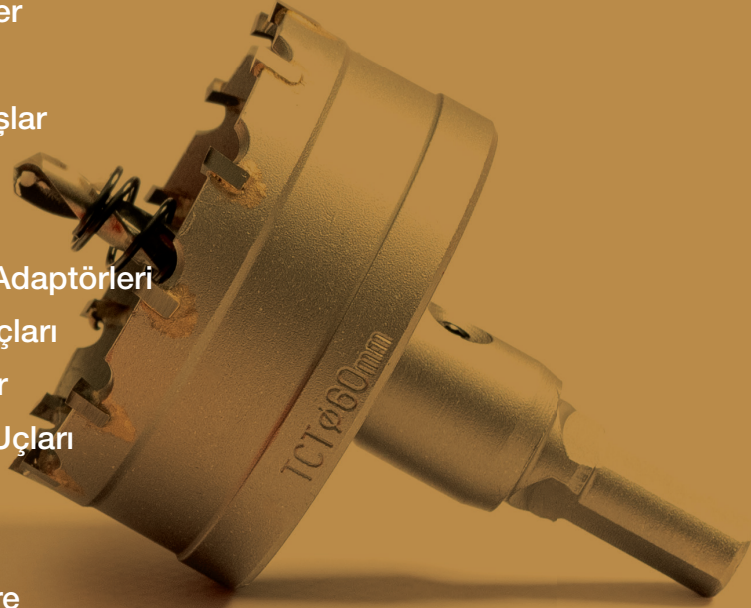

◆ Zirkonyum Flap Disk Zımpara



Kod	Özellikler	Paket	Koli	Fiyat
2321	115 mm 40 Kum	10	200	0,91 \$
2322	115 mm 60 Kum	10	200	0,91 \$
2323	115 mm 80 Kum	10	200	0,91 \$
2324	115 mm 100 Kum	10	200	0,91 \$
2325	115 mm 120 Kum	10	200	0,91 \$

◆ Alüminyum Flap Disk Zımpara



Kod	Özellikler	Paket	Koli	Fiyat
2326	115 mm 40 Kum	10	200	0,70 \$
2327	115 mm 60 Kum	10	200	0,70 \$
2328	115 mm 80 Kum	10	200	0,70 \$
2329	115 mm 100 Kum	10	200	0,70 \$
2330	115 mm 120 Kum	10	200	0,70 \$

◆ Sürekli Turbo Elmas Mermer - Granit Kesici



Kod	Özellikler	Paket	Koli	Fiyat
2380	115 mm	10	100	1,85 \$
2381	180 mm	1	50	4,90 \$
2382	230 mm	1	25	7,75 \$

Karton kutudadır.

◆ Turbo Elmas Mermer - Granit Kesici



Kod	Özellikler	Paket	Koli	Fiyat
2385	115 mm	10	100	2,20 \$
2386	180 mm	1	50	5,00 \$
2387	230 mm	1	25	8,35 \$

Karton kutudadır.

◆ Soketli Elmas Beton - Mermer Kesici



Kod	Özellikler	Paket	Koli	Fiyat
2388	115 mm	10	100	2,00 \$
2389	180 mm	1	50	4,80 \$
2390	230 mm	1	25	8,00 \$

Karton kutudadır.

◆ Hassas Kesim İnce Turbo Elmas Seramik - Fayans Kesici



Kod	Özellikler	Paket	Koli	Fiyat
2391	115 x 1,2 mm	1	100	6,50 \$
2392	125 x 1,3 mm	1	100	7,50 \$
2393	180 x 1,6 mm	1	40	12,00 \$

Plastik blister ambalajdadır.

◆ Hassas Kesim İnce Turbo Elmas Seramik - Fayans Kesici



Kod	Özellikler	Paket	Koli	Fiyat
2394	115 mm Çapraz Diş	1	100	7,10 \$

Plastik blister ambalajdadır.

◆ Sunta Elmas Testere



Kod	Özellikler	Paket	Koli	Fiyat
2370	115 x 40T x 22.23mm	1	100	3,10 \$
2371	180 x 40T x 22.23mm	1	50	5,30 \$
2372	185 x 40T x 30.00mm	1	50	6,10 \$
2373	190 x 40T x 30.00mm	1	50	6,70 \$
2374	210 x 40T x 30.00mm	1	25	7,50 \$
2375	230 x 40T x 30.00mm	1	25	10,00 \$
2376	300 x 40T x 30.00mm	1	25	19,00 \$
2377	350 x 40T x 30.00mm	1	10	27,00 \$

Plastik blister ambalajdadır.

◆ INOX Kesici Taş



Kod	Özellikler	Paket	Koli	Fiyat
2350	115 x 1,0 x 22,23	50	600	0,32 \$
2350-1	125 x 1,0 x 22,23	50	600	0,44 \$
2351	180 x 1,6 x 22,23	50	200	0,85 \$

Karton - Plastik kutudadır.

◆ Metal Kesme Taş



Kod	Özellikler	Paket	Koli	Fiyat
2355	115 x 2,5 x 22,23	25	200	0,53 \$
2356	180 x 3,0 x 22,23	25	100	1,04 \$
2357	230 x 3,0 x 22,23	25	50	1,50 \$
2358	300 x 3,0 x 25,40	5	25	2,70 \$
2359	355 x 3,0 x 25,40	5	25	3,30 \$

Karton kutudadır.

◆ Metal Taşlama Taşı



Kod	Özellikler	Paket	Koli	Fiyat
2360	115 x 6 x 22,23	10	100	0,82 \$
2361	180 x 8 x 22,23	10	50	2,20 \$

Karton kutudadır.

◆ Elmaslı Beton Delme Panç (Adaptörlü)



Kod	Özellikler	Koli	Fiyat
2200	30 mm	20	6,30 \$
2201	35 mm	20	6,70 \$
2202	40 mm	20	7,20 \$
2203	45 mm	20	7,30 \$
2204	50 mm	20	7,60 \$
2205	55 mm	20	7,90 \$
2206	60 mm	20	8,35 \$
2207	65 mm	20	8,70 \$
2208	70 mm	20	9,40 \$
2209	75 mm	20	10,20 \$
2210	80 mm	20	11,00 \$
2211	100 mm	10	18,00 \$
2212	110 mm	10	20,00 \$
2213	120 mm	10	24,00 \$
2214	125 mm	10	28,00 \$

Karton kutudadır.

◆ Elmaslı Beton Delme Panç (Adaptörsüz)



Kod	Özellikler	Koli	Fiyat
2215	30 mm	50	4,60 \$
2216	35 mm	50	5,00 \$
2217	40 mm	50	5,35 \$
2218	45 mm	50	5,60 \$
2219	50 mm	50	6,10 \$
2220	55 mm	50	6,25 \$
2221	60 mm	50	6,70 \$
2222	65 mm	50	7,20 \$
2223	70 mm	40	7,95 \$
2224	75 mm	40	8,80 \$
2225	80 mm	40	9,70 \$
2226	100 mm	20	16,40 \$
2227	110 mm	20	18,00 \$
2227-1	115 mm	10	20,00 \$
2228	120 mm	10	21,80 \$
2229	125 mm	10	25,00 \$

Plastik kutudadır.

◆ SDS Plus - SDS Max Panç Adaptörü



Kod	Özellikler	Koli	Fiyat
2230	200 mm	50	4,35 \$
2231	250 mm	50	6,50 \$
2232	350 mm	20	7,80 \$
2235	250 mm Max	50	6,60 \$
2236	350 mm Max	20	8,40 \$

Plastik askılıktadır.

◆ Bi - Metal Panç



Kod	Özellikler	Fiyat
4800	16 mm	1,87 \$
4801	17 mm	1,95 \$
4802	19 mm	2,10 \$
4803	20 mm	2,20 \$
4804	22 mm	2,40 \$
4805	25 mm	2,75 \$
4806	28 mm	3,05 \$
4807	30 mm	3,30 \$
4808	32 mm	3,50 \$
4809	35 mm	3,85 \$
4810	38 mm	3,95 \$
4811	40 mm	4,10 \$
4812	41 mm	4,25 \$
4813	44 mm	4,50 \$
4814	46 mm	4,70 \$
4815	48 mm	4,90 \$
4816	51 mm	5,20 \$
4817	54 mm	5,45 \$
4818	57 mm	5,70 \$
4819	60 mm	6,15 \$
4820	63 mm	6,60 \$
4820-1	64 mm	6,75 \$
4821	65 mm	6,95 \$
4822	68 mm	7,15 \$
4823	70 mm	7,30 \$
4824	73 mm	7,55 \$

Kod	Özellikler	Fiyat
4825	76 mm	7,80 \$
4826	79 mm	8,20 \$
4827	83 mm	8,50 \$
4828	86 mm	8,90 \$
4829	89 mm	9,15 \$
4830	92 mm	9,50 \$
4831	95 mm	9,75 \$
4832	98 mm	10,00 \$
4833	102 mm	10,30 \$
4834	105 mm	10,70 \$
4835	108 mm	11,00 \$
4836	111 mm	11,55 \$
4837	114 mm	11,80 \$
4838	121 mm	12,35 \$
4839	127 mm	12,95 \$
4840	133 mm	13,60 \$
4841	140 mm	14,35 \$
4842	146 mm	15,00 \$
4843	152 mm	15,60 \$
4844	160 mm	16,60 \$
4845	168 mm	17,20 \$
4846	178 mm	18,50 \$
4847	200 mm	21,00 \$
4848	210 mm	24,15 \$

Karton kutudadır.

◆ Bi-Metal Panç Merkezleme Ucu

YENİ
ÜRÜN

Kod	Özellikler	Paket	Fiyat
4864	6,3 mm x 72 mm	10	0,85 \$

TCT METAL PANÇ ve ADAPTÖRLER

◆ Bi - Metal Panç Adaptörü - HEX



Kod	Özellikler	Koli	Fiyat
4860	14 - 29 mm	200	2,15 \$
4861	30 - 210 mm	100	4,95 \$

Karton kutudadır.

◆ Bi - Metal Panç Adaptörü - SDS



Kod	Özellikler	Koli	Fiyat
4862	14 - 29 mm	200	2,30 \$
4863	30 - 210 mm	100	5,00 \$

Karton kutudadır.

◆ TCT Metal Delme Panç



◆ Uzunluk 75 mm

Kod	Özellikler	Paket	Koli	Fiyat
4700	16 mm	10	300	2,55 \$
4701	18 mm	10	340	2,75 \$
4702	19 mm	10	340	3,00 \$
4703	20 mm	10	340	3,10 \$
4704	22 mm	10	300	3,37 \$
4705	25 mm	10	250	3,70 \$
4706	28 mm	10	300	4,20 \$
4707	30 mm	10	180	4,55 \$
4708	32 mm	10	180	4,70 \$
4709	35 mm	10	180	5,25 \$
4710	38 mm	10	120	5,90 \$
4711	40 mm	10	120	6,20 \$
4712	44 mm	6	72	6,75 \$
4713	48 mm	6	72	7,45 \$
4714	50 mm	6	72	7,55 \$
4715	54 mm	6	72	8,35 \$
4716	60 mm	6	72	8,95 \$
4716-1	64 mm	6	72	9,50 \$
4717	65 mm	4	48	9,75 \$
4718	70 mm	4	48	10,60 \$
4719	75 mm	4	48	12,57 \$
4720	80 mm	1	27	14,25 \$
4721	85 mm	1	27	15,85 \$
4722	90 mm	1	27	16,65 \$
4723	95 mm	1	27	18,95 \$
4724	100 mm	1	36	28,75 \$
4725	110 mm	1	24	29,40 \$
4726	120 mm	1	24	31,55 \$

Plastik Kutudadır.

◆ Vakumlu Mermer - Granit Delme Panç



Plastik kutudadır.

Kod	Özellikler	Paket	Fiyat
4870	12 mm	1	10,60 \$
4871	14 mm	1	10,80 \$
4872	16 mm	1	11,00 \$
4873	18 mm	1	12,50 \$
4874	20 mm	1	14,00 \$
4875	22 mm	1	15,50 \$
4876	25 mm	1	17,00 \$
4877	28 mm	1	20,00 \$
4878	33 mm	1	23,00 \$
4879	35 mm	1	23,30 \$
4880	38 mm	1	29,00 \$
4880-1	42 mm	1	30,00 \$
4881	45 mm	1	33,20 \$
4882	52 mm	1	39,50 \$
4883	57 mm	1	42,00 \$
4884	63 mm	1	48,00 \$

◆ Mermer - Granit Panç - M14



Kod	Özellikler	Paket	Koli	Fiyat
4885	12 mm	10	100	8,40 \$
4886	16 mm	10	100	10,70 \$
4887	18 mm	10	100	11,90 \$
4888	20 mm	10	100	13,00 \$
4889	22 mm	10	100	14,50 \$
4890	25 mm	10	100	15,90 \$
4891	33 mm	10	50	20,00 \$
4892	34 mm	10	50	21,00 \$

Plastik blister ambalaj - Sulu delme önerilir.
Spiral (avuç taşlama) matkapta kullanım için uygundur.

◆ Mermer -Granit Delme Panç - HEX



Kod	Özellikler	Paket	Koli	Fiyat
4893	12 mm	10	100	8,20 \$
4894	18 mm	10	100	11,70 \$
4895	20 mm	10	100	12,80 \$

Plastik blister ambalaj - Sulu delme önerilir.
Normal matkaplarda kullanım için uygundur.

KADEMELİ MATKAP UCU ve BUAT SET

◆ Kademeli Matkap Ucu Tekli

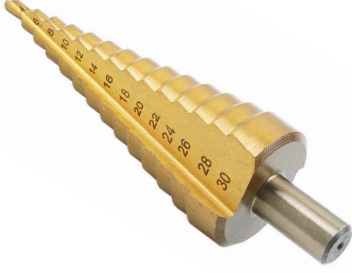

Kod	Özellikler	Paket	Koli	Fiyat
2420	4 - 12 mm	10	90	3,00 \$
2421	4 - 20 mm	10	90	4,40 \$
2422	4 - 30 mm	6	54	8,00 \$
2423	4 - 32 mm	6	54	8,80 \$
2424	4 - 39 mm	5	45	16,50 \$
2425	6 - 52 mm	4	36	25,50 \$

Blister Kartlıdır.

◆ Kademeli Matkap Ucu Seti



Kod	Özellikler	Paket	Koli	Fiyat
2426	4-12, 4-20, 4-32	1	30	17,80 \$

Metal kutudadır.

◆ Buat Açma Pauç Seti

YENİ
ÜRÜN



- ◆ 8 Parçalı Set İçeriği : 64-76-89-102-127 mm
- ◆ 11 Parçalı Set İçeriği : 19-22-28-32-38-44-51
64 mm
- ◆ 16 Parçalı Set İçeriği : 19-22-28-32-38-44-51
64-76-89-102-127 mm

Kod	Özellikler	Paket	Koli	Fiyat
4855	8 Pcs Set	1	30	5,90 \$
4856	11 Pcs Set	1	40	4,80 \$
4857	16 Pcs Set	1	30	9,00 \$

Plastik kutudadır.

◆ Burgulu Çanak Fırça



Kod	Özellikler	Paket	Koli	Fiyat
5130	65 mm	1	100	1,75 \$
5131	75 mm	1	100	1,90 \$
5132	100 mm	1	60	3,10 \$

◆ Saçaklı Çanak Fırça



Kod	Özellikler	Paket	Koli	Fiyat
5140	65 mm	1	100	1,40 \$
5141	75 mm	1	100	1,50 \$
5142	100 mm	1	60	2,35 \$

◆ Saçaklı Daire Fırça



Kod	Özellikler	Paket	Koli	Fiyat
5150	125 mm	1	60	3,60 \$
5151	150 mm	1	40	5,15 \$
5152	175 mm	1	30	6,10 \$
5153	200 mm	1	30	6,90 \$

◆ Pimli Daire Fırça



Kod	Özellikler	Paket	Koli	Fiyat
5160	50 mm	70	840	0,70 \$
5161	65 mm	45	540	0,75 \$
5162	75 mm	30	360	0,86 \$
5163	100 mm	15	180	1,30 \$

◆ Pimli Kalem Fırça



Kod	Özellikler	Paket	Koli	Fiyat
5170	12 mm	125	1500	0,42 \$
5171	17 mm	70	840	0,56 \$
5172	25 mm	75	450	0,70 \$
5173	30 mm	50	300	1,00 \$

◆ Pimli Çanak Fırça



Kod	Özellikler	Paket	Koli	Fiyat
5180	50 mm	30	360	0,99 \$
5181	65 mm	20	240	1,20 \$
5182	75 mm	15	180	1,40 \$

◆ Pimli Tel Fırça Seti - 6 Parçalı



- ◆ Pimli daire 40 - 50 - 75 - 100 mm
- ◆ Pimli kalem 25 mm
- ◆ Pimli Çanak 50 mm

Kod	Özellikler	Paket	Koli	Fiyat
5125	6 Parçalı	1	40	5,35 \$

◆ Plastik Saplı Tel Fırça



Kod	Özellikler	Paket	Koli	Fiyat
5126	Plastik Saplı	12	120	1,05 \$

◆ Profesyonel Şerit Metre



Seperatörlü karton kutudadır.

- ◆ İki stoplu mekanizma
- ◆ Sıfır konumlu siyah kanca
- ◆ Darbeye dayanıklı ABS kasa
- ◆ Uzun mesafeli dik durma
- ◆ EEC II ve MID sertifikalı

Kod	Özellikler	Paket	Koli	Fiyat
5100	3 x 16 mm	12	120	2,20 \$
5101	5 x 19 mm	12	120	3,35 \$
5102	5 x 25 mm	12	96	4,00 \$
5104	8 x 25 mm	12	48	6,50 \$
5103	10 x 25 mm	12	48	7,50 \$

◆ Eko Şerit Metre

YENİ ÜRÜN



- ◆ Stop (Durdurma) mekanizma özelliği
- ◆ Sıfır konumlu metal kanca
- ◆ Darbeye dayanıklı ABS kasa
- ◆ Uzun mesafeli dik durma
- ◆ EEC II ve MID sertifikalı
- ◆ Avuç içi ve parmaklara uyumlu rahat tutuş

Kod	Özellikler	Paket	Koli	Fiyat
5115	5 x 25 mm	12	96	3,00 \$

◆ Köpük Tabancası



Kod	Özellikler	Paket	Koli	Fiyat
5120	Köpük Tabancası	1	40	10,60 \$

Dayanıklı karton kutudadır.

◆ Profesyonel Alüminyum Silikon Tabanca

YENİ ÜRÜN



Kod	Özellikler	Paket	Koli	Fiyat
5121	Alüminyum	1	30	7,00 \$

◆ Profesyonel Alüminyum Epoksi Tabanca 345ml.

YENİ ÜRÜN



Kod	Özellikler	Paket	Koli	Fiyat
5122	345ml.	1	30	7,30 \$

◆ Profesyonel Plastik Gövde Sosis Tabanca 600ml.

YENİ ÜRÜN



◆ Sosis Tabanca Plastik Başlık

Kod	Özellikler	Paket	Koli	Fiyat
5119	600ml.	1	20	10,20 \$

◆ Profesyonel Plastik Gövde Epoksi Tabanca 410ml.

YENİ ÜRÜN



Kod	Özellikler	Paket	Koli	Fiyat
5123	410ml.	1	20	10,00 \$





Maket Bıçakları

- Metal Maket Bıçakları
- Plastik Maket Bıçakları
- Maket Bıçak Yedekleri



◆ Metal Maket Bıçağı Pro



Kod	Özellikler	Paket	Koli	Fiyat
4500	18 mm Pro	24	192	1,75 \$

◆ Metal Maket Bıçağı Kırmızı - Siyah



Kod	Özellikler	Paket	Koli	Fiyat
4501	18 mm	24	288	2,10 \$

◆ Metal Maket Bıçağı Eko



Kod	Özellikler	Paket	Koli	Fiyat
4502	18 mm Eko	24	288	1,90 \$

◆ Plastik Maket Bıçağı



Kod	Özellikler	Paket	Koli	Fiyat
4510	18 mm	24	432	0,64 \$

◆ Plastik Maket Bıçağı Pro



Kod	Özellikler	Paket	Koli	Fiyat
4504	18 mm Pro	36	288	1,30 \$

◆ Metal Maket Bıçağı Küçük



Kod	Özellikler	Paket	Koli	Fiyat
4505	9 mm	30	180	2,00 \$

MAKET BİÇAKLARI YEDEKLERİ

◆ Maket Bıçağı Yedeği 18 x 0,5 mm



Kod	Özellikler	Paket	Koli	Fiyat
4520	0,5 mm - 7 Kırımlı	100	4000	0,075 \$
4521	0,5 mm - 14 Kırımlı	100	4000	0,075 \$

◆ Maket Bıçağı Yedeği 18 x 0,5 mm SK5 - Pro

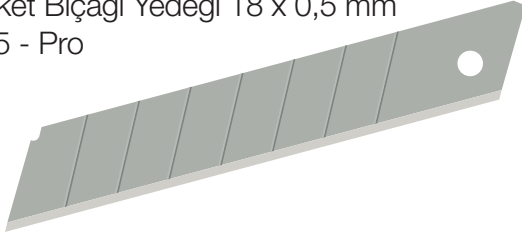

Kod	Özellikler	Paket	Koli	Fiyat
4522	18 x 0,5 mm	100	4000	0,095 \$

◆ Maket Bıçağı Yedeği 18 x 0,5 mm Kırımsız

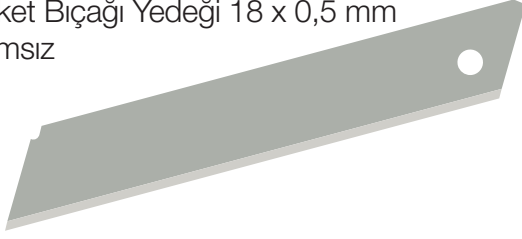

◆ İş güvenlik maket bıçakları için uygundur.

Kod	Özellikler	Paket	Koli	Fiyat
4523	18 x 0,5 mm	100	4000	0,080 \$

◆ Kintex Maket Bıçağı Yedeği 18 x 0,4 mm

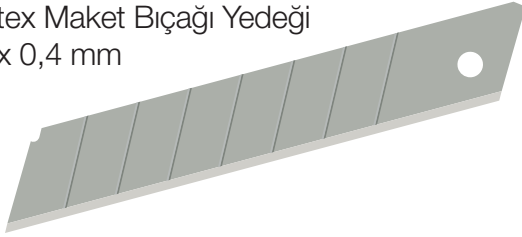

Kod	Özellikler	Paket	Koli	Fiyat
4524	18 x 0,4 mm	100	4000	0,062 \$

◆ Maket Bıçağı Yedeği Dar 9 x 0,4 mm

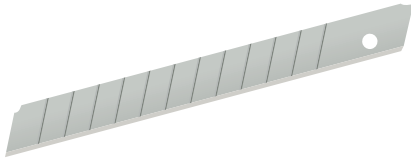

Kod	Özellikler	Paket	Koli	Fiyat
4525	9 x 0,4 mm	100	10000	0,060 \$

◆ Trapezoid Bıçağı Yedeği 19 x 0,6 mm

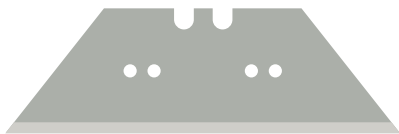

Kod	Özellikler	Paket	Koli	Fiyat
4526	19 x 0,6 mm	100	1000	0,10 \$

◆ İş güvenlik maket bıçakları için uygundur.





Tornavida Uçları

- Kare Bits Uçlar
- Yuvarlak Bits Uçlar
- Allen Bits Uç
- 1/2" Lokmalı Bits Uçlar
- Tork Otomotiv Bits Uç
- Allen Otomotiv Bits Uç
- Bits Uzatma Adaptörleri
- Şapkalı Yıldız Bits Uç
- Bükülebilir Bits Uzatma
- Manyetik Somun Lokmaları
- Lokma Adaptörleri
- Otomotiv Bits Uç Seti

◆ Kare Yıldız Bits Uç

YENİ ÜRÜN



Kod	Özellikler	Paket	Koli	Fiyat
5200	PH 1 x 50 mm	30	1800	0,23 \$
5201	PH 1 x 75 mm	20	1200	0,37 \$
5202	PH 1 x 100 mm	10	600	0,64 \$
5203	PH 1 x 150 mm	10	600	0,88 \$
5205	PH 2 x 25 mm	60	3600	0,13 \$
5206	PH 2 x 50 mm	30	1800	0,23 \$
5207	PH 2 x 75 mm	20	1200	0,37 \$
5208	PH 2 x 100 mm	10	600	0,64 \$
5209	PH2 x 110 mm	10	600	0,88 \$
5210	PH2 x 150 mm	10	600	0,88 \$
5211	PH2 x 197 mm	10	400	1,35 \$
5212	PH2 x 200 mm	10	400	1,35 \$
5215	PH3 x 50 mm	30	1800	0,23 \$
5216	PH3 x 75 mm	20	1200	0,37 \$

◆ Kare Pozi Bits Uç

YENİ ÜRÜN



Kod	Özellikler	Paket	Koli	Fiyat
5220	PZ 1 x 50 mm	30	1800	0,23 \$
5221	PZ 1 x 75 mm	20	1200	0,37 \$
5225	PZ 2 x 25 mm	60	3600	0,13 \$
5226	PZ 2 x 50 mm	30	1800	0,23 \$
5227	PZ 2 x 75 mm	20	1200	0,37 \$
5228	PZ 2 x 100 mm	10	600	0,64 \$
5229	PZ 2 x 150 mm	10	600	0,88 \$
5230	PZ3 x 50 mm	30	1800	0,23 \$
5231	PZ3 x 75 mm	20	1200	0,37 \$

◆ Kare Düz Bits Uç

YENİ ÜRÜN



Kod	Özellikler	Paket	Koli	Fiyat
5250	SL 6 x 25 mm	60	3600	0,13 \$
5251	SL 6 x 50 mm	30	1800	0,23 \$
5252	SL 6 x 75 mm	20	1200	0,37 \$

◆ Kare Tork Bits Uç

YENİ ÜRÜN



Kod	Özellikler	Paket	Koli	Fiyat
5240	T 30 x 30 mm	60	3600	0,16 \$
5241	T 30 x 50 mm	30	1800	0,23 \$
5242	T 30 x 75 mm	20	1200	0,37 \$
5243	T 30 x 100 mm	10	600	0,64 \$
5244	T 30 x 150 mm	10	600	0,88 \$
5235	T 10 x 50 mm	30	1800	0,23 \$
5236	T 15 x 50 mm	30	1800	0,23 \$
5237	T 20 x 50 mm	30	1800	0,23 \$
5238	T 25 x 50 mm	30	1800	0,23 \$
5239	T 27 x 50 mm	30	1800	0,23 \$

◆ Yuvarlak Yıldız Bits Uç



Kod	Özellikler	Paket	Koli	Fiyat
2508	PH 1 x 50 mm	30	1800	0,29 \$
2509	PH 1 x 75 mm	20	1350	0,46 \$
2510	PH 1 x 100 mm	10	1000	0,85 \$
2511	PH 1 x 150 mm	10	600	1,43 \$
2500	PH 2 x 25 mm	60	3600	0,16 \$
2501	PH 2 x 50 mm	50	2000	0,29 \$
2502	PH 2 x 75 mm	50	1350	0,46 \$
2503	PH 2 x 100 mm	10	1000	0,85 \$
2504	PH2 x 110 mm	10	1000	1,43 \$
2505	PH2 x 150 mm	10	600	1,43 \$
2506	PH2 x 197 mm	10	500	2,11 \$
2507	PH2 x 200 mm	10	500	2,11 \$
2498	PH3 x 50 mm	30	1800	0,31 \$
2499	PH3 x 75 mm	20	1200	0,46 \$

◆ Yuvarlak Pozi Bits Uç



Kod	Özellikler	Paket	Koli	Fiyat
2512	PZ 1 x 50 mm	30	1800	0,31 \$
2513	PZ 1 x 75 mm	20	1200	0,49 \$
2514	PZ 2 x 25 mm	60	3600	0,16 \$
2515	PZ 2 x 50 mm	30	2000	0,31 \$
2516	PZ 2 x 75 mm	50	1350	0,49 \$
2517	PZ 2 x 100 mm	10	600	0,86 \$
2518	PZ 2 x 150 mm	10	600	1,46 \$
2496	PZ3 x 50 mm	30	1800	0,31 \$
2497	PZ3 x 75 mm	20	1200	0,49 \$

◆ Yuvarlak Düz Bits Uç

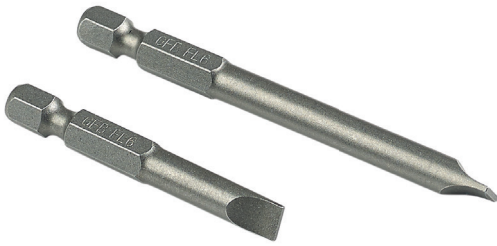

Kod	Özellikler	Paket	Koli	Fiyat
2530	SL 6 x 25 mm	60	4200	0,16 \$
2531	SL 6 x 50 mm	30	1800	0,29 \$
2532	SL 6 x 75 mm	20	1350	0,46 \$

◆ Yuvarlak Tork Bits Uç

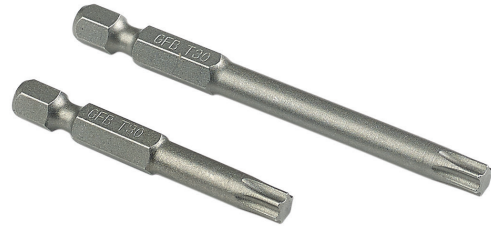

Kod	Özellikler	Paket	Koli	Fiyat
2520	T 30 x 30 mm	50	3000	0,16 \$
2521	T 30 x 50 mm	30	1800	0,31 \$
2522	T 30 x 75 mm	20	1200	0,46 \$
2523	T 30 x 100 mm	10	500	0,86 \$
2524	T 30 x 150 mm	10	500	1,46 \$
2525	T 10 x 50 mm	30	1800	0,31 \$
2526	T 15 x 50 mm	30	1800	0,31 \$
2527	T 20 x 50 mm	30	1800	0,31 \$
2528	T 25 x 50 mm	30	1800	0,31 \$
2529	T 27 x 50 mm	30	1800	0,31 \$

◆ Allen Standart Bits Uç



Kod	Özellikler	Paket	Koli	Fiyat
2480	HEX3 - 50	30	1800	0,27 \$
2481	HEX4 - 50	30	1800	0,27 \$
2482	HEX5 - 50	30	1800	0,27 \$
2483	HEX6 - 50	30	1800	0,27 \$

Plastik kutudadır.

◆ 1/2" Tork Lokmalı Bits Uç Kısa



Kod	Özellikler	Paket	Koli	Fiyat
2430	T20 - 55	10	240	2,15 \$
2431	T25 - 55	10	240	2,15 \$
2432	T27 - 55	10	240	2,15 \$
2433	T30 - 55	10	240	2,15 \$
2434	T35 - 55	10	240	2,15 \$
2435	T40 - 55	10	240	2,15 \$
2436	T45 - 55	10	240	2,15 \$
2437	T50 - 55	10	240	2,15 \$
2438	T55 - 55	10	240	2,15 \$
2439	T60 - 55	10	240	2,45 \$

◆ 1/2" Allen Lokmalı Bits Uç Kısa

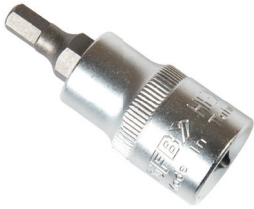

Kod	Özellikler	Paket	Koli	Fiyat
2440	HEX4 - 55	10	240	2,15 \$
2441	HEX5 - 55	10	240	2,15 \$
2442	HEX6 - 55	10	240	2,15 \$
2443	HEX7 - 55	10	240	2,15 \$
2444	HEX8 - 55	10	240	2,15 \$
2445	HEX10 - 55	10	240	2,15 \$
2446	HEX12 - 55	10	240	2,15 \$
2447	HEX14 - 55	10	240	2,45 \$

◆ 1/2" Allen Lokmalı Bits Uç Uzun



Kod	Özellikler	Paket	Koli	Fiyat
2448	HEX4 - 100	10	160	2,55 \$
2449	HEX5 - 100	10	160	2,55 \$
2450	HEX6 - 100	10	160	2,55 \$
2451	HEX8 - 100	10	160	2,55 \$
2452	HEX10 - 100	10	160	2,55 \$
2453	HEX12 - 100	10	160	3,20 \$

◆ Tork Otomotiv Bits Uç Kısa



Kod	Özellikler	Paket	Koli	Fiyat
2454	T20 - 30	20	1200	0,55 \$
2455	T25 - 30	20	1200	0,55 \$
2456	T30 - 30	20	1200	0,55 \$
2457	T40 - 30	20	1200	0,55 \$
2458	T45 - 30	20	1200	0,55 \$
2459	T50 - 30	20	1200	0,55 \$
2460	T55 - 30	20	1200	0,55 \$

◆ Tork Otomotiv Bits Uç Uzun



Kod	Özellikler	Paket	Koli	Fiyat
2461	T20 - 75	8	480	1,05 \$
2462	T25 - 75	8	480	1,05 \$
2463	T30 - 75	8	480	1,05 \$
2464	T40 - 75	8	480	1,05 \$
2465	T45 - 75	8	480	1,05 \$
2466	T50 - 75	8	480	1,05 \$
2467	T55 - 75	8	480	1,05 \$

◆ Allen Otomotiv Bits Uç Kısa



Kod	Özellikler	Paket	Koli	Fiyat
2468	HEX5 - 30	20	1200	0,55 \$
2469	HEX6 - 30	20	1200	0,55 \$
2470	HEX7 - 30	20	1200	0,55 \$
2471	HEX8 - 30	20	1200	0,55 \$
2472	HEX10 - 30	20	1200	0,55 \$
2473	HEX12 - 30	20	900	0,70 \$

◆ Allen Otomotiv Bits Uç Uzun



Kod	Özellikler	Paket	Koli	Fiyat
2474	HEX5 - 75	8	480	1,05 \$
2475	HEX6 - 75	8	480	1,05 \$
2476	HEX7 - 75	8	480	1,05 \$
2477	HEX8 - 75	8	480	1,05 \$
2478	HEX10 - 75	8	360	1,05 \$
2479	HEX12 - 75	8	344	1,35 \$

◆ Manyetik Bits Uzatma Adaptörü (Çin)



Kod	Özellikler	Kutu	Paket	Fiyat
2560	60 mm	10	100	0,40 \$
2561	100 mm	5	50	0,65 \$
2562	150 mm	5	50	0,85 \$

◆ SDS Bits Ara Adaptörü (Çin)



Kod	Özellikler	Kutu	Paket	Fiyat
2556	SDS Bits Ara Adaptörü	1	50	0,90 \$

◆ Manyetik Bits Uzatma Adaptörü (Taiwan)



Kod	Özellikler	Paket	Koli	Fiyat
2555	10 x 60 mm	50	1000	1,50 \$

Kaliteli CR-V çeliğinden üretilmiştir. Made in Taiwan

◆ Şapkalı Bits Uç (Çin)



Kod	Özellikler	Kutu	Paket	Fiyat
2557	PH2 x 25 mm	10	100	0,24 \$

◆ Manyetik Somun Lokması (Çin)



Kod	Özellikler	Paket	Koli	Fiyat
2545	7 x 45 mm	50	500	0,40 \$
2546	8 x 45 mm	50	500	0,40 \$
2547	10 x 45 mm	50	500	0,45 \$
2548	11 x 45 mm	50	500	0,56 \$
2549	12 x 45 mm	50	500	0,56 \$
2550	13 x 45 mm	50	500	0,58 \$
2551	8 x 65 mm Uzun	50	500	0,45 \$
2552	14 x 65 mm	30	300	1,00 \$
2553	17 x 65 mm	30	300	2,00 \$

Kaliteli CR-V çeliğinden üretilmiştir. Askılıklı plastik kutudadır.

◆ Manyetik Somun Lokması Ekstra Uzun (Çin)



Kod	Özellikler	Kutu	Paket	Fiyat
2554	8 x 150 (Ekstra Uzun)	5	50	2,20 \$

Kaliteli CR-V çeliğinden üretilmiştir. Askılıklı plastik kutudadır.

◆ Bükülebilir Bits Uzatma



Kod	Özellikler	Paket	Koli	Fiyat
2535	12"	36	144	4,00 \$

Blister Kartlıdır. Made in Taiwan

◆ Manyetik Somun Lokması (Taiwan)



Kod	Özellikler	Paket	Koli	Fiyat
2540	8 x 45 mm	50	1000	1,20 \$
2541	10 x 45 mm	50	500	1,35 \$
2542	13 x 45 mm	30	600	1,60 \$

Kaliteli CR-V çeliğinden üretilmiştir. Made in Taiwan

◆ SDS Lokma Adaptörü



Kod	Özellikler	Kutu	Paket	Fiyat
2563	1/2 x 73 SDS	4	40	1,50 \$
2564	1/4 x 65 SDS	10	100	1,40 \$

◆ HEX Lokma Adaptörü



Kod	Özellikler	Kutu	Paket	Fiyat
2565	1/2 x 73 HEX	4	40	1,20 \$
2566	1/4 x 65 HEX	10	100	0,75 \$

◆ 40 Parçalı Otomotiv Bits Uç Seti

YENİ
ÜRÜN

Kod	Özellikler	Kutu	Koli	Fiyat
5260	40 Pcs Bits Set	1	10	36,50 \$



Torna Aynaları ve Tutucular

- Torna Aynaları
- Torna Ayna Yedek Parçaları
- Döner Punta
- Mors Konik
- Mors Kovan
- Mandrenler
- Mandren Anahtarları ve Adaptörleri
- ER Pensler
- OZ Pensler
- Pens Setleri
- Pens Başlıkları
- Çektirme Vidaları
- Er Kapaklar
- Er Anahtarlar



◆ Torna Aynası 3 Ayak

SAN DU
 C H U C K

Kod	Özellikler	Fiyat
2598	K 11 - 50/3	77,00 \$
2599	K 11 - 63/3	90,00 \$
2600	K 11 - 80/3	76,00 \$
2601	K 11 - 100/3	84,00 \$
2602	K 11 - 125/3	94,00 \$
2603	K 11 - 160/3	138,00 \$
2604	K 11 - 200/3	193,00 \$
2605	K 11 - 250/3	260,00 \$
2606	K 11 - 315/3	525,00 \$
2607	K 11 - 400/3	825,00 \$
2608	K 11 - 500/3	1550,00 \$
2609	K 11 - 630/3	4550,00 \$

Karton ve tahta kutudadır.

◆ Torna Aynası 4 Ayak



SAN DU
 C H U C K

Kod	Özellikler	Fiyat
2650	K 12 - 100/4	113,00 \$
2651	K 12 - 125/4	120,00 \$
2652	K 12 - 160/4	172,00 \$
2653	K 12 - 200/4	230,00 \$
2654	K 12 - 250/4	325,00 \$
2655	K 12 - 315/4	610,00 \$
2655-1	K 12 - 400/4	960,00 \$
2655-2	K 12 - 500/4	1.840,00 \$
2655-3	K 12 - 630/4	5.200,00 \$

Karton ve tahta kutudadır.

◆ İmalat Ayaklı Torna Aynası 3 Ayak

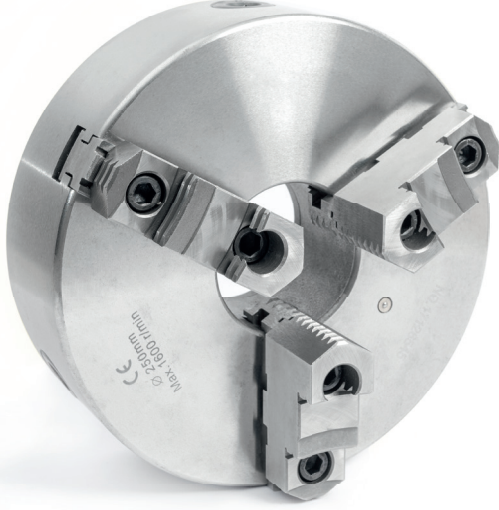
YENİ
ÜRÜN



SAN OU
C H U C K

Kod	Özellikler	Fiyat
2610	K 11 - 160/3	170,00 \$
2611	K 11 - 200/3	220,00 \$
2612	K 11 - 250/3	310,00 \$
2613	K 11 - 315/3	590,00 \$
2614	K 11 - 400/3	860,00 \$
2615	K 11 - 500/3	1.600,00 \$
2616	K 11 - 630/3	4.400,00 \$

Karton ve tahta kutudadır.

◆ İmalat Ayaklı Torna Aynası 4 Ayak

YENİ
ÜRÜN



SAN OU
C H U C K

Kod	Özellikler	Fiyat
2620	K 12 - 160/4	218,00 \$
2621	K 12 - 200/4	295,00 \$
2622	K 12 - 250/4	380,00 \$
2623	K 12 - 315/4	699,00 \$
2624	K 12 - 400/4	1.100,00 \$
2625	K 12 - 500/4	1.790,00 \$
2626	K 12 - 630/4	5.400,00 \$

Karton ve tahta kutudadır.

◆ Divizör Torna Aynası 3 Ayak

YENİ
ÜRÜNSAN OU
C H U C K

Kod	Özellikler	Fiyat
2630	K 11 - 160/3	180,00 \$
2631	K 11 - 200/3	249,00 \$
2632	K 11 - 250/3	325,00 \$
2633	K 11 - 315/3	610,00 \$
2634	K 11 - 400/3	900,00 \$
2635	K 11 - 500/3	1.695,00 \$
2636	K 11 - 630/3	5.200,00 \$

Karton ve tahta kutudadır.

◆ Divizör Torna Aynası 4 Ayak

YENİ
ÜRÜNSAN OU
C H U C K

Kod	Özellikler	Fiyat
2640	K 12 - 160/4	218,00 \$
2641	K 12 - 200/4	318,00 \$
2642	K 12 - 250/4	425,00 \$
2643	K 12 - 315/4	735,00 \$
2644	K 12 - 400/4	1.380,00 \$
2645	K 12 - 500/4	1.900,00 \$
2646	K 12 - 630/4	6.050,00 \$

Karton ve tahta kutudadır.

◆ 3 Ayak Düz - Ters Takım

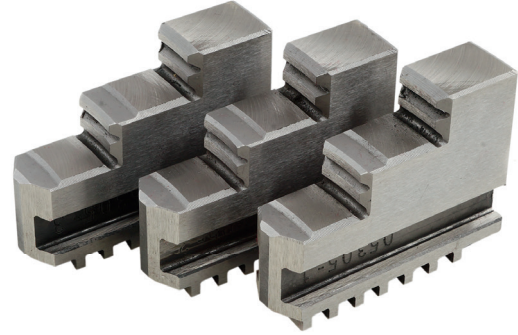
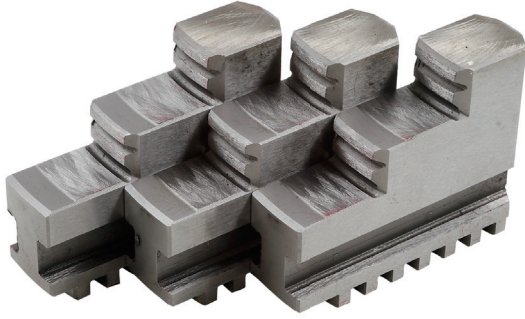
SAN DU
 C H U C K

Kod	Özellikler	Fiyat
2656	80/3 Düz	26,00 \$
2657	100/3 Düz	30,00 \$
2658	125/3 Düz	32,00 \$
2659	160/3 Düz	36,00 \$
2660	200/3 Düz	48,00 \$
2661	250/3 Düz	63,00 \$
2662	315/3 Düz	127,00 \$
2663	400/3 Düz	132,00 \$
2664	500/3 Düz	248,00 \$

Kod	Özellikler	Fiyat
2667	80/3 Ters	26,00 \$
2668	100/3 Ters	30,00 \$
2669	125/3 Ters	32,00 \$
2670	160/3 Ters	36,00 \$
2671	200/3 Ters	48,00 \$
2672	250/3 Ters	63,00 \$
2673	315/3 Ters	127,00 \$
2674	400/3 Ters	132,00 \$
2675	500/3 Ters	248,00 \$

◆ 4 Ayak Düz - Ters Takım

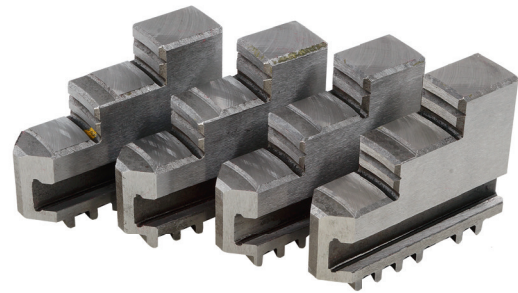
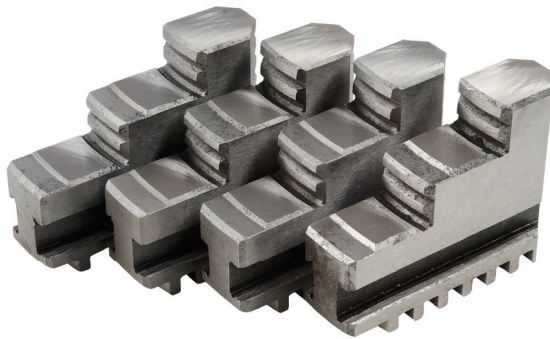
SAN DU
 C H U C K

Kod	Özellikler	Fiyat
2676	100/4 Düz	35,00 \$
2677	125/4 Düz	40,00 \$
2678	160/4 Düz	48,00 \$
2679	200/4 Düz	62,00 \$
2680	250/4 Düz	82,00 \$
2681	315/4 Düz	148,00 \$
2682	100/4 Ters	35,00 \$

Kod	Özellikler	Fiyat
2683	125/4 Ters	40,00 \$
2684	160/4 Ters	48,00 \$
2685	200/4 Ters	62,00 \$
2686	250/4 Ters	82,00 \$
2687	315/4 Ters	148,00 \$
2687-2	500/4 Ters	260,00 \$

◆ Pinyon

SAN OU
 C H U C K

Kod	Özellikler	Fiyat
2688	80 Ø	6,00 \$
2689	100 Ø	7,00 \$
2690	125 Ø	8,00 \$
2691	160 Ø	9,00 \$
2692	200 Ø	10,00 \$
2693	250 Ø	11,00 \$
2694	315 Ø	13,00 \$
2695	400 Ø	19,00 \$
2696	500 Ø	28,00 \$

◆ Spiral Dişlisi

SAN OU
 C H U C K

Kod	Özellikler	Fiyat
2697	80 Ø	20,00 \$
2698	100 Ø	23,00 \$
2699	125 Ø	30,00 \$
2700	160 Ø	42,00 \$
2701	200 Ø	58,00 \$
2702	250 Ø	85,00 \$
2703	315 Ø	140,00 \$
2704	400 Ø	290,00 \$
2705	500 Ø	320,00 \$

◆ Anahtar

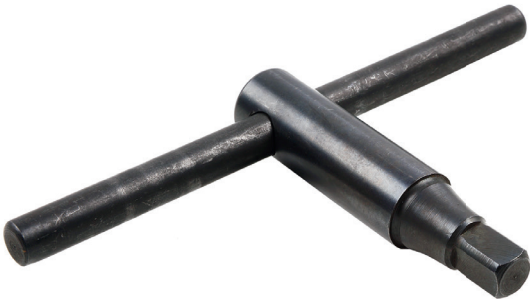
SAN OU
 C H U C K

Kod	Özellikler	Fiyat
2706	80 Ø	6,50 \$
2707	100 Ø	6,50 \$
2708	125 Ø	9,50 \$
2709	160 Ø	12,50 \$
2710	200 Ø	16,00 \$
2711	250 Ø	16,00 \$
2712	315 Ø	20,00 \$
2713	400 Ø	27,00 \$
2714	500 Ø	29,00 \$

◆ Döner Punta



Kod	Özellikler	Uzunluk	Fiyat
2749	1 MORS	115 mm	21,00 \$
2750	2 MORS	130 mm	27,00 \$
2751	3 MORS	170 mm	34,00 \$
2752	4 MORS	210 mm	42,00 \$
2753	5 MORS	268 mm	58,00 \$

Köpüklü karton kutudadır.

77

◆ Mors Konik



Kod	Özellikler	Uzunluk	Fiyat
2760	10/2 MORS	101 mm	3,25 \$
2761	12/3 MORS	124 mm	4,60 \$
2762	16/2 MORS	112 mm	3,50 \$
2763	16/3 MORS	131 mm	4,10 \$
2764	16/4 MORS	156 mm	6,40 \$
2765	18/2 MORS	120 mm	3,30 \$
2766	18/3 MORS	139 mm	4,00 \$
2767	18/4 MORS	164 mm	6,70 \$
2768	22/2 MORS	128 mm	6,60 \$
2769	22/3 MORS	147 mm	5,20 \$
2770	22/4 MORS	172 mm	6,80 \$
2771	24/4 MORS	181 mm	8,30 \$

Plastik kutudadır.

◆ Mors Kovan



Kod	Özellikler	Uzunluk	Fiyat
2780	3 x 2	108 mm	4,50 \$
2781	4 x 1	124 mm	7,60 \$
2782	4 x 2	124 mm	7,60 \$
2783	4 x 3	122 mm	7,60 \$
2784	5 x 2	156 mm	16,00 \$
2785	5 x 3	156 mm	16,00 \$
2786	5 x 4	164 mm	16,00 \$

Plastik kutudadır.

◆ Anahtarlı Mandren



Kod	Özellikler	Koli	Fiyat
2715	1,5 - 10 mm 1/2 - 20	100	2,70 \$
2716	1,5 - 10 mm 3/8 - 24	100	2,70 \$
2717	1,5 - 13 mm 1/2 - 20	50	3,10 \$
2718	1,5 - 13 mm 3/8 - 24	50	3,10 \$
2719	3,0 - 16 mm 1/2 - 20	30	6,00 \$

Karton kutudadır.

◆ Konik Anahtarlı Mandren



Kod	Özellikler	Koli	Fiyat
2720	1,0 - 10 mm B12	50	8,50 \$
2721	1,0 - 13 mm B16	50	10,00 \$
2722	1,0 - 16 mm B18	30	10,80 \$
2723	5,0 - 20 mm B22	20	18,00 \$

Karton kutudadır.

◆ Supra Elle Sıkma Mandren



Kod	Özellikler	Koli	Fiyat
2724	1,0 - 10 mm B12	20	22,00 \$
2725	1,0 - 13 mm B16	20	24,00 \$
2726	1,0 - 16 mm B16	20	30,50 \$
2727	1,0 - 16 mm B18	20	30,50 \$
2728	5,0 - 20 mm B22	20	46,00 \$

Karton kutudadır.

◆ Supra Plastik Mandren



Kod	Özellikler	Koli	Fiyat
2730	0,8 - 10 mm 1/2 - 20	50	2,50 \$
2731	0,8 - 10 mm 3/8 - 24	50	2,50 \$
2732	2,0 - 13 mm 1/2 - 20	50	3,90 \$
2733	2,0 - 13 mm 3/8 - 24	50	3,90 \$

Karton kutudadır.

◆ Supra Kilitli Mandren



Kod	Özellikler	Koli	Fiyat
2741	1,5 - 10 mm 3/8 - 24	50	8,45 \$
2742	1,5 - 13 mm 1/2 - 20	50	10,50 \$

Karton kutudadır.

◆ Mini Mandren



Kod	Özellikler	Paket	Fiyat
2745	0,5 - 3,5 mm Küçük	125	5,10 \$
2746	0,5 - 6 mm Büyük	50	5,70 \$

B blister kartlıdır.

◆ Mandren Anahtar



Kod	Özellikler	Koli	Fiyat
2790	10 - 13 mm	500	0,53 \$
2791	16 mm	300	0,83 \$
2792	20 mm	100	1,25 \$

Plastik poşetlidir.

◆ SDS Plus Mandren Adaptörü



Kod	Özellikler	Koli	Fiyat
2795	1/2 - 20 mm	250	0,80 \$
2796	3/8 - 24 mm	250	0,80 \$

Plastik kutudadır.

◆ ER 11 Pensler



Kod	Özellikler	Kutu	Fiyat
4900	ER 11 - 3	10	4,10 \$
4901	ER 11 - 4	10	4,10 \$
4902	ER 11 - 5	10	4,10 \$
4903	ER 11 - 6	10	4,10 \$

Plastik kutudadır.

◆ ER 16 Pensler



Kod	Özellikler	Kutu	Fiyat
4910	ER 16 - 3	10	3,50 \$
4911	ER 16 - 4	10	3,50 \$
4912	ER 16 - 5	10	3,50 \$
4913	ER 16 - 6	10	3,50 \$
4914	ER 16 - 8	10	3,50 \$
4915	ER 16 - 10	10	3,50 \$

Plastik kutudadır.

◆ ER 20 Pensler



Kod	Özellikler	Kutu	Fiyat
4920	ER 20 - 3	10	3,60 \$
4921	ER 20 - 4	10	3,60 \$
4922	ER 20 - 5	10	3,60 \$
4923	ER 20 - 6	10	3,60 \$
4924	ER 20 - 8	10	3,60 \$
4925	ER 20 - 10	10	3,60 \$
4926	ER 20 - 12	10	3,60 \$

Plastik kutudadır.

◆ ER 25 Pensler



Kod	Özellikler	Kutu	Fiyat
4930	ER 25 - 3	10	4,00 \$
4931	ER 25 - 4	10	4,00 \$
4932	ER 25 - 5	10	4,00 \$
4933	ER 25 - 6	10	4,00 \$
4934	ER 25 - 8	10	4,00 \$
4935	ER 25 - 10	10	4,00 \$
4936	ER 25 - 12	10	4,00 \$
4937	ER 25 - 14	10	4,00 \$
4938	ER 25 - 16	10	4,00 \$

Plastik kutudadır.

◆ ER 32 PENSLER



Kod	Özellikler	Kutu	Fiyat
4940	ER 32 - 3	10	4,80 \$
4941	ER 32 - 4	10	4,80 \$
4942	ER 32 - 5	10	4,80 \$
4943	ER 32 - 6	10	4,80 \$
4944	ER 32 - 8	10	4,80 \$
4945	ER 32 - 10	10	4,80 \$
4946	ER 32 - 12	10	4,80 \$
4947	ER 32 - 14	10	4,80 \$
4948	ER 32 - 16	10	4,80 \$
4949	ER 32 - 18	10	4,80 \$
4950	ER 32 - 20	10	4,80 \$

Plastik kutudadır.

◆ ER 40 PENSLER



Kod	Özellikler	Kutu	Fiyat
4955	ER 40 - 3	10	6,60 \$
4956	ER 40 - 4	10	6,60 \$
4957	ER 40 - 5	10	6,60 \$
4958	ER 40 - 6	10	6,60 \$
4959	ER 40 - 8	10	6,60 \$
4960	ER 40 - 10	10	6,60 \$
4961	ER 40 - 12	10	6,60 \$
4962	ER 40 - 14	10	6,60 \$
4963	ER 40 - 16	10	6,60 \$
4964	ER 40 - 18	10	6,60 \$
4965	ER 40 - 20	10	6,60 \$
4966	ER 40 - 22	10	6,60 \$
4967	ER 40 - 25	10	6,60 \$

Plastik kutudadır.

◆ OZ 25 Pensler



Kod	Özellikler	Kutu	Fiyat
4970	OZ 25 - 3	10	6,60 \$
4971	OZ 25 - 4	10	6,60 \$
4972	OZ 25 - 5	10	6,60 \$
4973	OZ 25 - 6	10	6,60 \$
4974	OZ 25 - 8	10	6,60 \$
4975	OZ 25 - 10	10	6,60 \$
4976	OZ 25 - 12	10	6,60 \$
4977	OZ 25 - 14	10	6,60 \$
4978	OZ 25 - 16	10	6,60 \$
4979	OZ 25 - 18	10	6,60 \$
4980	OZ 25 - 20	10	6,60 \$
4981	OZ 25 - 22	10	6,60 \$
4982	OZ 25 - 24	10	6,60 \$
4983	OZ 25 - 25	10	6,60 \$

Plastik kutudadır.

◆ Pens Setleri



Kod	Özellikler	Fiyat
4985	ER 11 - 5 PCS / 3 - 7 mm	31,00 \$
4986	ER 16 - 8 PCS / 3 - 10 mm	36,00 \$
4987	ER 20 - 11 PCS / 3 - 13 mm	50,00 \$
4988	ER 25 - 15 PCS / 3 - 16 mm	74,00 \$
4989	ER 32 - 18 PCS / 3 - 20 mm	94,00 \$
4990	ER 40 - 23 PCS / 3 - 26 mm	160,00 \$

Plastik kutudadır.

◆ Pens Başlığı



Kod	Özellikler	Fiyat
5000	BT 40 - ER16 - 100	39,00 \$
5001	BT 40 - ER25 - 100	39,00 \$
5002	BT 40 - ER32 - 100	39,00 \$
5003	BT 40 - ER40 - 100	44,00 \$

Plastik kutudadır.

◆ Çektirme Civatası



Kod	Özellikler	Paket	Fiyat
5010	BT 30 - 45 °	1	4,00 \$
5011	BT 40 - 45 °	1	4,50 \$
5012	BT 50 - 45 °	1	7,50 \$

Plastik kutudadır.

◆ ER Kapak



Kod	Özellikler	Paket	Fiyat
5020	ER 25 UM	1	6,00 \$
5021	ER 32 UM	1	7,00 \$
5022	ER 40 UM	1	8,00 \$

Karton kutudadır.

◆ ER Anahtar



Kod	Özellikler	Paket	Fiyat
5030	ER 25 UM	1	5,00 \$
5031	ER 32 UM	1	6,00 \$
5032	ER 40 UM	1	7,00 \$

Plastik şeffaf poşettedir.



Kesici Takımlar

- HSS Standart Parmak Freze
- HSS Uzun Parmak Freze
- HSS Titan Kaplı Parmak Freze
- HSS Kabatlaş Parmak Freze
- HSS İki Ağızlı Parmak Freze
- Karbür Elmas Freze
- Karbür Küre Elmas Freze
- Torna ve Keski Kalemleri
- HSS Havşa Freze
- HSS Punta Uçları
- HSS Punta Çürütme Ucu

◆ HSS 4 Ağızlı Standart Freze



Kod	Ölçü	Kesme	Tam Boy	Şaft	Fiyat
2800	3,0 mm	8	52	6	3,25 \$
2801	4,0 mm	11	52	6	3,25 \$
2802	5,0 mm	13	57	6	3,45 \$
2803	6,0 mm	13	57	6	3,45 \$
2804	7,0 mm	16	66	10	5,20 \$
2805	8,0 mm	19	69	10	5,20 \$
2806	9,0 mm	19	69	10	6,60 \$
2807	10,0 mm	22	72	10	6,70 \$
2808	11,0 mm	22	79	12	8,60 \$
2809	12,0 mm	26	83	12	9,10 \$
2810	13,0 mm	26	83	12	10,10 \$
2811	14,0 mm	26	83	12	10,90 \$
2812	15,0 mm	26	83	12	12,00 \$
2813	16,0 mm	32	92	16	12,30 \$
2814	17,0 mm	32	92	16	13,60 \$
2815	18,0 mm	32	92	16	14,40 \$
2816	19,0 mm	32	92	16	19,35 \$
2817	20,0 mm	38	104	20	19,50 \$
2817-1	21,0 mm	38	104	20	23,00 \$
2818	22,0 mm	38	104	20	23,00 \$
2818-1	23,0 mm	38	104	20	30,00 \$
2819	24,0 mm	45	121	25	30,70 \$
2820	25,0 mm	45	121	25	31,00 \$
2821	26,0 mm	45	121	25	38,00 \$
2821-1	27,0 mm	45	121	25	41,00 \$
2822	28,0 mm	45	121	25	42,00 \$
2822-1	29,0 mm	45	121	25	44,00 \$
2823	30,0 mm	45	121	25	45,80 \$
2824	32,0 mm	53	133	32	53,30 \$
2825	35,0 mm	53	133	32	80,00 \$
2826	36,0 mm	53	133	32	80,00 \$
2827	38,0 mm	63	155	32	86,00 \$
2828	40,0 mm	63	155	40	125,00 \$

Dayanıklı plastik kutudadır.

◆ HSS 4 Ağızlı Uzun Freze



Kod	Ölçü	Kesme	Tam Boy	Şaft	Fiyat
2850	3,0 mm	12	56	6	4,10 \$
2851	4,0 mm	19	63	6	4,10 \$
2852	5,0 mm	24	68	6	4,50 \$
2853	6,0 mm	24	68	6	4,50 \$
2854	8,0 mm	38	88	10	7,65 \$
2855	10,0 mm	45	95	10	8,00 \$
2856	12,0 mm	53	110	12	12,35 \$
2857	14,0 mm	53	110	12	14,70 \$
2858	16,0 mm	63	123	16	18,00 \$
2859	18,0 mm	63	123	16	20,70 \$
2860	20,0 mm	75	141	20	27,75 \$
2861	22,0 mm	75	141	20	32,25 \$
2862	24,0 mm	90	166	25	44,10 \$
2863	25,0 mm	90	166	25	44,70 \$
2864	28,0 mm	90	166	25	63,60 \$
2865	30,0 mm	90	166	25	64,00 \$
2866	32,0 mm	106	186	32	70,80 \$

Dayanıklı plastik kutudadır.

◆ HSS 4 Ağızlı Titan Kaplı Freze



Kod	Ölçü	Kesme	Tam Boy	Şaft	Fiyat
2900	3,0 mm	8	52	6	4,30 \$
2901	4,0 mm	11	52	6	4,30 \$
2902	5,0 mm	13	57	6	4,60 \$
2903	6,0 mm	13	57	6	4,60 \$
2904	8,0 mm	19	69	10	6,20 \$
2905	10,0 mm	22	72	10	8,00 \$
2906	12,0 mm	26	83	12	11,00 \$
2907	14,0 mm	26	83	12	13,20 \$
2908	16,0 mm	32	92	16	15,20 \$
2909	18,0 mm	32	92	16	17,40 \$
2910	20,0 mm	38	104	20	22,50 \$
2911	22,0 mm	38	104	20	27,00 \$
2912	24,0 mm	45	121	25	35,00 \$
2913	25,0 mm	45	121	25	35,00 \$
2914	28,0 mm	45	121	25	46,00 \$
2915	30,0 mm	45	121	25	50,00 \$
2916	32,0 mm	53	133	32	54,00 \$

Dayanıklı plastik kutudadır.

◆ HSS 4 Ağızlı Kabatalaş Freze



Kod	Ölçü	Kesme	Tam Boy	Şaft	Fiyat
2950	6,0 mm	13	57	6	9,50 \$
2951	7,0 mm	16	66	10	10,00 \$
2952	8,0 mm	19	69	8	10,30 \$
2953	10,0 mm	22	72	10	11,50 \$
2954	12,0 mm	26	83	12	13,50 \$
2955	14,0 mm	26	83	12	16,70 \$
2956	16,0 mm	32	92	16	18,50 \$
2957	18,0 mm	32	92	16	22,00 \$
2958	20,0 mm	38	104	20	25,50 \$
2959	22,0 mm	38	104	20	37,30 \$
2960	25,0 mm	45	121	25	45,00 \$
2961	28,0 mm	45	121	25	58,00 \$
2962	30,0 mm	45	121	25	67,00 \$
2963	32,0 mm	53	133	32	75,00 \$
2964	34,0 mm	53	133	32	85,00 \$
2965	35,0 mm	53	133	32	88,00 \$

Dayanıklı plastik kutudadır.

◆ HSS 2 Ağızlı Freze



Kod	Ölçü	Kesme	Tam Boy	Şaft	Fiyat
3000	3,0 mm	7	51	6	3,30 \$
3001	4,0 mm	7	51	6	3,30 \$
3002	5,0 mm	8	52	6	3,45 \$
3003	6,0 mm	8	52	6	3,45 \$
3004	8,0 mm	11	61	10	4,85 \$
3005	10,0 mm	13	63	10	6,60 \$
3006	12,0 mm	16	73	12	8,50 \$
3007	14,0 mm	16	73	12	10,20 \$
3008	16,0 mm	19	79	16	11,70 \$
3009	18,0 mm	19	79	16	13,50 \$
3010	20,0 mm	22	88	20	17,50 \$
3011	22,0 mm	22	88	20	21,50 \$

Dayanıklı plastik kutudadır.

◆ 4 Ağızlı Karbür Elmas Freze



Kod	Ölçü	Kesme	Tam Boy	Şaft	Fiyat
3050	1,0 mm	10	50	4	3,70 \$
3051	1,5 mm	10	50	4	3,70 \$
3052	2,0 mm	10	50	4	3,70 \$
3053	2,5 mm	10	50	4	3,70 \$
3054	3,0 mm	10	50	3	3,70 \$
3055	4,0 mm	12	50	4	3,70 \$
3056	5,0 mm	15	50	5	6,80 \$
3057	6,0 mm	15	57	6	7,80 \$
3058	7,0 mm	20	60	8	12,00 \$
3059	8,0 mm	20	63	8	12,50 \$
3060	9,0 mm	25	67	10	19,00 \$
3061	10,0 mm	25	75	10	19,00 \$
3062	11,0 mm	25	75	11	25,00 \$
3063	12,0 mm	25	75	12	26,00 \$
3064	13,0 mm	25	83	14	46,00 \$
3065	14,0 mm	40	100	14	48,00 \$
3066	16,0 mm	45	100	16	59,00 \$
3067	18,0 mm	50	100	18	70,00 \$
3068	20,0 mm	50	100	20	95,00 \$

Dayanıklı plastik kutudadır.

◆ 4 Ağızlı Karbür Küresel Elmas Freze



Kod	Ölçü	Kesme	Tam Boy	Şaft	Fiyat
3080	3,0 mm	10	50	3	6,00 \$
3081	4,0 mm	12	50	4	6,00 \$
3082	5,0 mm	15	50	5	10,00 \$
3083	6,0 mm	15	50	6	10,00 \$
3084	8,0 mm	20	60	8	17,00 \$
3085	10,0 mm	25	70	10	24,00 \$
3086	12,0 mm	25	70	12	32,00 \$
3087	14,0 mm	30	80	14	63,00 \$
3088	16,0 mm	35	90	16	75,00 \$

Dayanıklı plastik kutudadır.

◆ HSS Torna Kalemi - 4 Köşeli



Kod	Özellikler	Paket	Fiyat
3100	6 x 6 x 200 mm	40	1,80 \$
3101	8 x 8 x 150 mm	20	2,35 \$
3102	8 x 8 x 200 mm	20	3,00 \$
3103	10 x 10 x 150 mm	15	3,50 \$
3104	10 x 10 x 200 mm	15	4,60 \$
3105	12 x 12 x 150 mm	10	5,00 \$
3106	12 x 12 x 200 mm	10	6,00 \$
3107	14 x 14 x 200 mm	8	8,00 \$
3108	16 x 16 x 200 mm	6	10,50 \$
3109	18 x 18 x 200 mm	3	13,50 \$
3110	20 x 20 x 200 mm	3	17,00 \$

◆ HSS Trapez Keski Kalemi (Zavyeli)



Kod	Özellikler	Paket	Fiyat
3160	1/2 - 3 x 4 x 160 mm	36	4,00 \$
3161	5/8 - 3 x 4 x 160 mm	30	5,00 \$
3162	3/4 - 3 x 4 x 160 mm	25	6,00 \$
3163	7/8 - 3 x 4 x 160 mm	20	7,00 \$

◆ HSS Torna Keski Kalemi - Yassı



Kod	Özellikler	Paket	Fiyat
3150	1/2 - 4 x 160 mm	30	2,30 \$
3151	5/8 - 4 x 160 mm	25	2,90 \$
3152	3/4 - 4 x 160 mm	20	3,30 \$
3153	7/8 - 4 x 160 mm	20	4,10 \$

◆ HSS Patograf Kalemi (Yuvarlak)



Kod	Özellikler	Paket	Fiyat
3170	6 x 160 mm	40	1,40 \$
3171	8 x 160 mm	20	2,30 \$
3172	10 x 160 mm	15	3,60 \$
3173	12 x 160 mm	10	5,10 \$

◆ HSS Havşa Freze 90 Derece



Kod	Özellikler	Paket	Fiyat
3174	8,3 mm	1	4,60 \$
3175	10,4 mm	1	5,40 \$
3176	12,4 mm	1	5,90 \$
3177	16,0 mm	1	6,80 \$
3178	16,5 mm	1	6,80 \$
3179	20,0 mm	1	8,60 \$
3180	20,5 mm	1	8,90 \$
3181	25,0 mm	1	12,40 \$
3182	25,5 mm	1	12,40 \$
3183	30,0 mm	1	18,35 \$
3184	31,5 mm	1	19,35 \$
3185	35,0 mm	1	27,00 \$
3186	40,0 mm	1	31,00 \$
3187	50,0 mm	1	47,00 \$

Dayanıklılık plastik kutudadır.

◆ HSS Punta Ucu



Kod	Özellikler	Paket	Fiyat
3198	1,6 mm	10	1,20 \$
3199	2,0 mm	10	1,30 \$
3200	2,5 mm	10	1,60 \$
3201	3,15 mm	10	1,85 \$
3202	4,0 mm	10	2,55 \$
3203	5,0 mm	5	4,55 \$
3204	6,3 mm	5	8,00 \$
3205	8,0 mm	1	16,00 \$
3206	10,0 mm	1	23,00 \$

Dayanıklılık plastik kutudadır.

◆ HSS Punta Çürütme



Kod	Özellikler	Paket	Fiyat
3188	6,0 * 66 mm	10	2,50 \$
3189	7,0 * 74 mm	10	2,90 \$
3190	8,0 * 79 mm	10	4,00 \$
3191	10,0 * 79 mm	10	6,00 \$

Dayanıklılık plastik kutudadır.

◆ HSS Punta Ucu Uzun



Kod	Özellikler	Paket	Fiyat
3192	2,0 mm	1	3,00 \$
3193	2,5 mm	1	3,20 \$
3194	3,15 mm	1	4,30 \$
3195	4,0 mm	1	6,20 \$
3196	5,0 mm	1	9,50 \$
3197	6,3 mm	1	15,50 \$

Dayanıklılık plastik kutudadır.



28X06

B1225X06

G1225X06

M1225X06





Karbür Kalıpcı Freze

- A - Silindir Düz
- B - Silindir Alın Kesmeli
- C - Silindir Oval Başlı
- D - Küre Başlı
- E - Oval Gövdeli
- F - Küre Uçlu Çam
- G - Sivri Çam
- H - Alev
- L - Konik Yuvarlak
- M - Konik Sivri

◆ A - Silindir Düz



Kod	Özellikler	Çap	Kesme Boyu	Boy	Arka Şaft	Fiyat
3210	A06 X16 X 06	6	16	65	6	4,00 \$
3211	A08 X 20 X 06	8	20	65	6	5,30 \$
3212	A10 X 20 X 06	10	20	65	6	6,60 \$
3213	A12 X 25 X 06	12	25	65	6	10,00 \$
3214	A16 X 25 X 06	16	25	65	6	17,50 \$

◆ B -Silindir Alın Kesmeli



Kod	Özellikler	Çap	Kesme Boyu	Boy	Arka Şaft	Fiyat
3215	B06 X16 X 06	6	16	65	6	4,00 \$
3216	B08 X 20 X 06	8	20	65	6	5,30 \$
3217	B10 X 20 X 06	10	20	65	6	6,60 \$
3218	B12 X 25 X 06	12	25	65	6	10,00 \$
3219	B16 X 25 X 06	16	25	65	6	17,50 \$

◆ C - Silindir Oval Başlı



Kod	Özellikler	Çap	Kesme Boyu	Boy	Arka Şaft	Fiyat
3220	C06 X16 X 06	6	16	65	6	4,00 \$
3221	C08 X 20 X 06	8	20	65	6	5,30 \$
3222	C10 X 20 X 06	10	20	65	6	6,60 \$
3223	C12 X 25 X 06	12	25	65	6	10,00 \$
3224	C16 X 25 X 06	16	25	65	6	17,50 \$

◆ D - Küre Başlı



Kod	Özellikler	Çap	Kesme Boyu	Boy	Arka Şaft	Fiyat
3225	D06 X 05 X 06	6	16	65	6	3,65 \$
3226	D08 X 07 X 06	8	20	65	6	5,00 \$
3227	D10 X 09 X 06	10	20	65	6	6,20 \$
3228	D12 X 10 X 06	12	25	65	6	9,00 \$
3229	D16 X 14 X 06	16	25	65	6	16,00 \$

◆ E - Oval Gövdeli



Kod	Özellikler	Çap	Kesme Boyu	Boy	Arka Şaft	Fiyat
3230	E06 X10 X 06	6	16	65	6	3,65 \$
3231	E08 X 13 X 06	8	20	65	6	5,00 \$
3232	E10 X 16 X 06	10	20	65	6	6,20 \$
3233	E12 X 20 X 06	12	25	65	6	9,00 \$
3234	E16 X 25 X 06	16	25	65	6	16,00 \$

◆ F - Küre Uçlu Çam



Kod	Özellikler	Çap	Kesme Boyu	Boy	Arka Şaft	Fiyat
3235	F06 X18 X 06	6	16	65	6	3,65 \$
3236	F08 X 20 X 06	8	20	65	6	5,00 \$
3237	F10 X 20 X 06	10	20	65	6	6,20 \$
3238	F12 X 25 X 06	12	25	65	6	8,30 \$
3239	F16 X 25 X 06	16	25	65	6	16,00 \$

◆ G - Sivri Çam



Kod	Özellikler	Çap	Kesme Boyu	Boy	Arka Şaft	Fiyat
3240	G06 X18 X 06	6	16	65	6	3,65 \$
3241	G08 X 20 X 06	8	20	65	6	5,00 \$
3242	G10 X 20 X 06	10	20	65	6	6,20 \$
3243	G12 X 25 X 06	12	25	65	6	9,00 \$
3244	G16 X 25 X 06	16	25	65	6	16,00 \$

◆ H - Alev



Kod	Özellikler	Çap	Kesme Boyu	Boy	Arka Şaft	Fiyat
3245	H06 X18 X 06	6	18	65	6	4,00 \$
3246	H08 X 20 X 06	8	20	65	6	5,30 \$
3247	H10 X 25 X 06	10	25	65	6	6,60 \$
3248	H12 X 32 X 06	12	32	65	6	10,00 \$
3249	H16 X 36 X 06	16	36	65	6	17,50 \$

◆ L - Konik Yuvarlak



Kod	Özellikler	Çap	Kesme Boyu	Boy	Arka Şaft	Fiyat
3250	L06 X16 X 06	6	16	65	6	3,65 \$
3251	L08 X 22 X 06	8	22	65	6	5,00 \$
3252	L10 X 25 X 06	10	25	65	6	6,20 \$
3253	L12 X 28 X 06	12	28	65	6	9,00 \$
3254	L16 X 33 X 06	16	33	65	6	16,00 \$

◆ M - Konik Sivri



Kod	Özellikler	Çap	Kesme Boyu	Boy	Arka Şaft	Fiyat
3255	M06 X18 X 06	6	18	65	6	3,65 \$
3256	M08 X 20 X 06	8	20	65	6	5,00 \$
3257	M10 X 20 X 06	10	20	65	6	6,20 \$
3258	M12 X 25 X 06	12	25	65	6	9,00 \$
3259	M16 X 25 X 06	16	25	65	6	16,00 \$

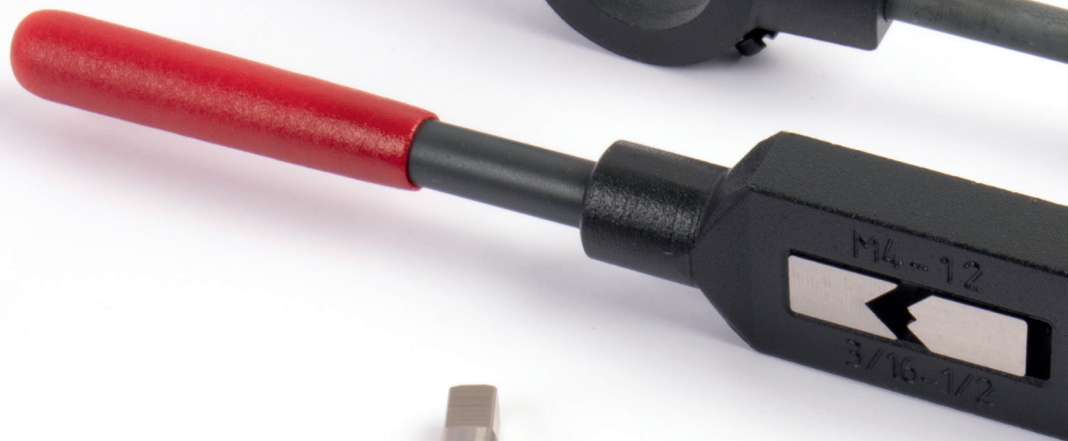

HSS Kılavuz ve Paftalar

- HSS 3'lü El Takım Kılavuzu
- HSS Titanyum Düz İnce Diş Makina Kılavuzu
- HSS Titanyum Düz Makina Kılavuzu
- HSS Titanyum Helis Makina Kılavuzu
- HSS 3'lü UNC ve UNF El Takım Kılavuzları
- HSS Tekli Son Kılavuz
- HSS Helikol Kılavuz
- HSS Titanyum UNC ve UNF Düz Makina Kılavuzu
- HSS Titanyum UNC ve UNF Helis Makina Kılavuzu
- HSS Kobalt Düz ve Helis Makina Kılavuzları
- Kılavuz Pafta Seti
- Ters Kılavuz Takımı
- Ters Musluk Kılavuzu
- HSS 2'li Gaz Diş Kılavuz
- HSS Tekli Gaz Diş Makina Kılavuzu
- HSS Metrik Paftalar
- HSS UNC ve UNF Paftalar
- HSS Gaz Diş Paftalar
- Kılavuz ve Pafta Kolları
- Mengereler
- Kalıp Bağlama Setleri

◆ HSS 3'lü Metrik El Takım Kılavuzu
DIN 352



Kod	Özellikler	Paket	Fiyat
3300	M - 3 x 0,5	20	5,90 \$
3301	M - 4 x 0,7	20	5,90 \$
3302	M - 5 x 0,8	20	6,00 \$
3303	M - 6 x 1,0	20	6,20 \$
3304	M - 8 x 1,25	20	6,90 \$
3305	M - 10 x 1,5	20	7,70 \$
3306	M - 12 x 1,75	20	13,00 \$
3307	M - 14 x 2,0	8	16,20 \$
3308	M - 16 x 2,0	8	18,00 \$
3309	M - 18 x 2,5	8	18,70 \$
3310	M - 20 x 2,5	8	19,25 \$
3311	M - 22 x 2,5	5	27,00 \$
3312	M - 24 x 3,0	4	37,50 \$
3313	M - 25 x 3,0	4	46,75 \$
3314	M - 27 x 3,0	4	59,00 \$
3315	M - 30 x 3,5	4	94,00 \$

◆ HSS Titanyum Düz İnce Diş Makina
Kılavuzu - DIN 371 / 376



Kod	Özellikler	DIN	Fiyat
3400	M - 8 x 1,0	371	4,20 \$
3401	M - 10 x 1,0	371	5,20 \$
3402	M - 10 x 1,25	371	5,20 \$
3403	M - 12 x 1,0	376	7,40 \$
3404	M - 12 x 1,25	376	7,40 \$
3405	M - 12 x 1,5	376	7,40 \$
3406	M - 14 x 1,0	376	9,30 \$
3407	M - 14 x 1,25	376	9,30 \$
3408	M - 14 x 1,5	376	9,30 \$
3409	M - 16 x 1,0	376	10,10 \$
3410	M - 16 x 1,5	376	10,10 \$
3411	M - 18 x 1,0	376	12,45 \$
3412	M - 18 x 1,5	376	12,45 \$
3413	M - 20 x 1,0	376	17,60 \$
3414	M - 20 x 1,5	376	17,60 \$
3415	M - 22 x 1,5	376	21,00 \$

◆ HSS Titanyum Düz Makina Kılavuzu
DIN 371 / 376

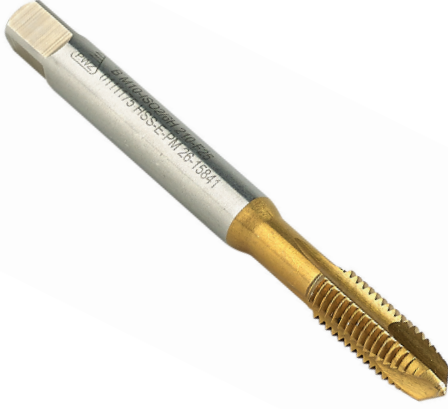

Kod	Özellikler	DIN	Paket	Fiyat
3497	M - 1,6 x 0,35	371	100	7,90 \$
3498	M - 2 x 0,4	371	100	6,85 \$
3499	M - 2,5 x 0,45	371	100	6,85 \$
3500	M - 3 x 0,5	371	100	3,10 \$
3501	M - 4 x 0,7	371	100	3,10 \$
3502	M - 5 x 0,8	371	50	3,40 \$
3503	M - 6 x 1,0	371	50	3,40 \$
3503-1	M - 7 x 1,0	371	50	4,00 \$
3504	M - 8 x 1,25	371	50	4,10 \$
3504-1	M - 9 x 1,25	371	50	5,00 \$
3505	M - 10 x 1,5	371	50	5,00 \$
3505-1	M - 11 x 1,5	371	50	7,20 \$
3506	M - 12 x 1,75	376	20	7,20 \$
3507	M - 14 x 2,0	376	25	9,25 \$
3508	M - 16 x 2,0	376	20	10,20 \$
3509	M - 18 x 2,5	376	8	12,45 \$
3510	M - 20 x 2,5	376	8	18,00 \$
3511	M - 22 x 2,5	376	8	20,00 \$
3512	M - 24 x 3,0	376	21	30,00 \$
3513	M - 27 x 3,0	376	18	39,00 \$
3514	M - 30 x 3,5	376	15	49,00 \$

◆ HSS Titanyum Helis Makina Kılavuzu
DIN 371/C - 376 35 Derece



Kod	Özellikler	DIN	Paket	Fiyat
3548	M - 2 x 0,4	371	100	8,00 \$
3549	M - 2,5 x 0,45	371	100	6,50 \$
3550	M - 3 x 0,5	371	100	3,30 \$
3551	M - 4 x 0,7	371	100	3,30 \$
3552	M - 5 x 0,8	371	50	3,85 \$
3553	M - 6 x 1,0	371	50	4,40 \$
3554	M - 8 x 1,25	371	50	5,20 \$
3555	M - 10 x 1,5	371	50	5,80 \$
3556	M - 12 x 1,75	376	20	8,00 \$
3557	M - 13 x 1,0	376	25	9,70 \$
3558	M - 14 x 2,0	376	25	10,50 \$
3559	M - 16 x 2,0	376	20	13,00 \$
3560	M - 18 x 2,5	376	8	15,00 \$
3561	M - 20 x 2,5	376	8	19,50 \$
3562	M - 22 x 2,5	376	16	28,00 \$
3563	M - 24 x 3,0	376	16	35,00 \$
3564	M - 27 x 3,0	376	9	45,00 \$

◆ HSS 3'lü El Takım Kılavuzu - DIN 351



Kod	Özellikler	UNC	Fiyat
3600	1/8 x 40	UNC	5,95 \$
3601	5/32 x 32	UNC	5,95 \$
3602	3/16 x 24	UNC	5,95 \$
3603	1/4 x 20	UNC	6,40 \$
3604	5/16 x 18	UNC	7,15 \$
3605	3/8 x 16	UNC	8,00 \$
3606	7/16 x 14	UNC	13,75 \$
3607	1/2 x 12	UNC	13,75 \$
3608	1/2 x 13	UNC	13,75 \$
3609	9/16 x 12	UNC	17,00 \$
3610	5/8 x 11	UNC	18,60 \$
3611	3/4 x 10	UNC	19,60 \$
3612	7/8 x 9	UNC	27,60 \$
3613	1" x 8	UNC	38,00 \$

◆ HSS 3'lü El Takım İnce Diş Kılavuz - DIN 351



Kod	Özellikler	UNF	Fiyat
3650	1/4 x 28	UNF	6,40 \$
3651	5/16 x 24	UNF	7,15 \$
3652	3/8 x 24	UNF	8,15 \$
3653	7/16 x 20	UNF	13,75 \$
3654	1/2 x 20	UNF	13,75 \$
3655	9/16 x 18	UNF	17,00 \$
3656	5/8 x 18	UNF	18,60 \$
3657	3/4 x 16	UNF	19,60 \$

◆ HSS Tekli Son Kılavuz - DIN 352



Kod	Özellikler	DIN	Paket	Fiyat
3580	M - 5 x 0,8	352	50	2,00 \$
3581	M - 6 x 1,0	352	100	2,10 \$
3582	M - 8 x 1,25	352	50	2,25 \$
3583	M - 10 x 1,5	352	50	2,60 \$
3584	M - 12 x 1,75	352	50	4,30 \$

◆ HSS Helikol Kılavuz - DIN 8141



Kod	Özellikler	DIN	Fiyat
3770	M - 5 X 0,8	8141	4,30 \$
3771	M - 6 X 1,0	8141	4,30 \$
3772	M - 7 X 1,0	8141	5,50 \$
3773	M - 8 X 1,0	8141	5,80 \$
3774	M - 8 X 1,25	8141	5,80 \$
3775	M - 10 X 1,0	8141	6,50 \$
3776	M - 10 X 1,25	8141	6,50 \$
3777	M - 10 X 1,50	8141	6,50 \$
3778	M - 12 X 1,25	8141	7,00 \$
3779	M - 12 X 1,50	8141	7,00 \$
3780	M - 12 X 1,75	8141	7,00 \$
3781	M - 14 X 1,25	8141	9,50 \$
3782	M - 14 X 1,50	8141	9,50 \$
3783	M - 16 X 1,50	8141	11,50 \$
3784	M - 18 X 1,50	8141	14,00 \$
3785	M - 20 X 1,50	8141	16,00 \$

◆ HSS Titanyum Düz Makina Kılavuzu
DIN - 371 / 376



Kod	Özellikler	UNC	Fiyat
3700	1/4 x 20	UNC	3,70 \$
3701	5/16 x 18	UNC	4,30 \$
3702	3/8 x 16	UNC	5,30 \$
3703	7/16 x 14	UNC	7,30 \$
3704	1/2 x 12	UNC	7,50 \$
3705	1/2 x 13	UNC	7,50 \$
3706	9/16 x 12	UNC	9,60 \$
3707	5/8 x 11	UNC	10,45 \$
3708	3/4 x 10	UNC	18,70 \$
3709	7/8 x 9	UNC	22,50 \$
3710	1" x 8	UNC	34,00 \$

◆ HSS Titanyum İnce Diş Düz Makina
Kılavuzu - DIN 371/376



Kod	Özellikler	UNF	Fiyat
3750	1/4 x 28	UNF	3,70 \$
3751	5/16 x 24	UNF	4,30 \$
3752	3/8 x 24	UNF	5,30 \$
3753	7/16 x 20	UNF	7,30 \$
3754	1/2 x 20	UNF	7,50 \$
3755	9/16 x 18	UNF	9,60 \$
3756	5/8 x 18	UNF	10,45 \$
3757	3/4 x 16	UNF	18,70 \$

◆ HSS Titanyum Helis Makina Kılavuzu -
DIN 371 / 376 - 35 Derece



Kod	Özellikler	UNC	Fiyat
3800	1/4 x 20	UNC	4,50 \$
3801	5/16 x 18	UNC	5,35 \$
3802	3/8 x 16	UNC	5,90 \$
3803	7/16 x 14	UNC	7,80 \$
3804	1/2 x 12	UNC	8,30 \$
3805	1/2 x 13	UNC	8,30 \$
3806	9/16 x 12	UNC	10,30 \$
3807	5/8 x 11	UNC	12,30 \$
3808	3/4 x 10	UNC	18,15 \$
3809	7/8 x 9	UNC	25,50 \$
3810	1" x 8	UNC	38,50 \$

◆ HSS Titanyum İnce Diş Helis Makina
Kılavuzu DIN - 371 / 376 - 35 Derece



Kod	Özellikler	UNF	Fiyat
3811	1/4 x 28	UNF	4,50 \$
3812	5/16 x 24	UNF	5,35 \$
3813	3/8 x 24	UNF	5,90 \$
3814	7/16 x 20	UNF	7,80 \$
3815	1/2 x 20	UNF	8,30 \$
3816	9/16 x 18	UNF	10,30 \$
3817	5/8 x 18	UNF	12,30 \$
3818	3/4 x 16	UNF	18,15 \$
3819	7/8 x 14	UNF	25,50 \$
3820	1" x 12	UNF	38,50 \$

◆ HSS E Kobalt Düz Makina Kılavuzu -
DIN 371/C - 376



Kod	Özellikler	DIN	Paket	Fiyat
3830	M - 3 x 0,5	371	100	4,80 \$
3831	M - 4 x 0,7	371	100	4,80 \$
3832	M - 5 x 0,8	371	50	5,20 \$
3833	M - 6 x 1,0	371	50	6,20 \$
3834	M - 8 x 1,25	371	50	9,00 \$
3835	M - 10 x 1,5	371	50	12,00 \$
3836	M - 12 x 1,75	376	35	19,00 \$

◆ HSS E Kobalt Helis Makina Kılavuzu -
DIN 371 / C - 376 35 Derece



Kod	Özellikler	DIN	Paket	Fiyat
3837	M - 3 x 0,5	371	100	5,00 \$
3838	M - 4 x 0,7	371	100	5,00 \$
3839	M - 5 x 0,8	371	50	5,50 \$
3840	M - 6 x 1,0	371	50	6,50 \$
3841	M - 8 x 1,25	371	50	9,50 \$
3842	M - 10 x 1,5	371	50	12,50 \$
3843	M - 12 x 1,75	376	25	20,00 \$



◆ HSS Gaz Diş 2'li El Takım Kılavuzu - DIN 5157



Kod	Özellikler	DIN	Fiyat
3850	G 1/8 x 28	5157	9,00 \$
3851	G 1/4 x 19	5157	13,50 \$
3852	G 3/8 x 19	5157	20,50 \$
3853	G 1/2 x 14	5157	29,00 \$
3854	G 5/8 x 14	5157	42,00 \$
3855	G 3/4 x 14	5157	55,00 \$
3856	G 7/8 x 14	5157	65,00 \$
3857	G 1" x 11	5157	80,00 \$

◆ HSS Gaz Diş Tekli Makina Kılavuzu - DIN 5156



Kod	Özellikler	DIN	Fiyat
3900	G 1/8 x 28	5156	4,50 \$
3901	G 1/4 x 19	5156	8,00 \$
3902	G 3/8 x 19	5156	12,00 \$
3903	G 1/2 x 14	5156	17,00 \$
3904	G 5/8 x 14	5156	26,00 \$
3905	G 3/4 x 14	5156	35,00 \$
3906	G 7/8 x 14	5156	48,00 \$
3907	G 1" x 11	5156	55,00 \$



◆ HSS Metrik Pafta



Kod	Özellikler	Fiyat
4000	M - 3 x 0,5	2,50 \$
4001	M - 4 x 0,7	2,50 \$
4002	M - 5 x 0,8	2,70 \$
4003	M - 6 x 1,0	3,20 \$
4004	M - 8 x 1,25	3,85 \$
4005	M - 10 x 1,5	7,50 \$
4006	M - 12 x 1,75	9,80 \$
4007	M - 14 x 2,0	9,80 \$
4008	M - 16 x 2,0	16,00 \$
4009	M - 18 x 2,5	17,00 \$
4010	M - 20 x 2,5	18,00 \$
4011	M - 22 x 2,5	29,00 \$
4012	M - 24 x 3,0	30,00 \$
4013	M - 27 x 3,0	43,00 \$
4014	M - 30 x 3,5	44,00 \$

◆ HSS Metrik İnce Diş Pafta



Kod	Özellikler	Fiyat
4050	M - 8 x 1,0	3,85 \$
4051	M - 10 x 1,0	7,50 \$
4052	M - 10 x 1,25	7,50 \$
4053	M - 12 x 1,25	9,80 \$
4054	M - 12 x 1,50	9,80 \$
4055	M - 14 x 1,25	9,80 \$
4056	M - 14 x 1,50	9,80 \$
4057	M - 16 x 1,50	16,00 \$
4058	M - 18 x 1,25	17,00 \$
4059	M - 18 x 1,50	17,00 \$
4060	M - 20 x 1,50	18,00 \$
4061	M - 20 x 2,0	18,00 \$
4062	M - 22 x 1,50	29,00 \$
4063	M - 22 x 1.25	29,00 \$

◆ HSS UNC Kalın Diş Pafta



Kod	Özellikler	Fiyat
4100	1/4 x 20	3,40 \$
4101	5/16 x 18	3,85 \$
4102	3/8 x 16	7,70 \$
4103	7/16 x 14	9,90 \$
4104	1/2 x 12	9,90 \$
4105	1/2 x 13	9,90 \$
4106	9/16 x 12	13,20 \$
4107	5/8 x 11	17,05 \$
4108	3/4 x 10	17,60 \$
4109	7/8 x 9	31,00 \$
4110	1" x 8	32,00 \$

◆ HSS UNF İnce Diş Pafta



Kod	Özellikler	Fiyat
4120	1/4 x 28	3,40 \$
4121	5/16 x 24	3,85 \$
4122	3/8 x 24	7,70 \$
4123	7/16 x 20	9,90 \$
4124	1/2 x 20	9,90 \$
4125	9/16 x 18	13,20 \$
4126	5/8 x 18	17,05 \$
4127	3/4 x 16	17,60 \$
4128	7/8 x 14	31,00 \$
4129	1" x 12	32,00 \$

◆ HSS Gaz Diş Pafta - DIN 5158

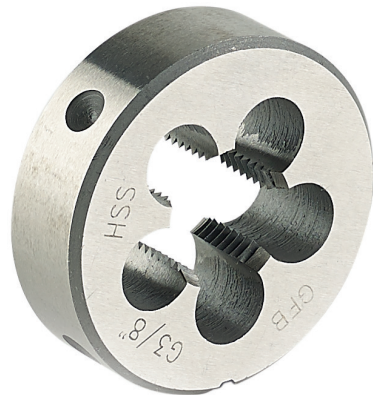

Kod	Özellikler	Fiyat
4130	G 1/8 x 28	10,00 \$
4131	G 1/4 x 19	13,00 \$
4132	G 3/8 x 19	21,00 \$
4133	G 1/2 x 14	26,60 \$
4134	G 5/8 x 14	36,00 \$
4135	G 3/4 x 14	39,00 \$
4136	G 7/8 x 14	65,00 \$
4137	G 1" x 11	69,00 \$

◆ 40 Parçalı Kılavuz - Pafta Seti



YENİ ÜRÜN

Kod	Özellikler	Fiyat
3960	Kılavuz - Pafta Seti	43,00 \$

◆ Ters Kılavuz Seti



YENİ ÜRÜN

◆ Ağır Hizmet

◆ Hafif Hizmet

Kod	Özellikler	Fiyat
3950	5 Parçalı - Hafif Hizmet	5,50 \$
3951	6 Parçalı - Hafif Hizmet	6,30 \$
3955	5 Parçalı - Ağır Hizmet	6,20 \$
3956	6 Parçalı - Ağır Hizmet	8,50 \$

◆ Ters Musluk Kılavuzu



M35 - M50 (Büyük Boy)



M25 - M35 (Küçük Boy)

YENİ ÜRÜN

◆ Musluk tesisat kırığı çıkarmak için uygundur.

Kod	Özellikler	Fiyat
3970	M 25 - M 35	3,00 \$
3971	M 35 - M 50	4,00 \$

◆ Cırcırlı Kılavuz Kolu (Kısa)



Kod	Özellikler	Paket	Fiyat
4150	NO 1 M 3 - M 8	10	8,40 \$
4151	NO 2 M 5 - M 12	10	11,80 \$

Plastik blister ambalajlıdır.

◆ Cırcırlı Kılavuz Kolu (Uzun)



Kod	Özellikler	Paket	Fiyat
4200	NO 1 M 3 - M 8	8	12,30 \$
4201	NO 2 M 5 - M 12	8	15,30 \$

Plastik blister ambalajlıdır.

◆ Kılavuz Kolu



Kod	Özellikler	Koli	Fiyat
4250	NO 1 M 3 - M 10	50	6,70 \$
4251	NO 2 M 4 - M 12	40	9,20 \$
4252	NO 3 M 5 - M 20	30	15,20 \$
4253	NO 4 M 9 - M 27	20	21,50 \$

◆ Pafta Kolu



Kod	Özellikler	Koli	Fiyat
4300	NO 20 M 4 - M 6	50	4,90 \$
4301	NO 25 M 7 - M 9	40	6,30 \$
4302	NO 30 M 10 - M 11	40	8,00 \$
4303	NO 38 M 12 - M 14	20	9,30 \$
4304	NO 45 M 16 - M 20	15	13,50 \$
4305	NO 55 M 22 - M 24	10	21,50 \$

◆ Süper Hassas Tezgaah Mengenesi

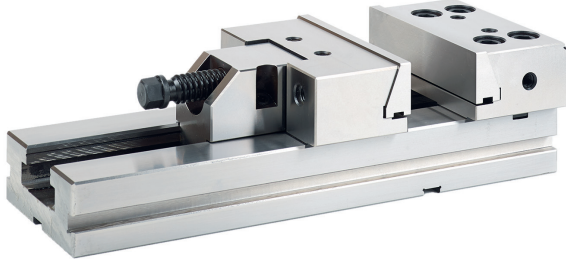

- ◆ Yüksek kaliteli alaşımlı çelikten üretilmiştir.
- ◆ Paralellik toleransı 0,005 mm / 100 mm'dir.
- ◆ Çalışma yüzeyleri hrc 58-62 sertleştirilip hassas taşlanmıştır.
- ◆ Hareketli çene hızlı ayarlanabilir ve kolay kullanılır.
- ◆ Cnc işleme merkezlerinde ve diğer hassas tezgahlarda kullanılır.
- ◆ Karton ve dayanıklı tahta kutudadır.

Kod	Özellikler	Max. Açılma	Fiyat
4350	175 x 200 mm	200 mm	820,00 \$
4351	175 x 300 mm	300 mm	890,00 \$
4352	200 x 300 mm	300 mm	1.345,00 \$
4353	200 x 400 mm	400 mm	1.550,00 \$

◆ Freze Mengenesi

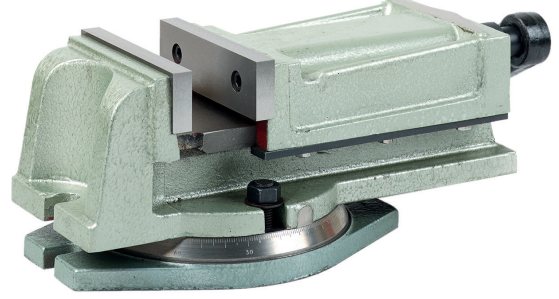

Kod	Özellikler	Max. Açılma	Fiyat
4360	OH 160 mm	125 mm	210,00 \$
4361	OH 200 mm	160 mm	285,00 \$

Köpüklü karton kutudadır.

◆ İki Açılı Mengene



- ◆ Ağır dökme demir gövdelidir.
- ◆ Her iki doğrultuda ölçek mevcuttur.
- ◆ Z doğrultusunda tabla 360°'likdir.
- ◆ Dikey ve yatay hareketi 90°'dir.
- ◆ Köpüklü karton kutudadır.

Kod	Özellikler	Max. Açılma	Fiyat
4370	OHK 160 mm	125 mm	265,00 \$

◆ Kalıp Bağlama Seti (52 Parçalı)

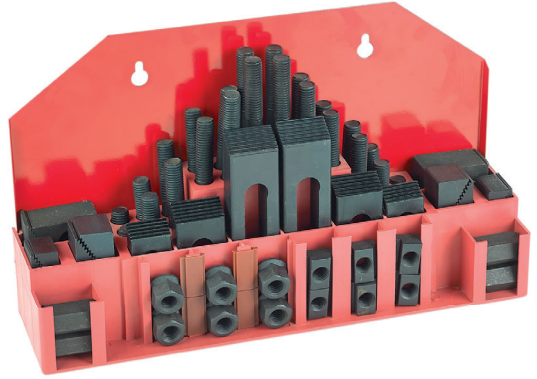

Kod	Ölçü	Özellikler	Fiyat
4450	M 10	M 10 x 1,25	63,00 \$
4451	M 12	M 12 x 1,75	77,00 \$
4452	M 14	M 14 x 2,0	84,00 \$
4453	M 16	M 16 x 2,0	97,00 \$
4454	M 18	M 18 x 2,5	210,00 \$

Sanal pos ödeme sistemimiz açılmıştır.



adresinden yeni kayıt açarak ödemelerinizi yapabilirsiniz.

WORLD 6 taksit

 6 taksit

AXESS 3 ve 6 taksit

maximum 4 taksit

 6 taksit

BANKALAR; ÖDEME ANINDA TAKSİT SEÇENEKLERİNDE DEĞİŞİKLİK YAPABİLİRLER.

www.gfb.com.tr